

Adında "t" sesi bulunan varlıkları boyayalım.

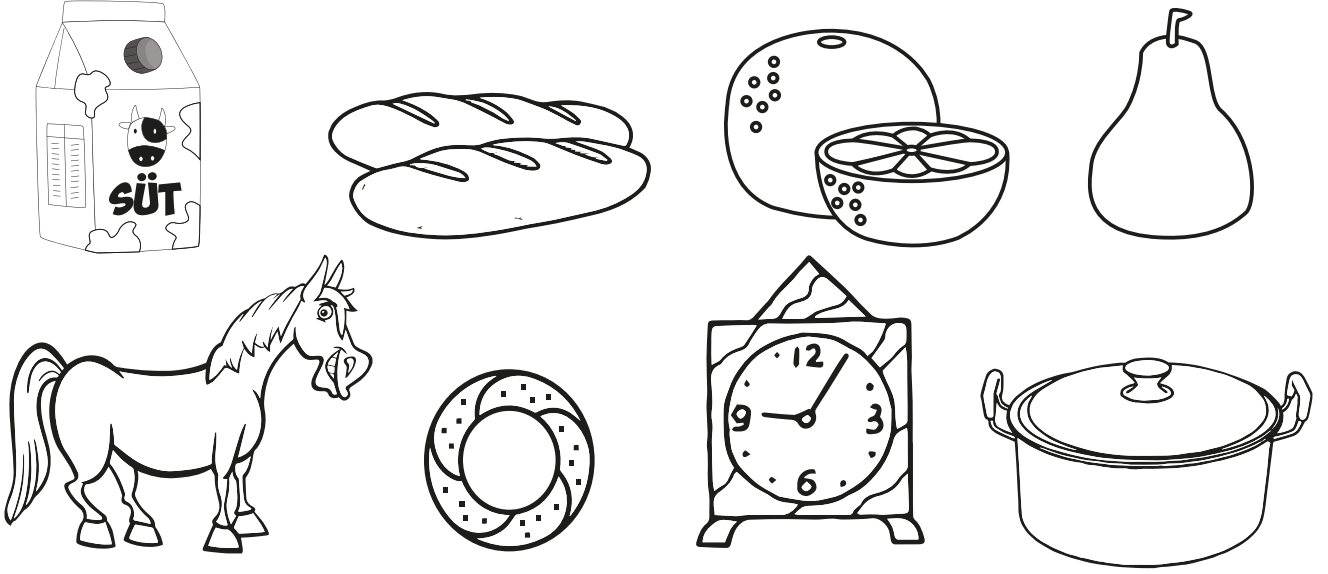

"t" sesi ile başlayan varlıkları işaretleyelim.





☞ Küçük "t" harfinin yazılış yönüne dikkat edelim. İçinden kalemimizle geçelim.

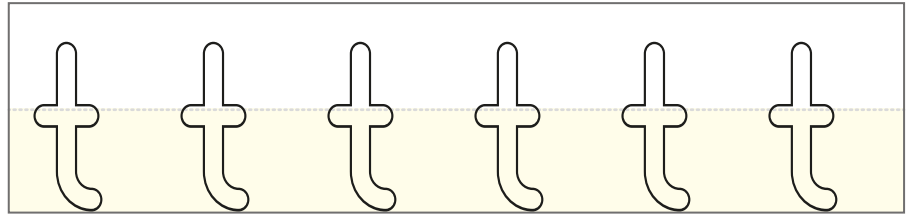
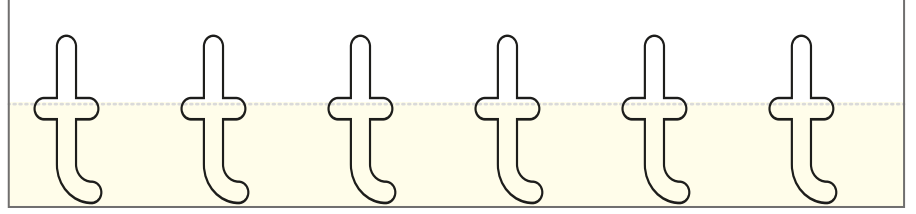
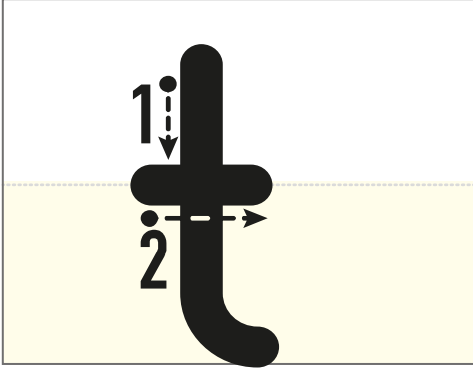

☞ "t" harfinin yazılı olduğu yıldızları boyayalım.



Yönergeleri uygulayalım.

• "t" harfini boyayalım.

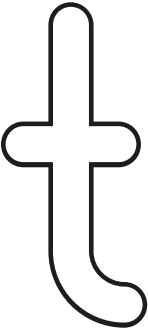

• "t" harflerini bulup yuvarlak içine alalım.

p t e t
e n t a
t n a e
t t n

• Noktaları birleştirelim.

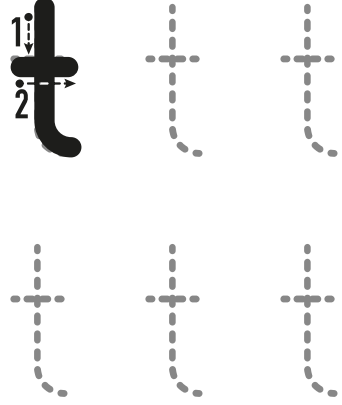

Yazma yönlerine dikkat ederek "t" harfini yazalım.

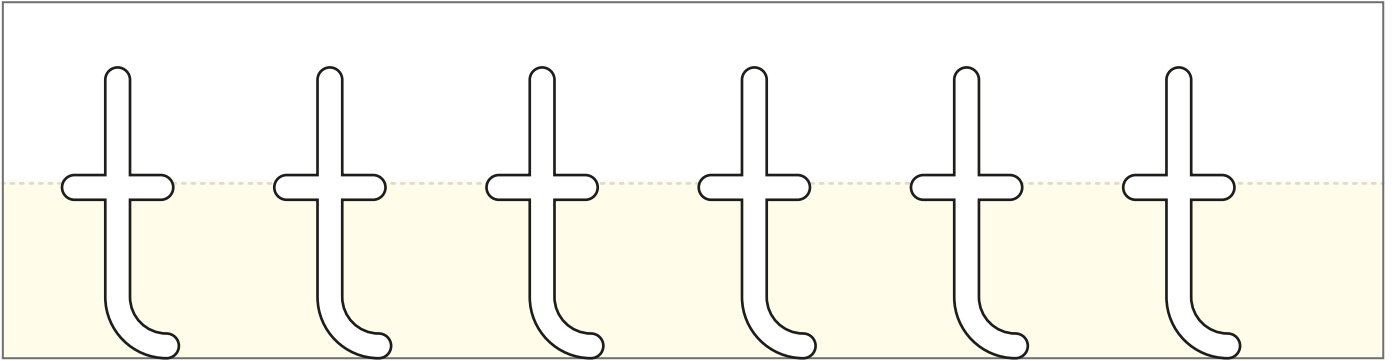



☞ "t" harfini yazalım.

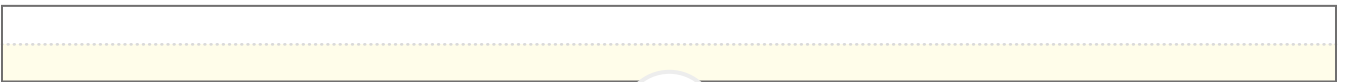
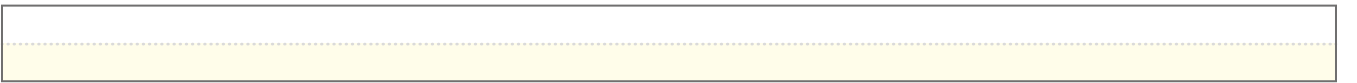
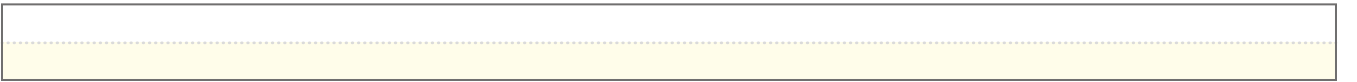
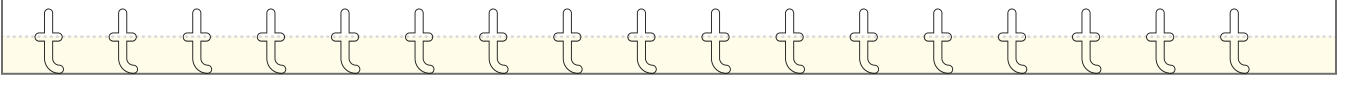



☞ Büyük "T" harfinin yazılış yönüne dikkat edelim. İçinden kalemimizle geçelim.

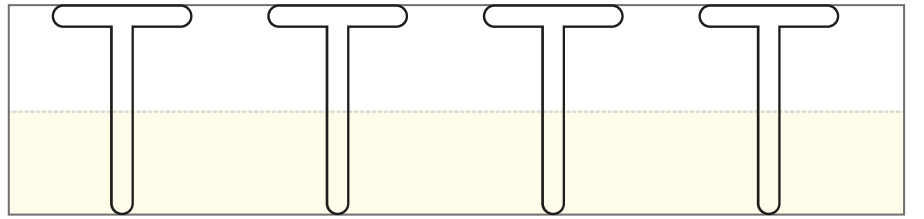
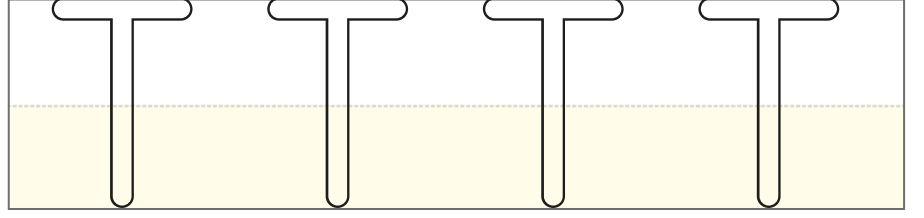
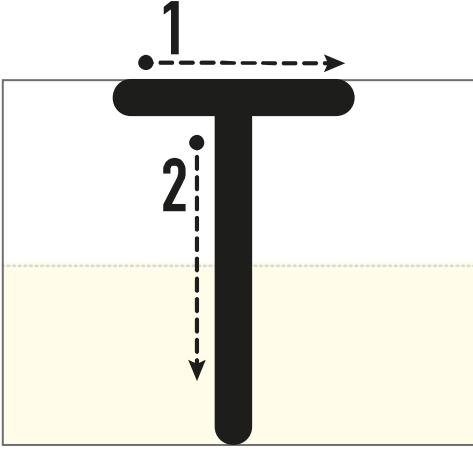

☞ "T" harfinin yazılı olduğu balonları boyyalım.

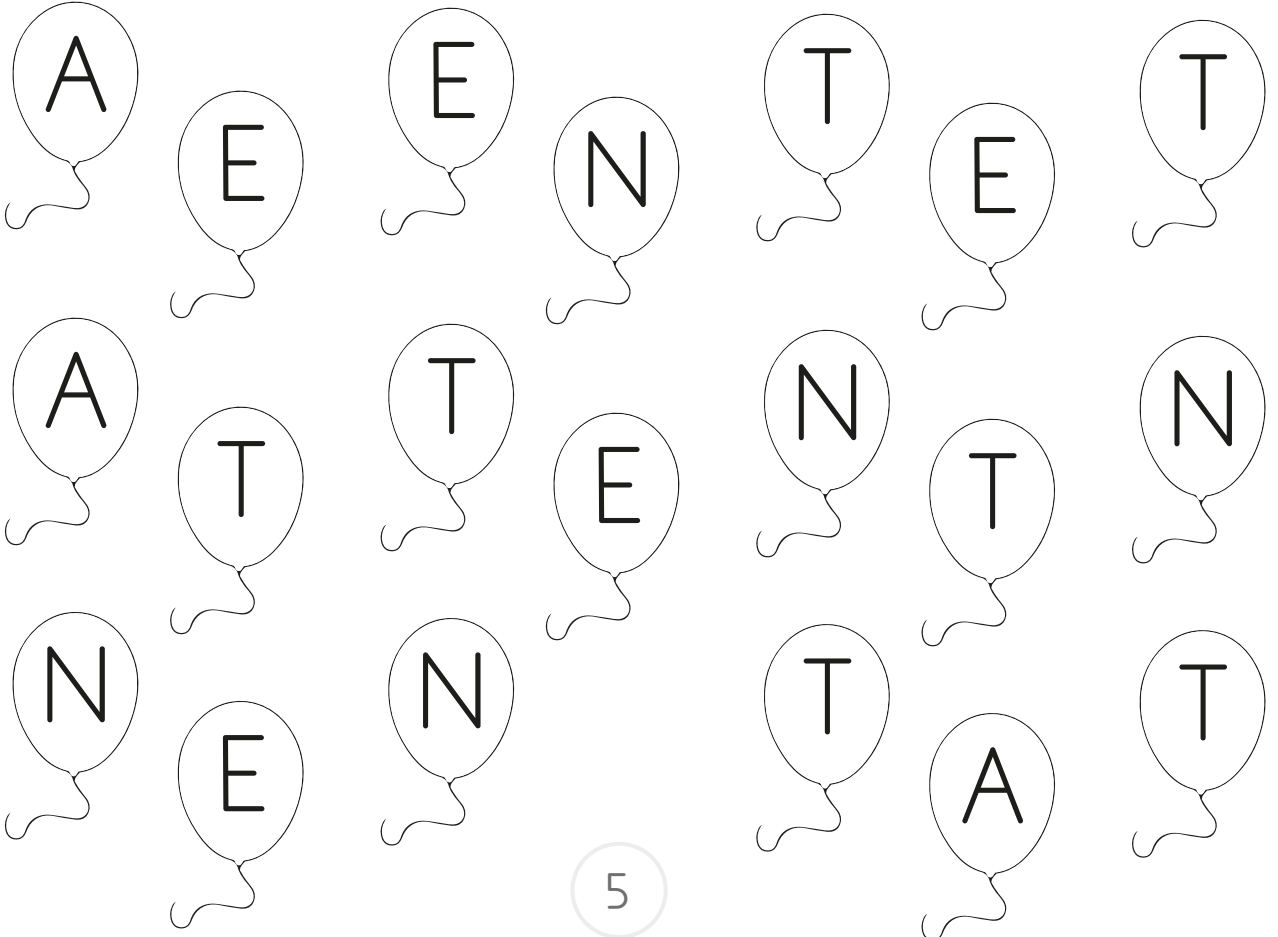



Yönergeleri uygulayalım.

• "T" harfini boyayalım.

• "T" harflerini bulup yuvarlak içine alalım.

n b A T T
T n
s E e T
T a N s

• Noktaları birleştirelim.

Yazma yönlerine dikkat ederek "T" harfini yazalım.

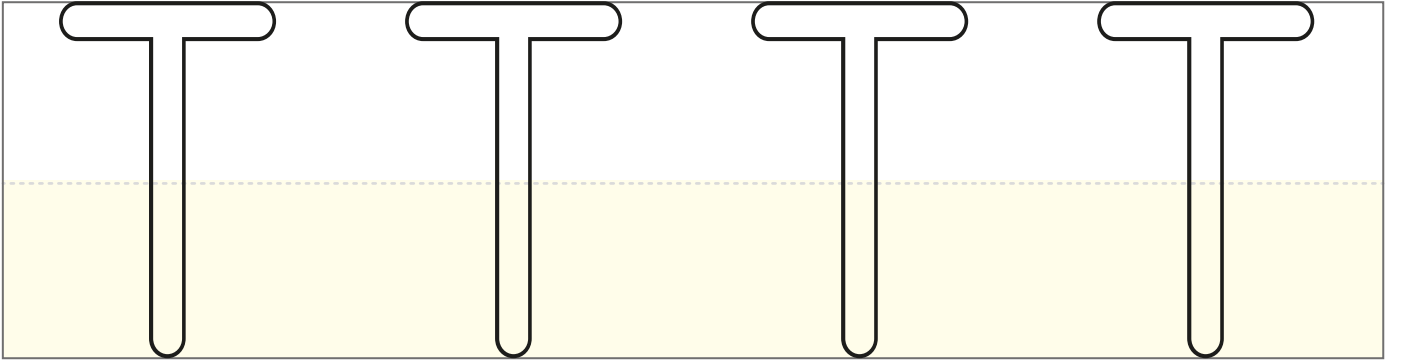



☞ "T harfini yazalım."

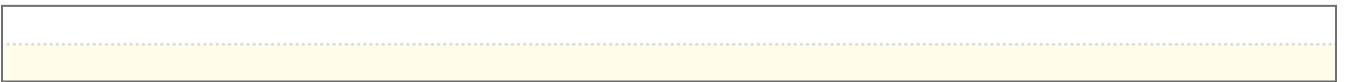
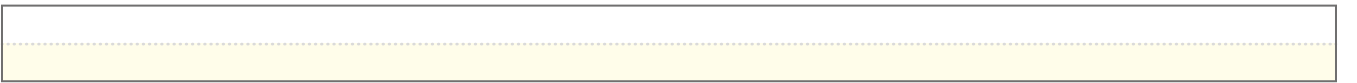
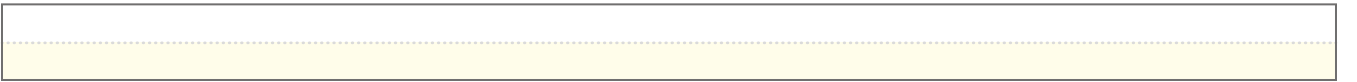
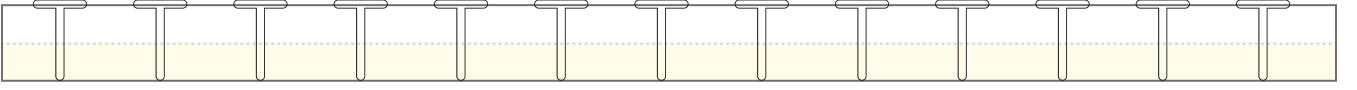

Boyayalım.

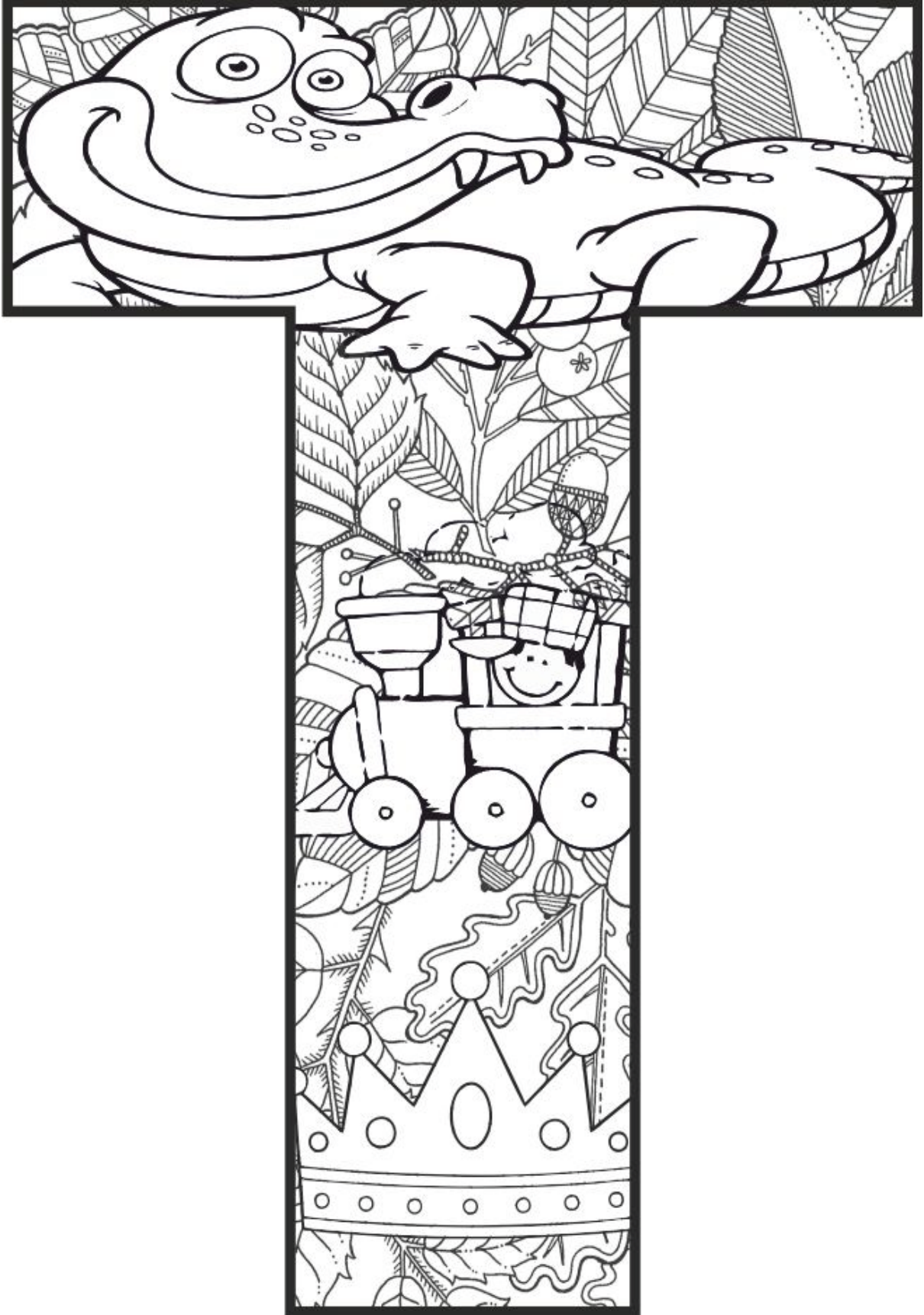



👉 Küçük "t" ve büyük "T" ve harfini yazalım.

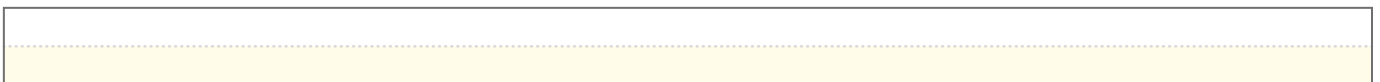
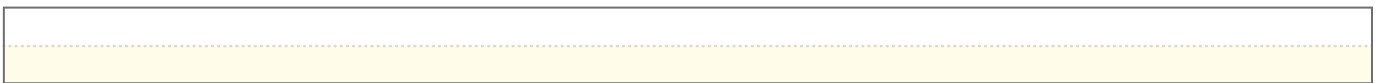
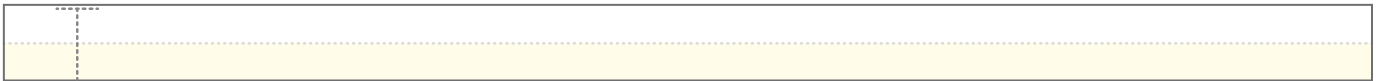
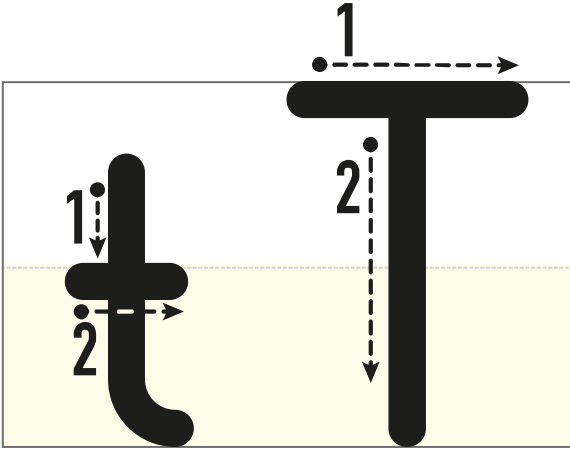



Okuyalım, yazalım.

a t at at at at

Blank handwriting practice line with a dashed midline.

Blank handwriting practice line with a dashed midline.

t a ta ta ta ta

Blank handwriting practice line with a dashed midline.

Blank handwriting practice line with a dashed midline.

e t et et et et

Blank handwriting practice line with a dashed midline.

Blank handwriting practice line with a dashed midline.

t e te te te te

Blank handwriting practice line with a dashed midline.

Blank handwriting practice line with a dashed midline.



☞ Görselleri inceleyelim. Varlıkların adındaki "t" harfi kadar şekil boyayalım.

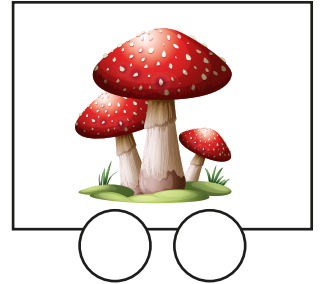
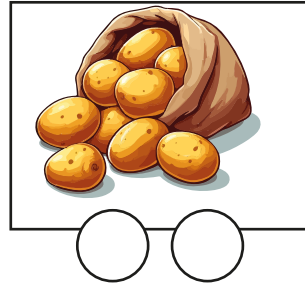
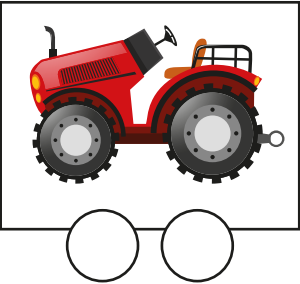
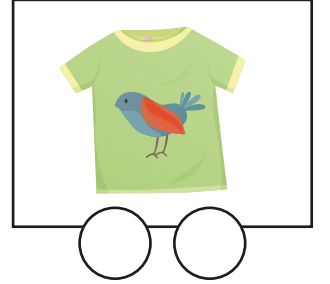
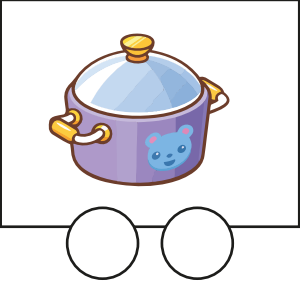
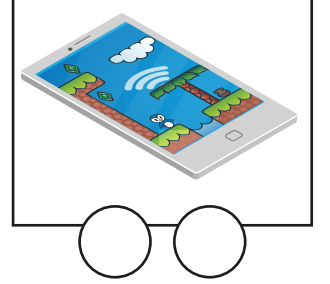
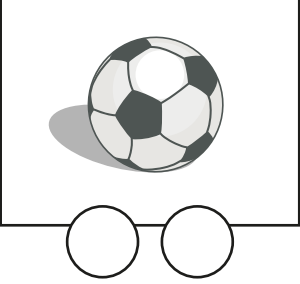

☞ Görseller ile kelimeleri eşleştirelim.

anten

at

tat

et

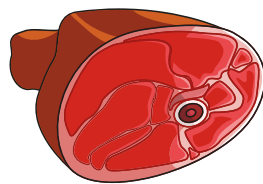
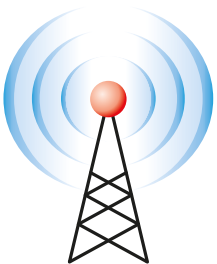



Okuyalım, yazalım.

a	ta	Ata	
ta	t	tat	
ta	n	Tan	
a	tan	atan	

Küçük "t" harfini takip ettirerek tavşanı annesine ulaştıralım.

t	t	t	T	N
T	t	t	e	T
A	t	t	a	N
e	t	t	t	t
T	n	T	n	t



👉 Harfleri birleştirerek kelimeler oluşturalım.

a

a

t

t

t

n

t

a

a

👉 Okuyalım, yazalım.

at

at

et

et

tat

tat

ant

ant

tane



👉 Aynı hece ve kelimelerin üzerini aynı renk kalemle çizelim.

attan	nat	at	ete	et
net	tane	et	tat	anten
tane	anten	tat	ete	ata
at	nat	attan	net	ata

👉 Harfleri karışık olarak verilen kelimeler yazalım.

t a A a t t n a t

e t n a n e t

n t a n e



Yönergeleri uygulayalım.

- Adı "t" sesi ile başlayan varlıkların görselini sayfanın aşağısındaki görsellerden kesip yapıştıralım.

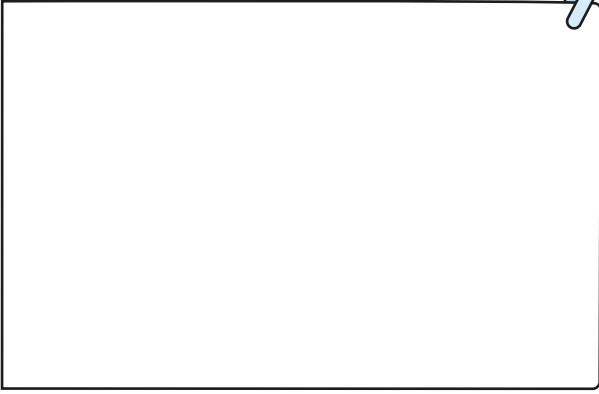

- Adı "t" sesi ile biten varlıkların görselini sayfanın aşağısındaki görsellerden kesip yapıştıralım.

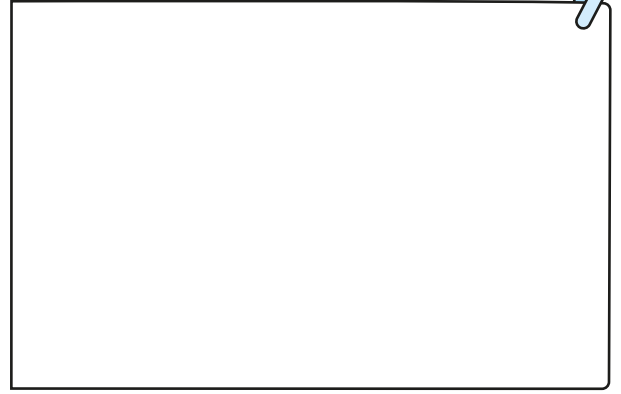

- Adında en çok "t" sesi olan görseli boyayalım.

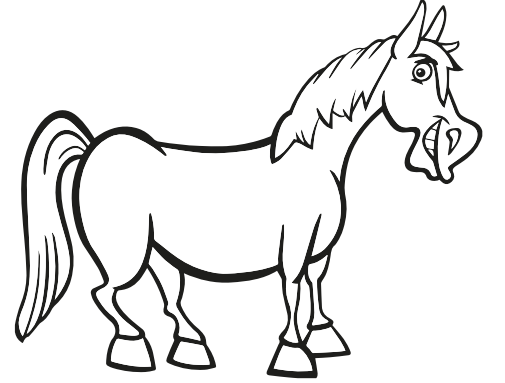
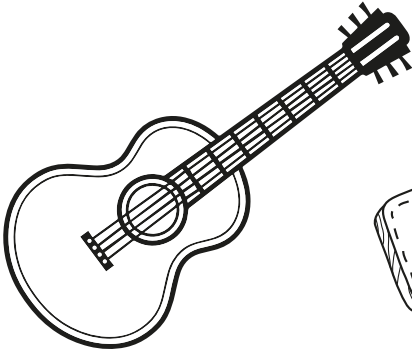

- Küçük "t" yazalım.

- Büyük "T" yazalım.

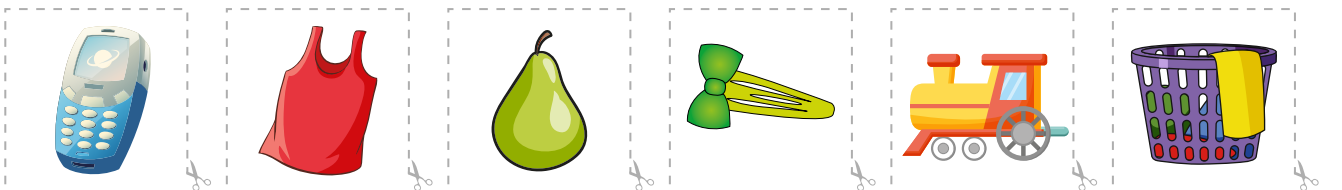



👉 4 rakamını yazalım.

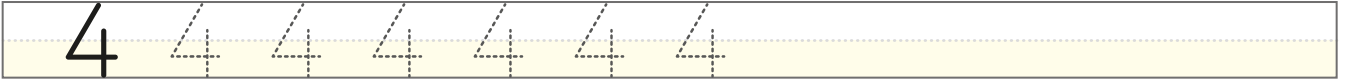
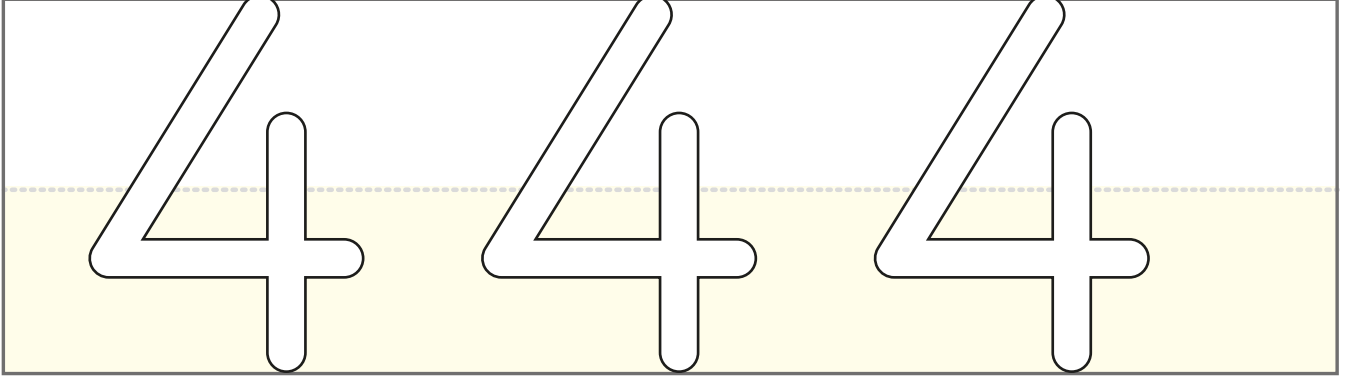

MATEMATİK

1

2

3

4

5

6

7

8

+

-

9

0

÷

×

=

?



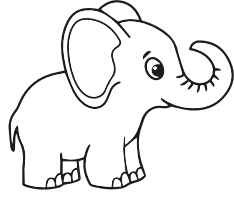
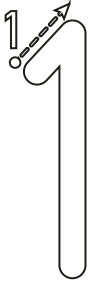

1 1 1 1

1 elma boyayalım.

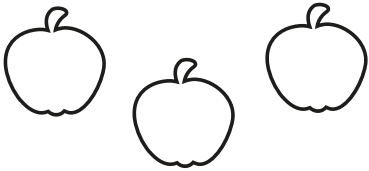

1 top çizelim.

1 tane "N" yazalım.

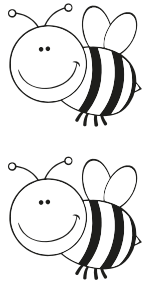
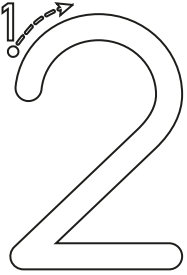

2 2 2 2

2 erik boyayalım.

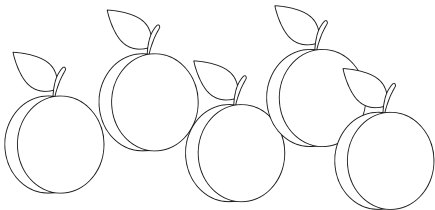

2 kalem çizelim.

2 tane "İ" yazalım.

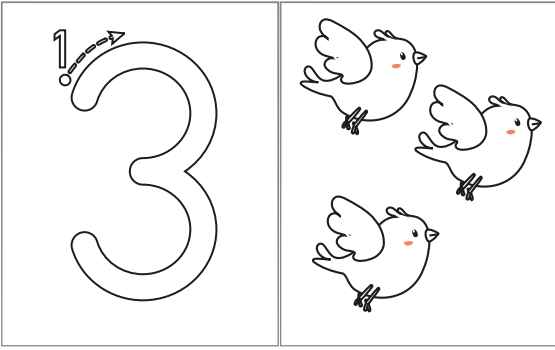

3 3 3 3

3 ev boyayalım.



3 kalp çizelim.

3 tane "L" yazalım.

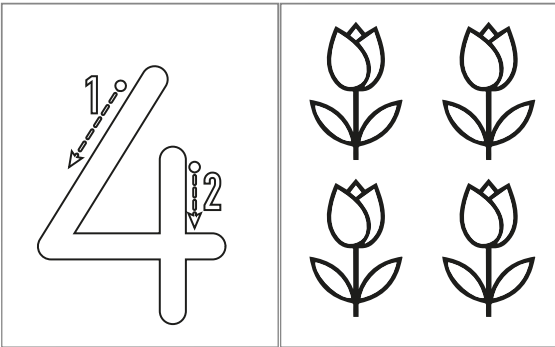

4 4 4 4

4 armut boyayalım.

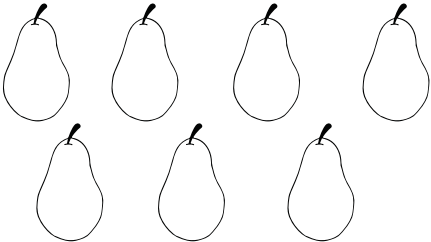

4 yıldız çizelim.

4 tane "E" yazalım.

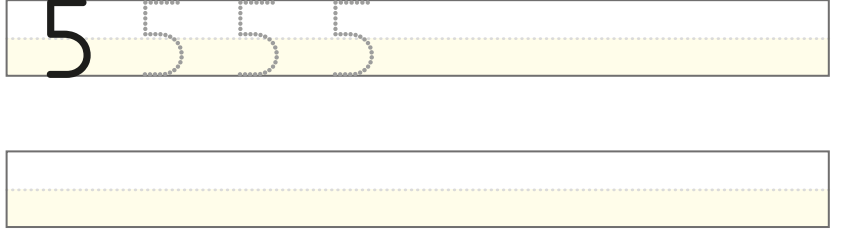
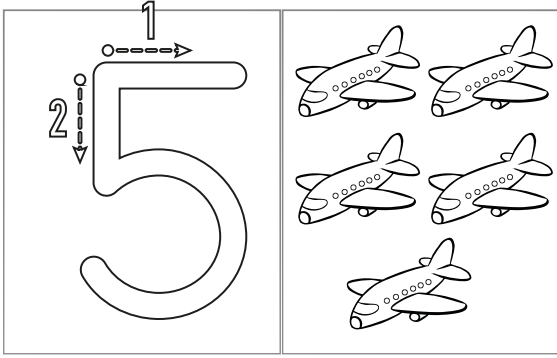

5 çilek boyayalım.

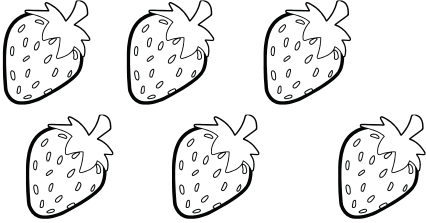

5 ay çizelim.

5 tane "A" yazalım.

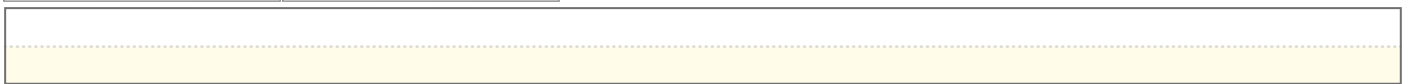
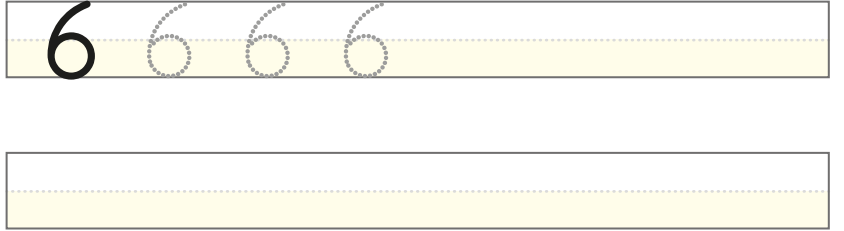
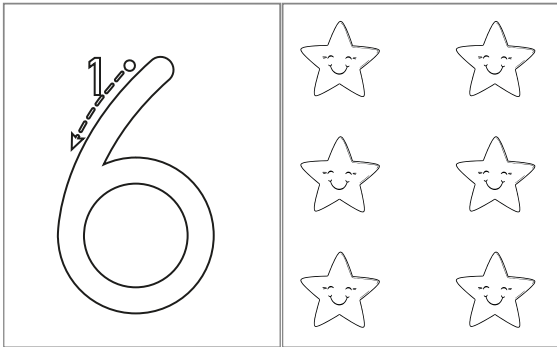
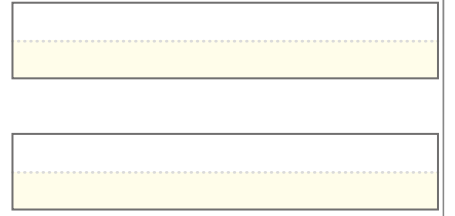

6 defter boyayalım.

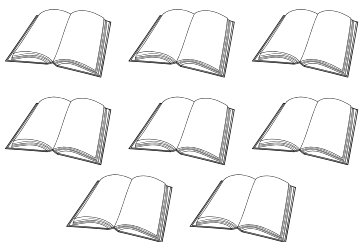

6 güneş çizelim.

6 tane "K" yazalım.

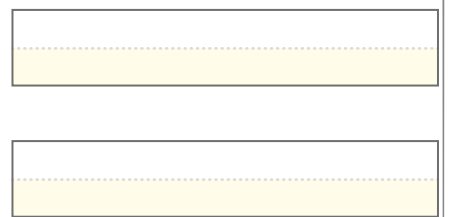

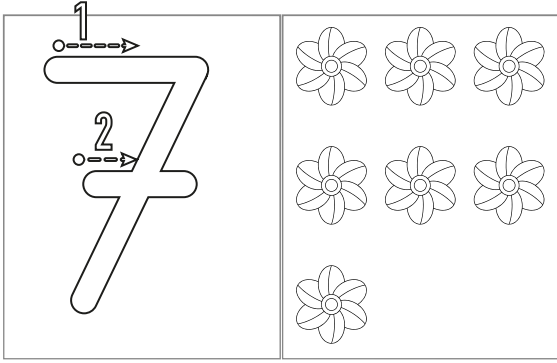

7 kedi boyayalım.

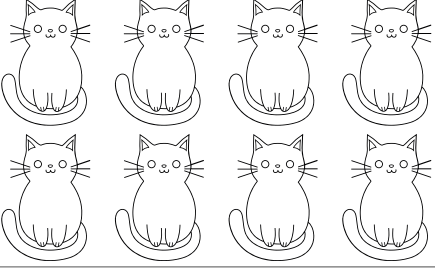

7 portakal çizelim.

7 tane "N" yazalım.

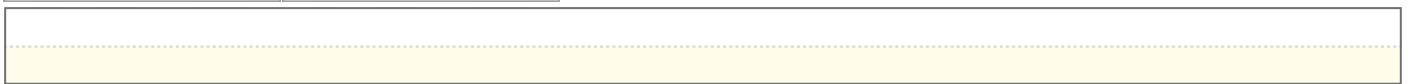
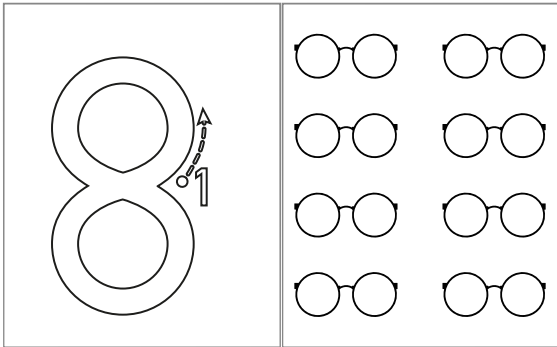
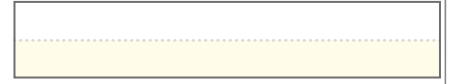

8 çanta boyayalım.



8 çiçek çizelim.

8 tane "İ" yazalım.



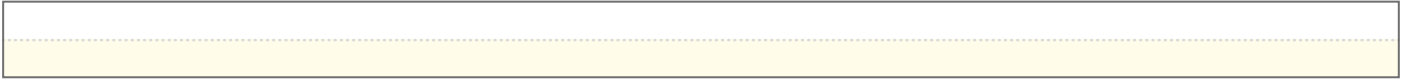
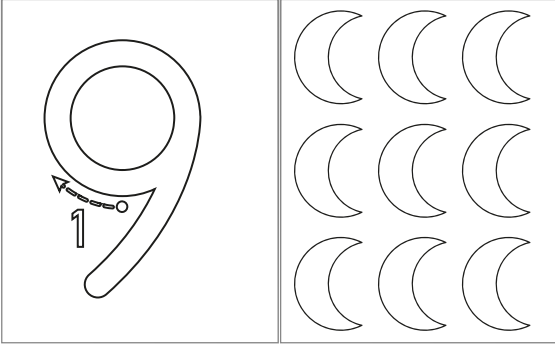

9 çiçek boyayalım.

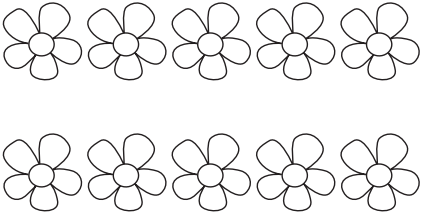

9 muz çizelim.

9 tane "L" yazalım.

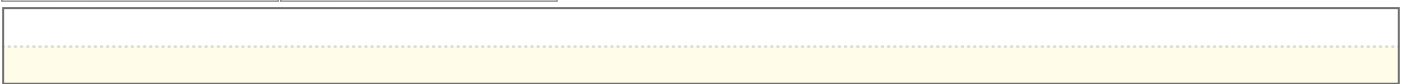
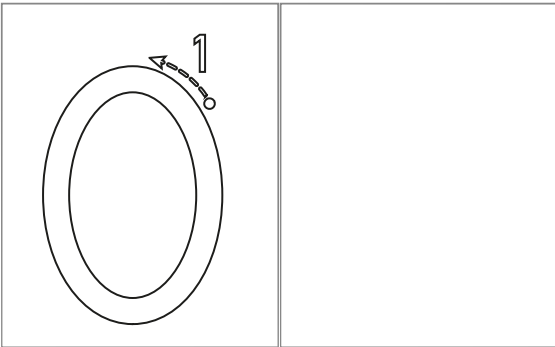

0 gül boyayalım.

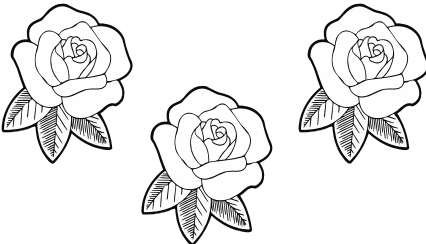

0 çocuk çizelim.

0 tane "E" yazalım.

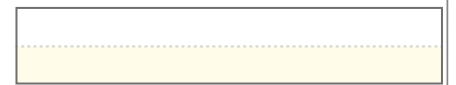



👉 Varlıkların sayısını yazalım.

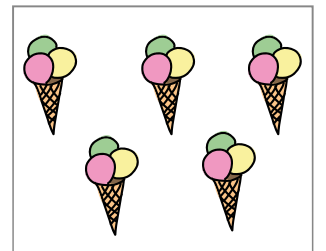
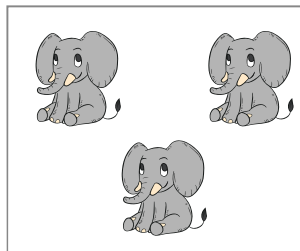
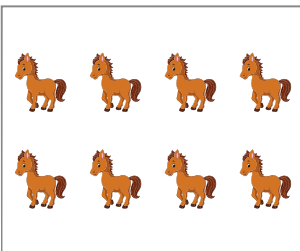
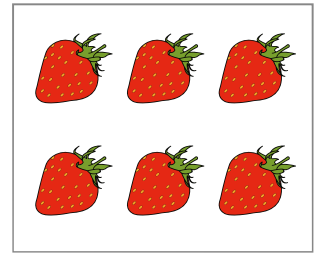
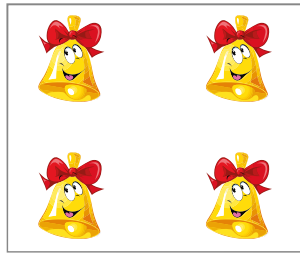
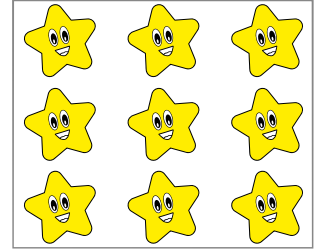
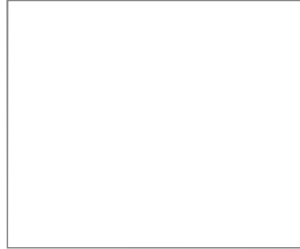
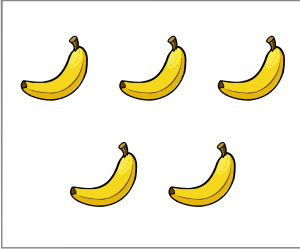
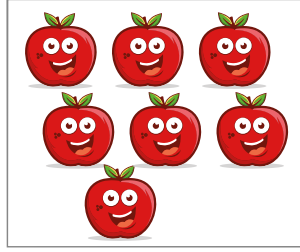
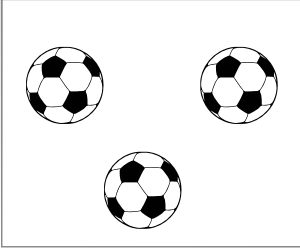



👉 Aşağıdaki varlıkları nesne sayılarıyla eşleştirelim.

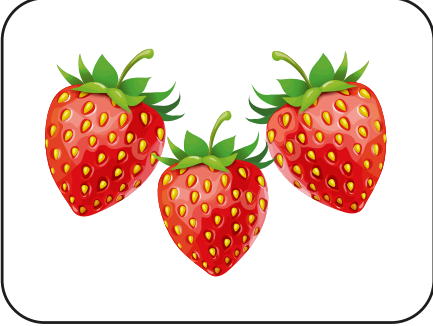

5

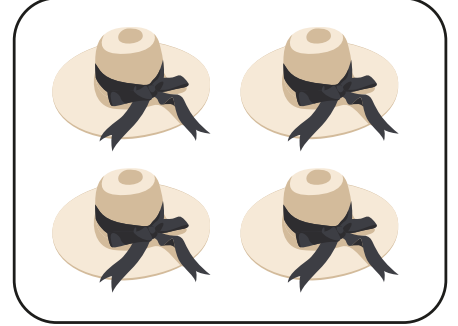

8

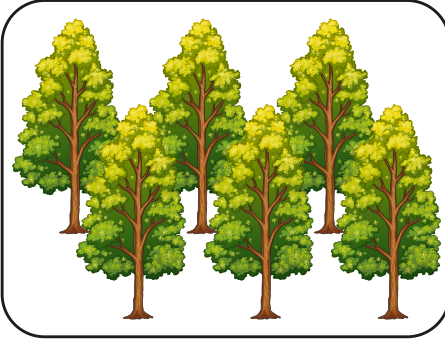

3

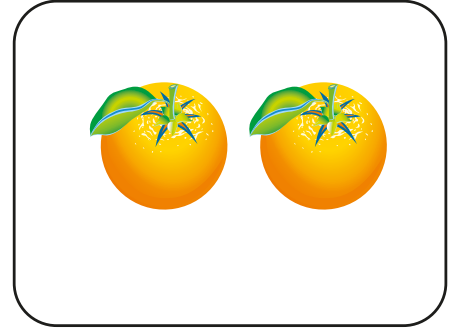

1



4

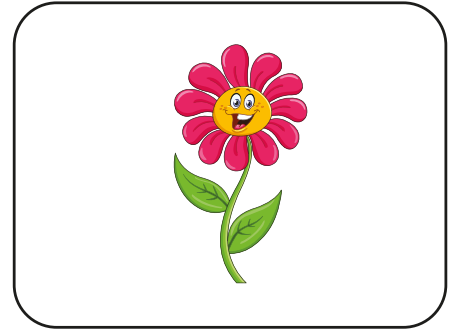

7

6

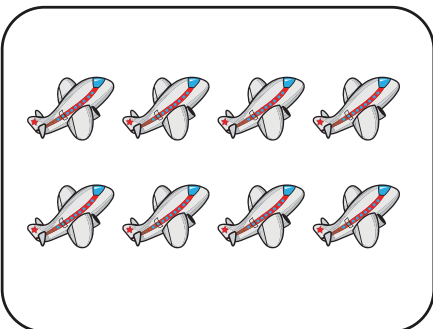

2

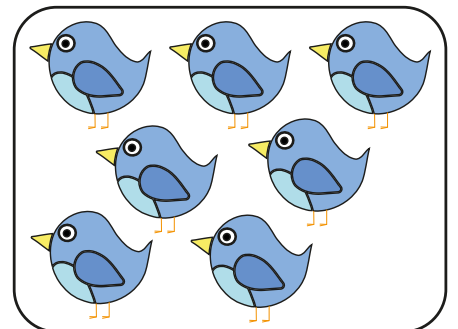

7

Varlıkların sayısını yazalım.

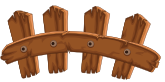
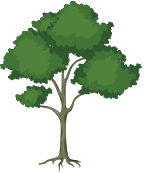

4 EKİM

DÜNYA HAYVANLARI
KORUMA GÜNÜ

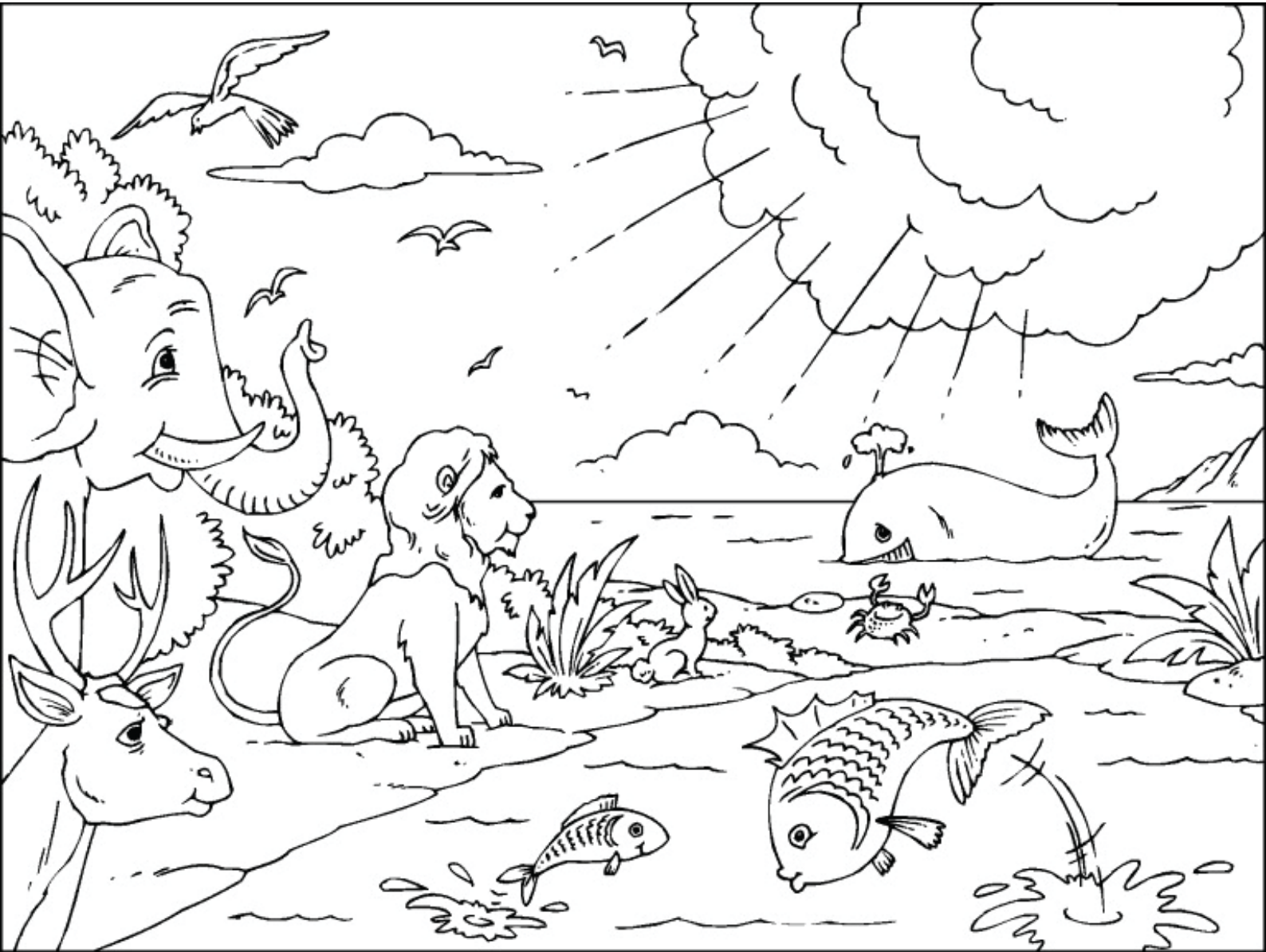



Etkinlik: Sizce sokak hayvanları için neler yapabiliriz? Yazalım.

Four horizontal dotted lines for writing, enclosed in a decorative green border with leaf motifs at the corners.

Etkinlik: Aşağıda sokak hayvanları besleme çizelgesi verilmiştir. Besleme yaptığınız her gün için bir tik atınız. Diğer sayfayı da en yakın arkadaşınıza veriniz.

	PAZARTESİ	SALI	ÇARŞAMBA	PERŞEMBE	CUMA	CUMARTESİ	PAZAR
1. HAFTA							
2. HAFTA							
3. HAFTA							
4. HAFTA							
5. HAFTA							
6. HAFTA							
7. HAFTA							



