



U VE T SESİ ÇALIŞMALARI



👉 Adında "u" sesi bulunan varlıkları boyayalım.



👉 "u" sesi ile başlayan varlıkları işaretleyelim.





👉 Büyük "U" harfinin yazılış yönüne dikkat edelim. İçinden kalemimizle geçelim.

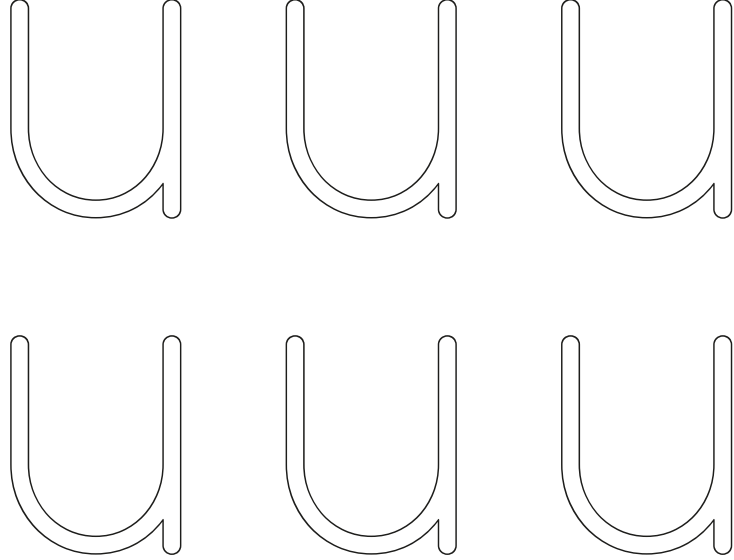
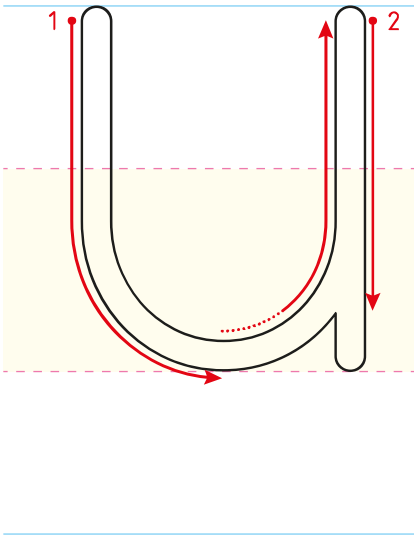

👉 "U" harfinin yazılı olduğu balonları boyayalım.

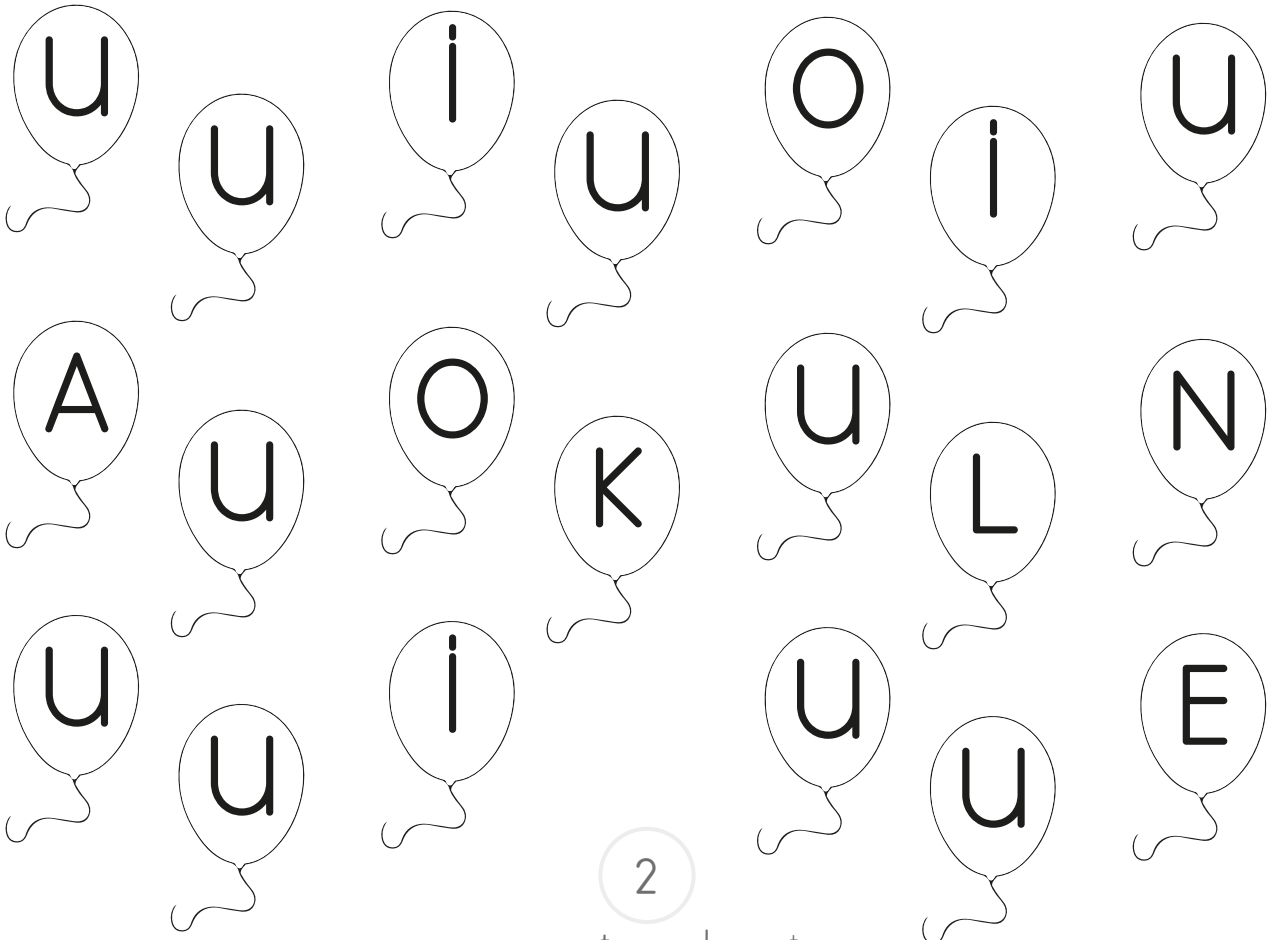

Yönergeleri uygulayalım.

• "U" harfini boyayalım.

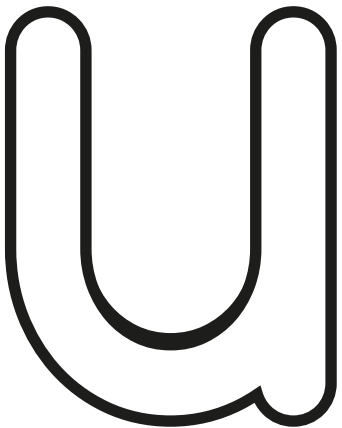

• "U" harflerini bulup yuvarlak içine alalım.

N U o U
k e U
u o a
y A u u

• Noktaları birleştirelim.

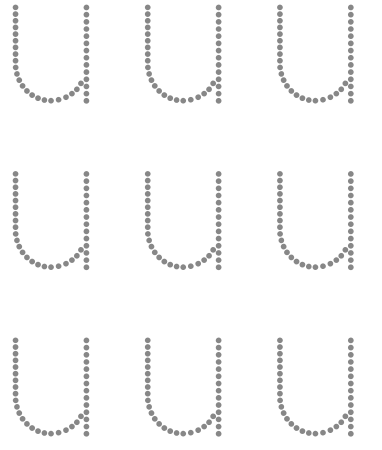

Yazma yönlerine dikkat ederek "U" harfini yazalım.

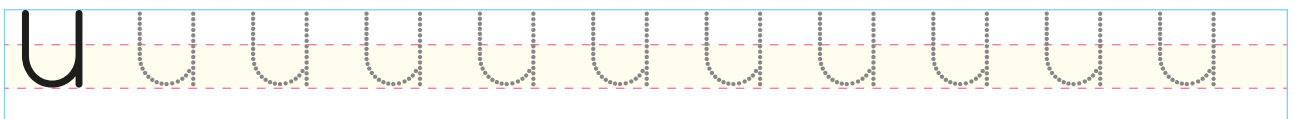
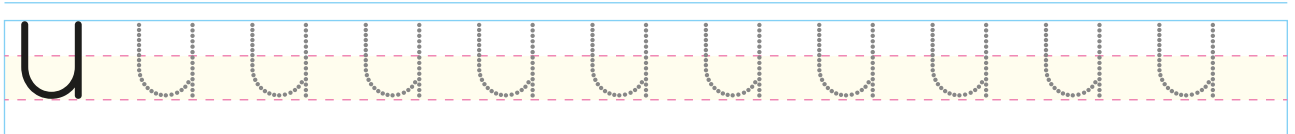
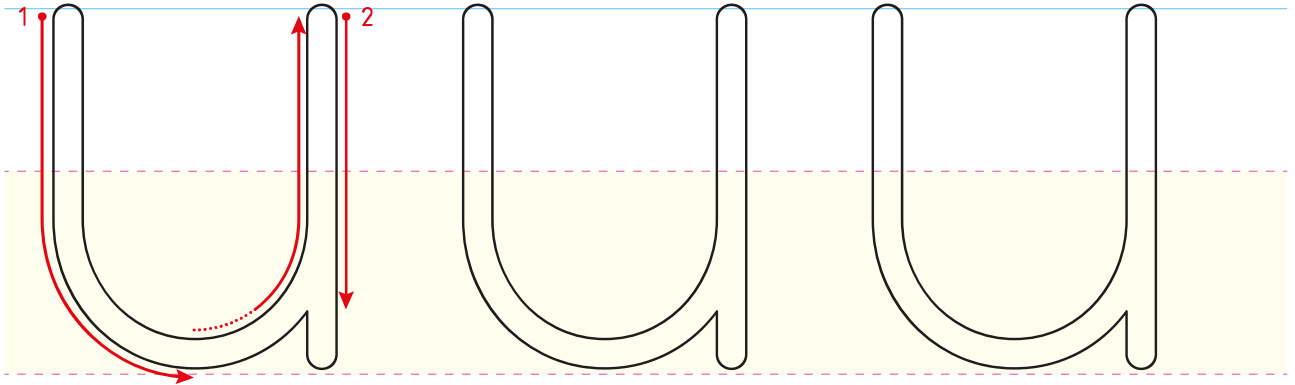



☞ "U" harfini yazalım.

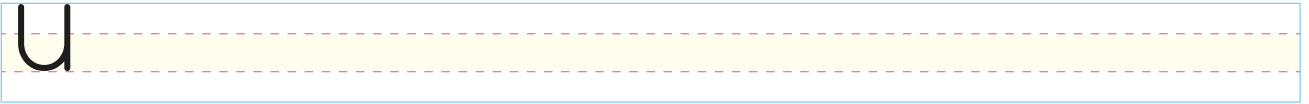
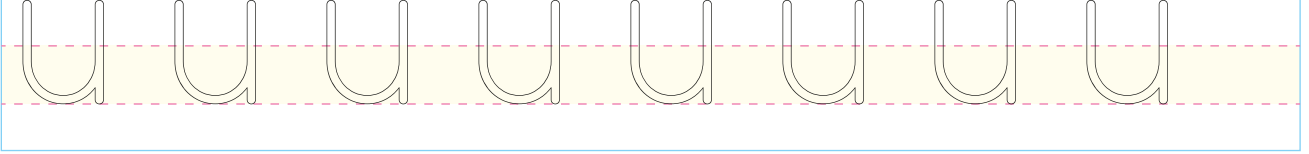



☞ Küçük "u" harfinin yazılış yönüne dikkat edelim. İçinden kalemimizle geçelim.

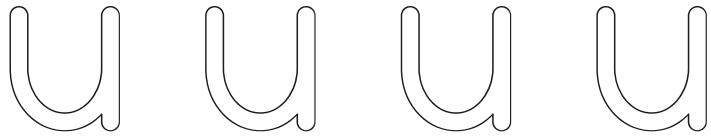
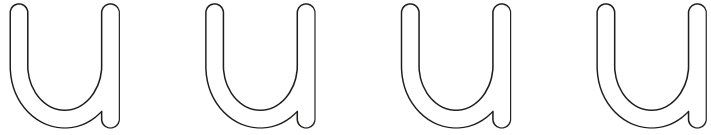
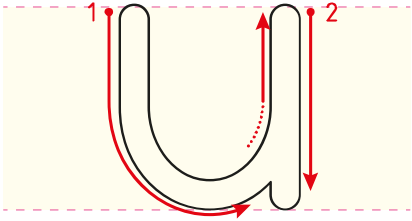

☞ "u" harfinin yazılı olduğu yıldızları boyayalım.



Yönergeleri uygulayalım.

• "u" harfini boyayalım.

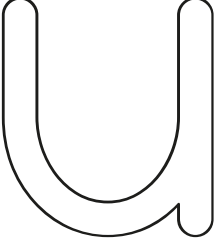

• "u" harflerini bulup yuvarlak içine alalım.

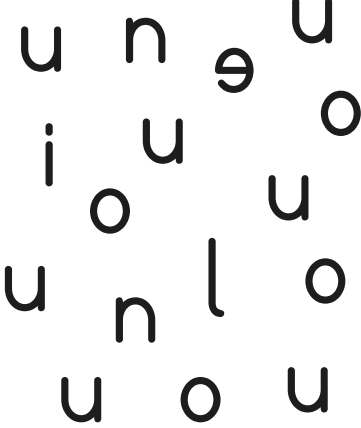

• Noktaları birleştirelim.

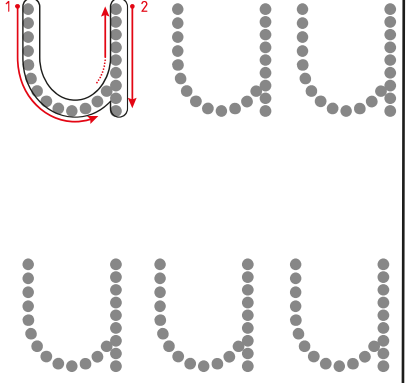

Yazma yönlerine dikkat ederek "u" harfini yazalım.

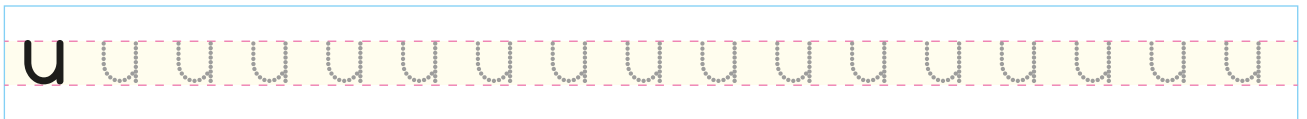
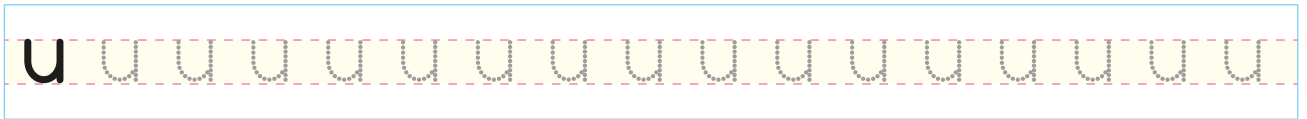
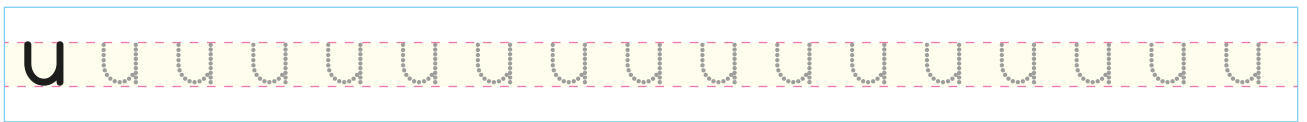
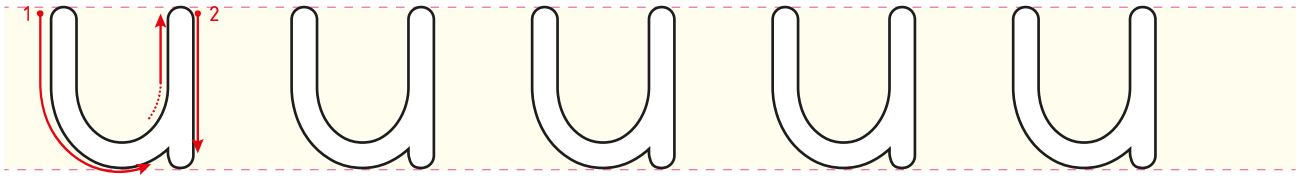



☞ "u" harfini yazalım.

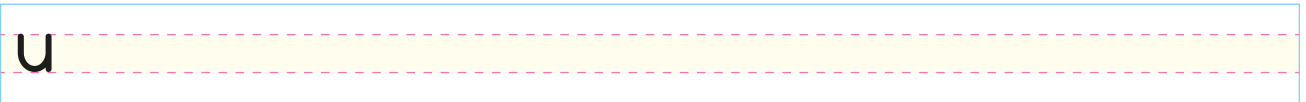
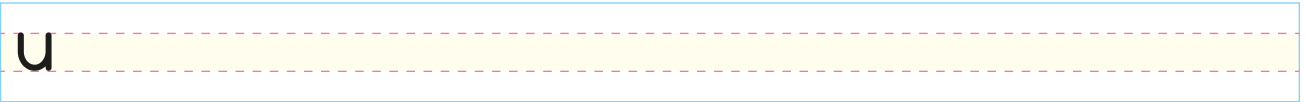
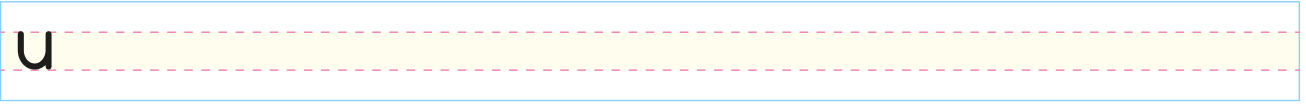
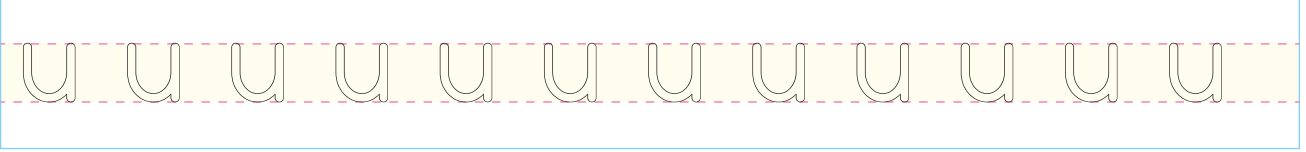

👉 "U" sesini takip ederek çocuğun uçurtmaya ulaşmasına yardımcı olalım.

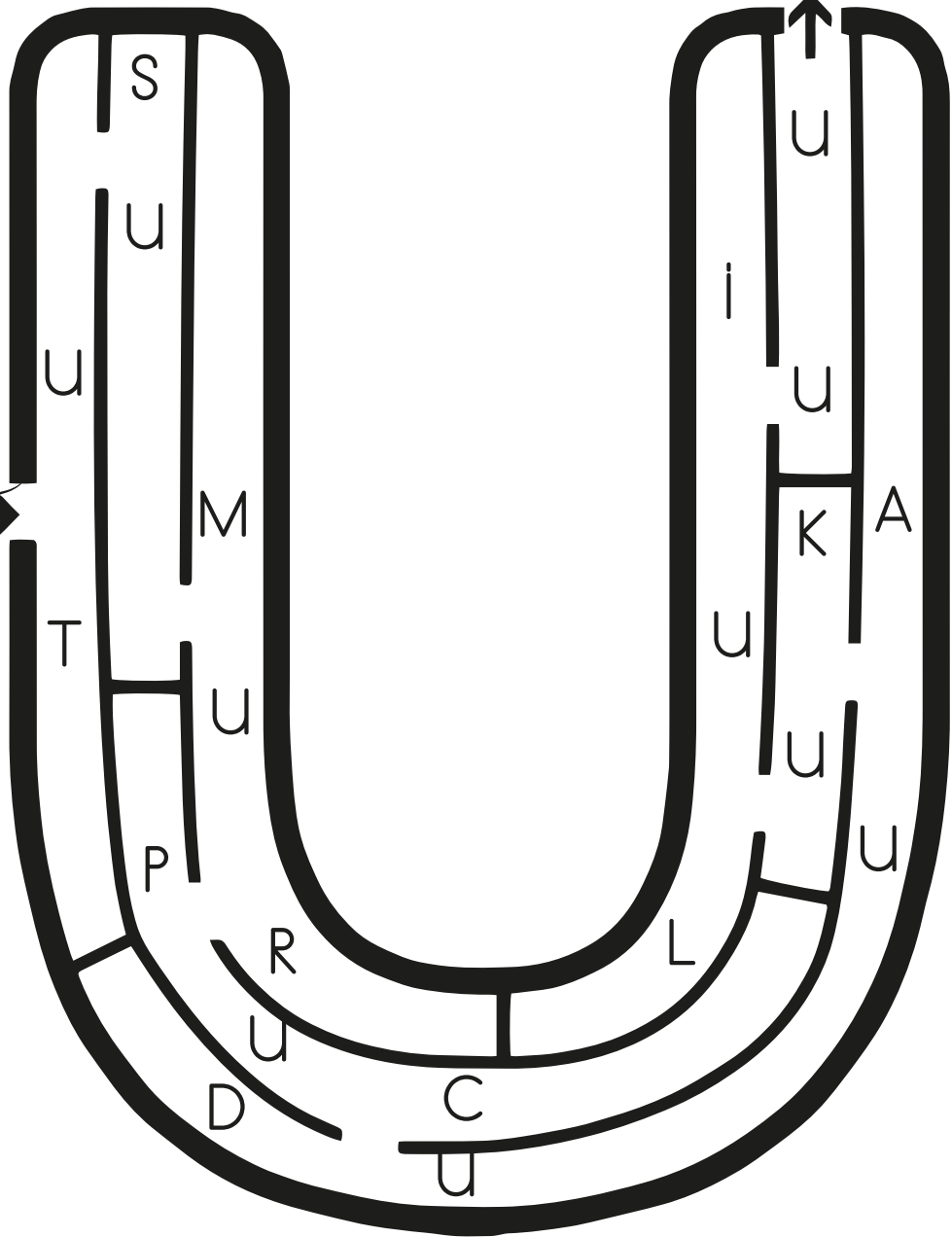
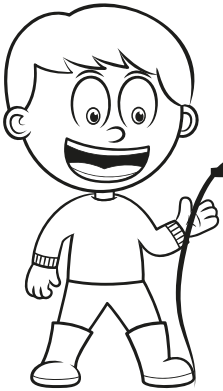
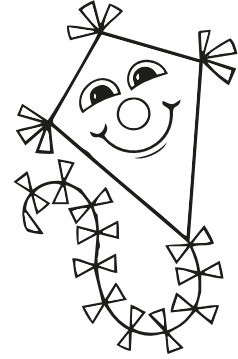



👉 Büyük "U" ve küçük "u" harfini yazalım.

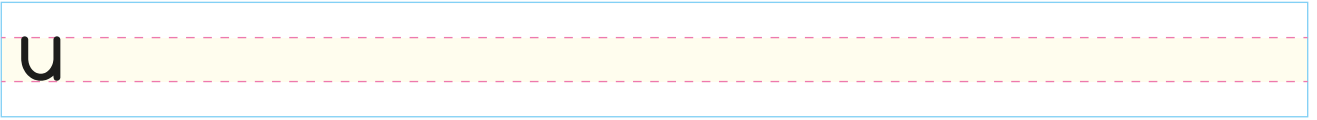
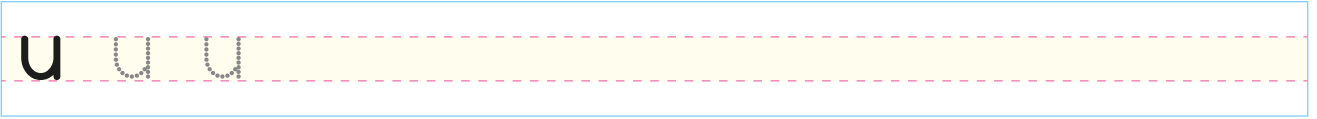
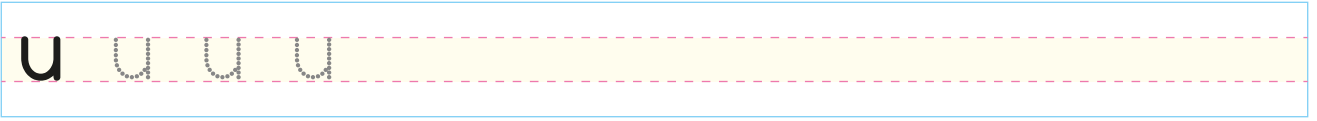
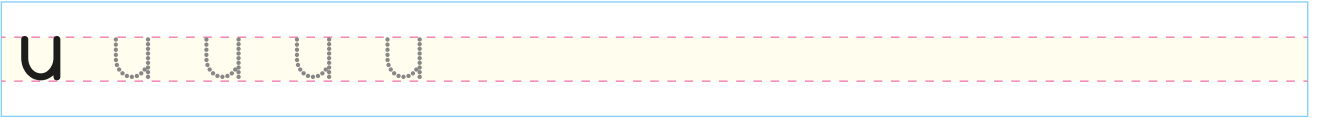
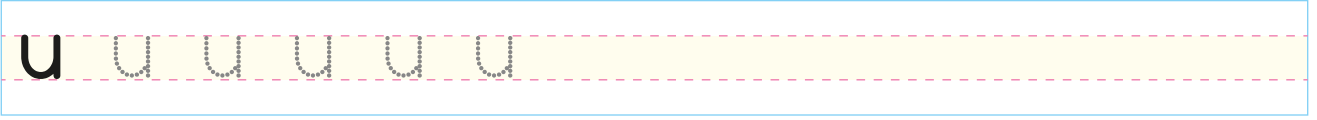
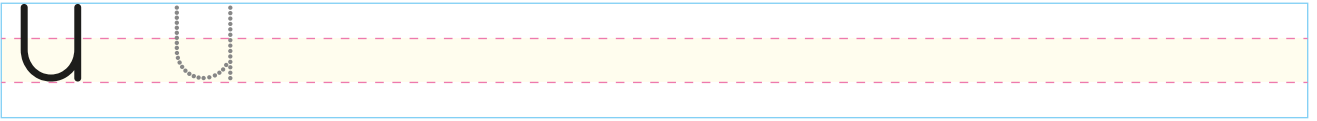
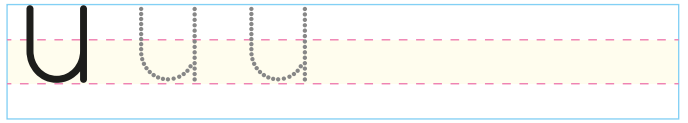
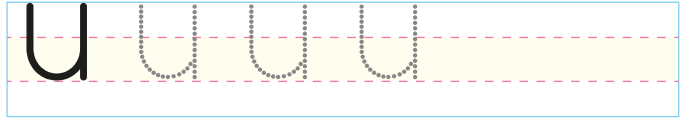
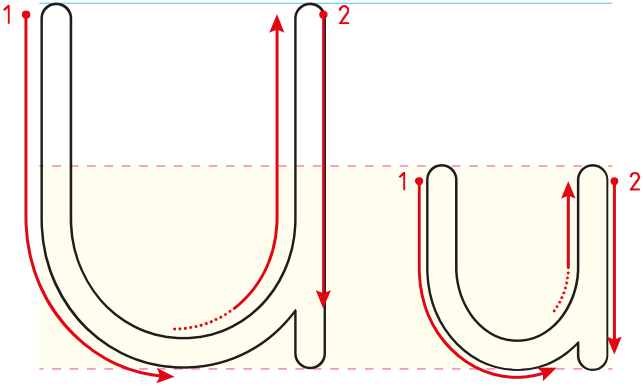



Okuyalım, yazalım.

u l ul ul

ul

ul

l u lu lu

lu

lu

u k uk uk

uk

uk

k u ku ku

ku

ku

lu k luk

on lu onlu

on luk onluk

ku l kul

o ku oku

o kul okul



Okuyalım, yazalım.

u n un un

un

un

n u nu nu

nu

nu

u m um um

um

um

m u mu mu

mu

mu

un lu unlu

un la unla

o nu onu

o nun onun

mu m mum

mu mu mumu



Okuyalım, yazalım.

ko ku koku koku koku

koku

kuk la kukla kukla kukla

kukla

ku lak kulak kulak kulak

kulak

Nu man Numan Numan Numan

Numan

Numan koku al.

Numan o kukla.



Okuyalım, yazalım.

u nu ko nu

o nu ku lu

ko nuk ko num

lo kum o luk

kol luk ka nun

Okuyalım, görseli boyayalım.

Numan, onu oku, anla.











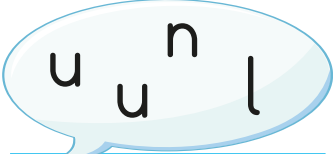
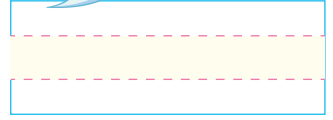

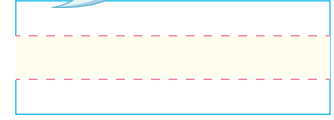
Okulu anla, onu oku.

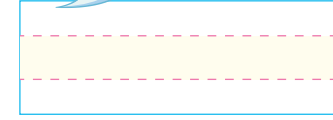
Onun kalemmini alma.

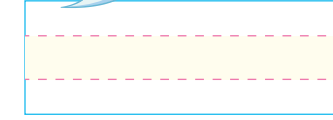

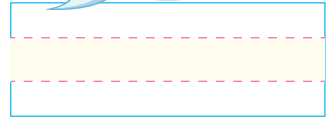

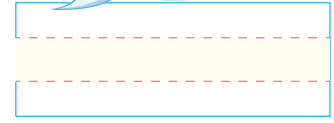
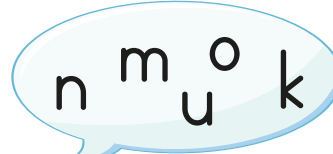
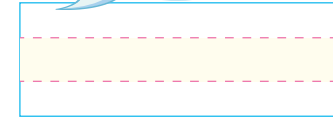





Okan'la konu anla.

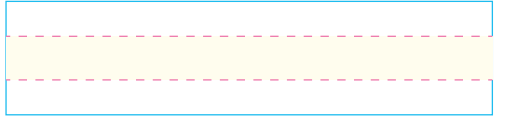

👉 Harflerle anlamlı kelimeler oluşturalım, yazalım.

👉 Heceleri eşleştirip kelimeler oluşturalım.

👉 Okuyalım, yazalım.

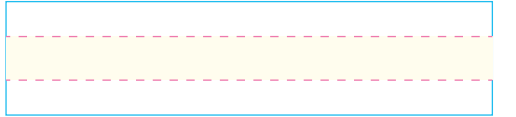
Lokumu al. 

Kolumu elleme. 

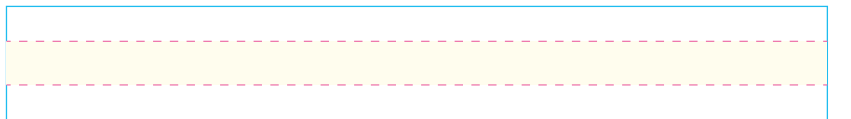
Emel kuleli. 



☞ Karışık kelimelerden cümleler oluşturup yazalım.

kukla

al

Emel'e

lokum

Ona

al

limonlu

kokulu

mum

al

Melek

Ela

Anne

mu

kilolu

kollu

iki

kukla

komik

onlu

al

Mualla

lokum

Okuyalım, diğer sayfaya yazalım.

EMİNE

Emine limon ile un al.

Anne unu ele.

Ele, ele unu ele.

Emine onu unla.

Unla Emine unla.

Anne un ile kekik ekle.

Ekle anne kekik ekle.

Anne kekik kokulu.

Anne ona kokulu kekik ekle.

Kokulu kekik ekili.

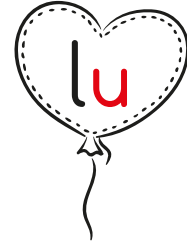



Blank writing area with a dashed line for tracing.

Blank writing area with a dashed line for tracing.

Blank writing area with a dashed line for tracing.

Blank writing area with a dashed line for tracing.

Blank writing area with a dashed line for tracing.

Blank writing area with a dashed line for tracing.

Blank writing area with a dashed line for tracing.

Blank writing area with a dashed line for tracing.

Blank writing area with a dashed line for tracing.

Blank writing area with a dashed line for tracing.

Blank writing area with a dashed line for tracing.

✎ Uçakların içinde yazılı olan kelimeleri okuyalım ve uygun yerlere yazalım.

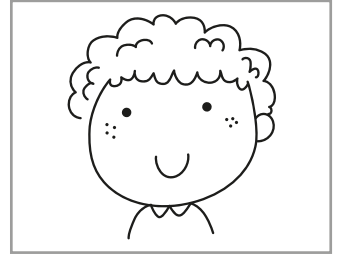
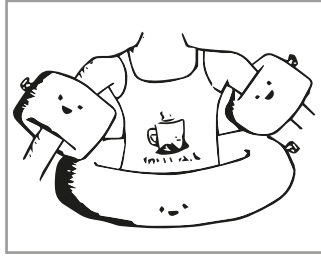
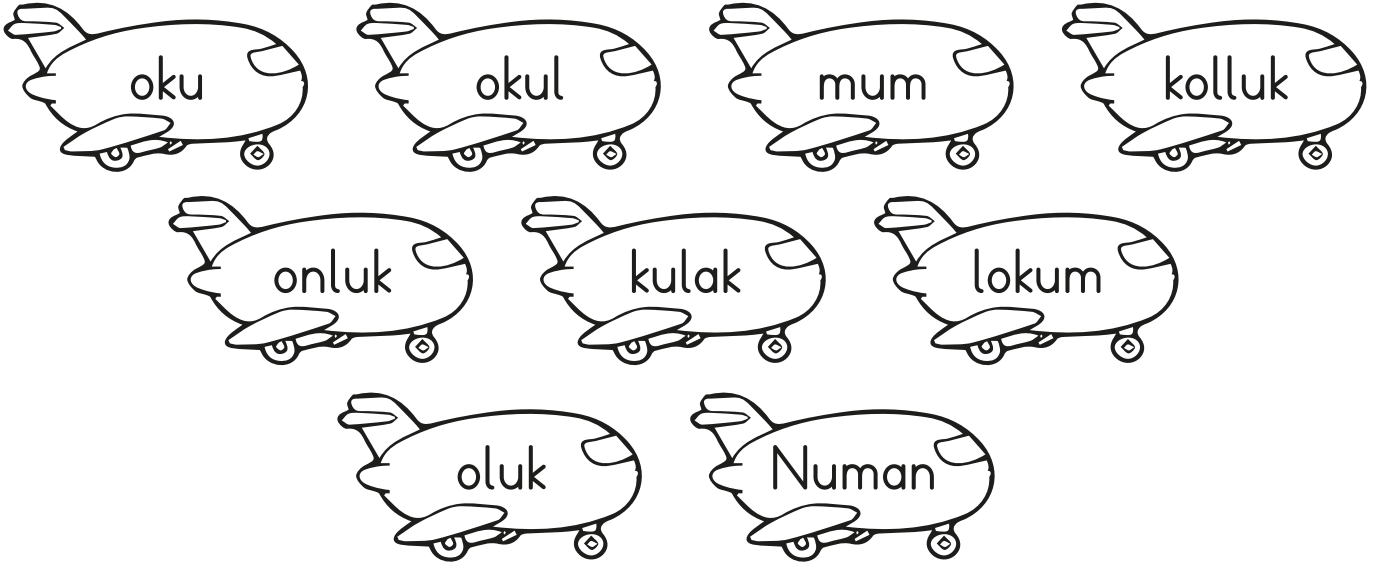

Blank space for writing the word 'gutter'.

Blank space for writing the word 'hot air balloon'.

Blank space for writing the word 'boy'.

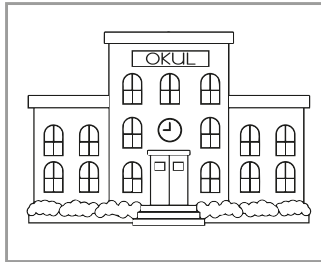

Blank space for writing the word 'candle'.

Blank space for writing the word 'school'.

Blank space for writing the word 'ear'.

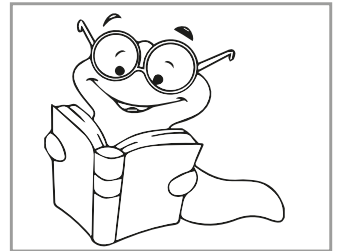
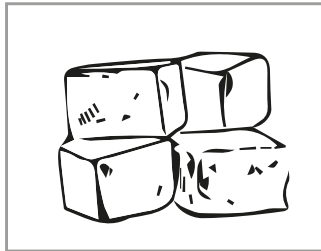
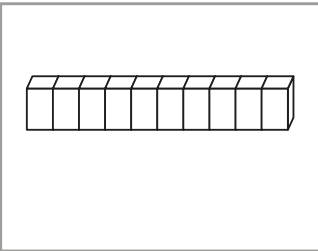

Blank space for writing the word 'blocks'.

Blank space for writing the word 'ice cubes'.

Blank space for writing the word 'reading'.



👉 8 rakamını yazalım.

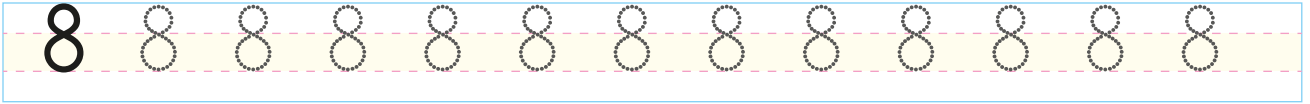
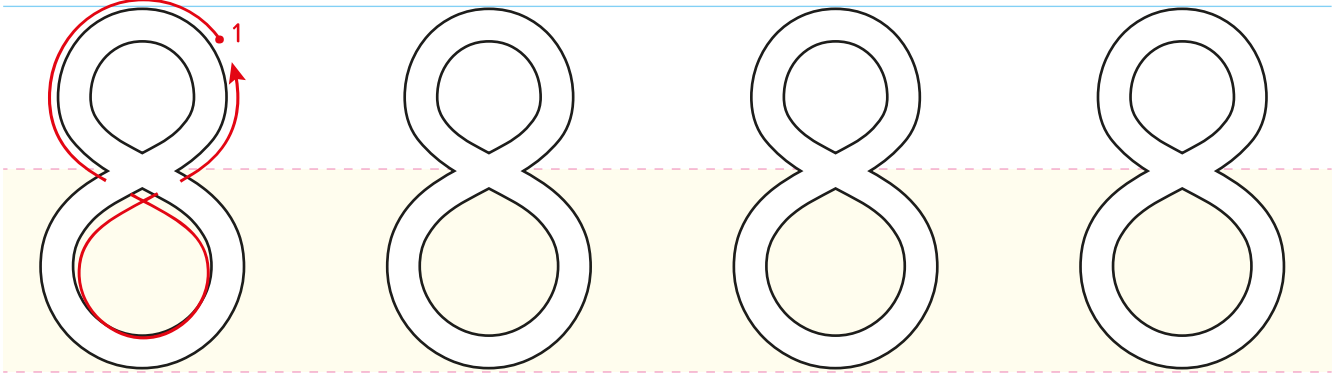

👉 Eksik cümleleri kelebeklerde verilen kelimelerle tamamlayıp bol bol okuyalım.

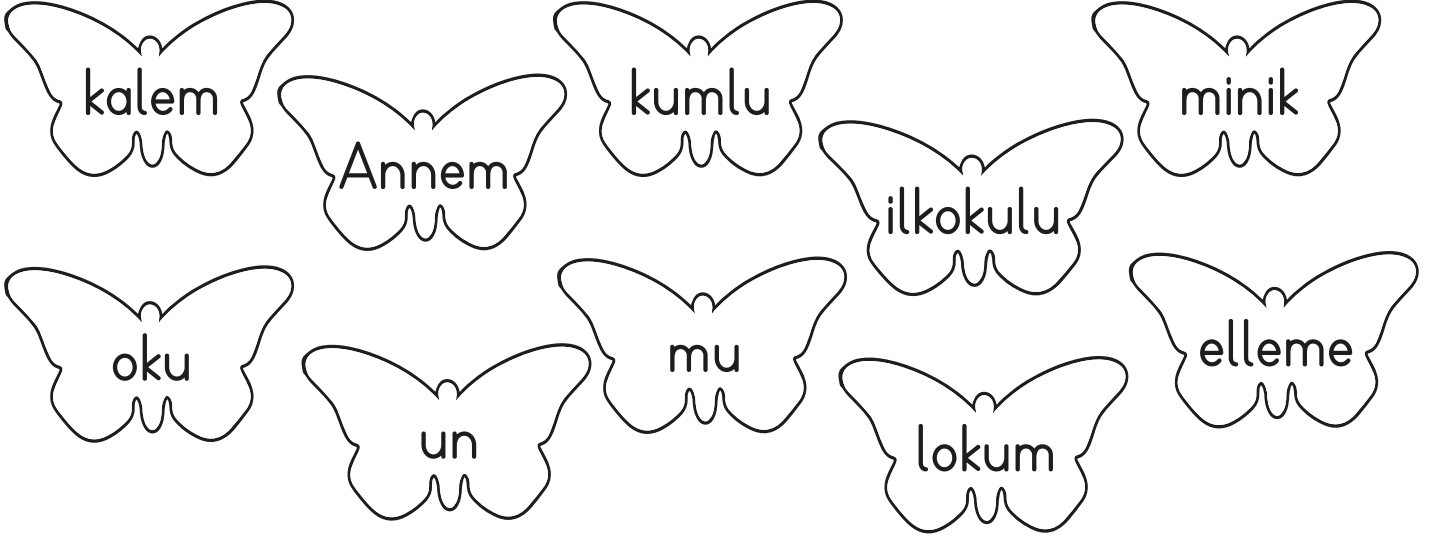

🎈 Numan mumu

🎈 Oku Okan

🎈 limonlu kek yedi.

🎈 Emine kek limonlu ?

🎈 Ela nineme alma.

🎈 On koli lila al.

🎈 Melek elek ile ele.

🎈 Kemal elin ile elleme.

🎈 O okul Ali'nin

🎈 Lale keki yedi.

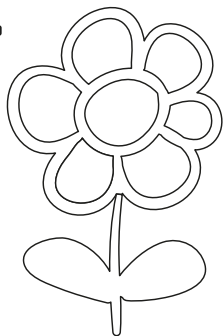

Verilen metni 5 kere okuyalım. Her okumanın ardından bir yıldız boyayalım. Boş bırakılan yere metni güzelce yazalım.

OKUL

Ali o okul.

Ali o okul, ilkokul.

Okulum, ilkokulum.

Oku Ali oku.

Makale oku.



Blank writing area with a dashed line for tracing.

Blank writing area with a dashed line for tracing.

Blank writing area with a dashed line for tracing.

Blank writing area with a dashed line for tracing.

Blank writing area with a dashed line for tracing.

Blank writing area with a dashed line for tracing.

Verilen metni 5 kere okuyalım. Her okumanın ardından bir yıldız boyayalım. Boş bırakılan yere metni güzelce yazalım.

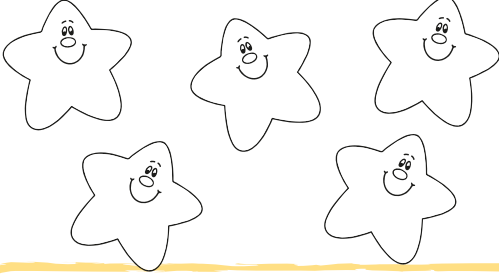

MUM

Melek o mum.

Mumu elleme.

Mumu eline alma.

Mumu mumluk ile kullan.

Blank writing area with a dashed line for tracing.

Blank writing area with a dashed line for tracing.

Blank writing area with a dashed line for tracing.

Blank writing area with a dashed line for tracing.

Blank writing area with a dashed line for tracing.



☞ Verilen metni 5 kere okuyalım. Her okumanın ardından bir yıldız boyayalım. Boş bırakılan yere metni güzelce yazalım.

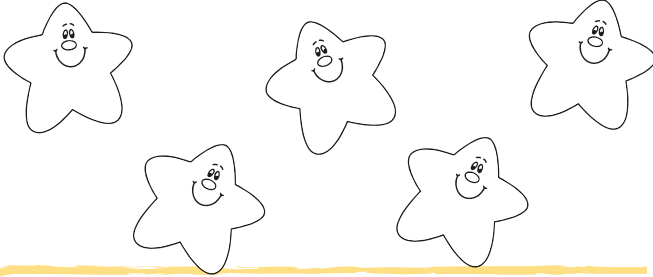

LOKUM

Kemal elin kumlu.
Kumlu eline lokum alma.
Anne ona lokum al.
Naneli lokum al.

Blank writing line with a dashed red line for tracing.

Blank writing line with a dashed red line for tracing.

Blank writing line with a dashed red line for tracing.

Blank writing line with a dashed red line for tracing.

Blank writing line with a dashed red line for tracing.

☞ Verilen metni 5 kere okuyalım. Her okumanın ardından bir yıldız boyayalım. Boş bırakılan yere metni güzelce yazalım.

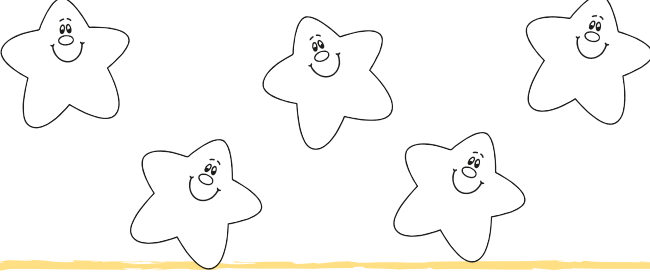

KUKLA

Numan o kukla.
O komik 1 kukla.
Kuklam minik.
Kukla ile kol kola olma.



Blank writing area with a dashed line for the first row.

Blank writing area with a dashed line for the first row.

Blank writing area with a dashed line for the first row.

Blank writing area with a dashed line for the first row.

Blank writing area with a dashed line for the first row.



☞ Bulutlardaki heceler ile balıklardaki eksik yazılmış kelimeleri tamamlayalım.

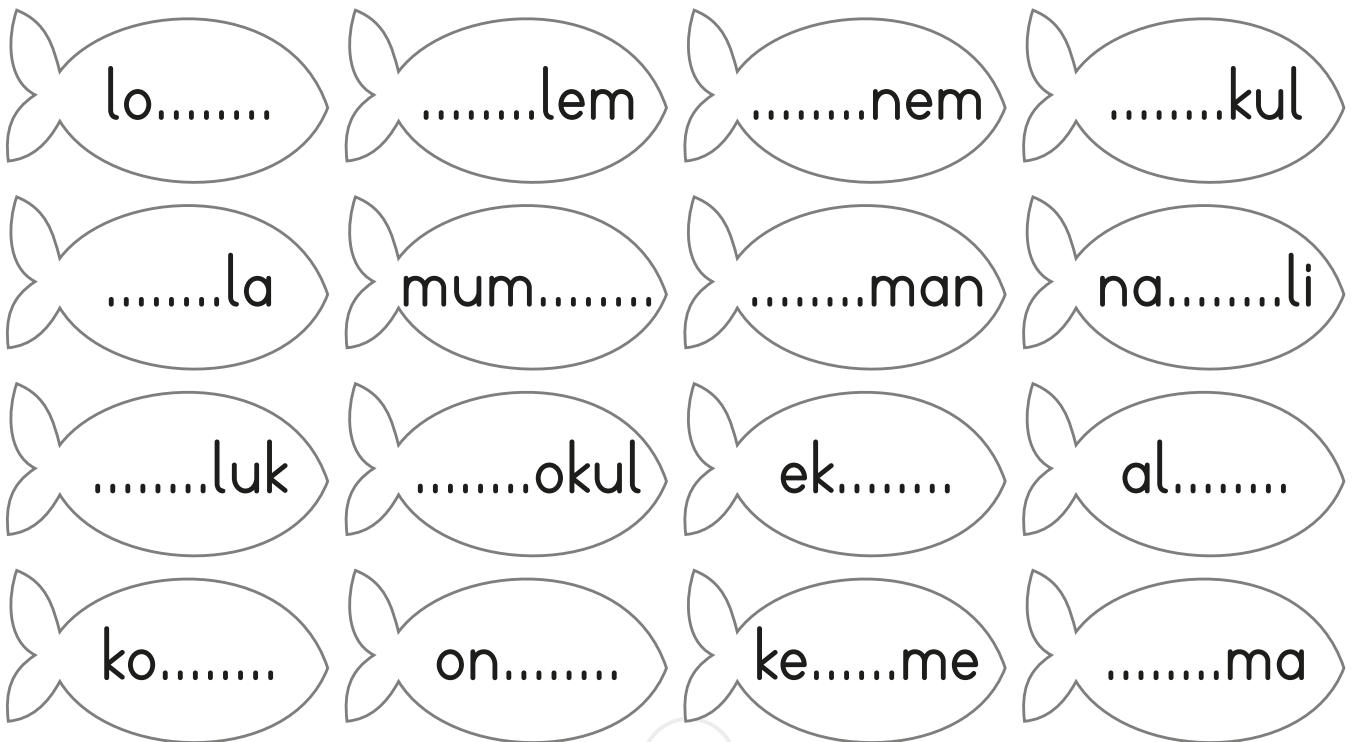
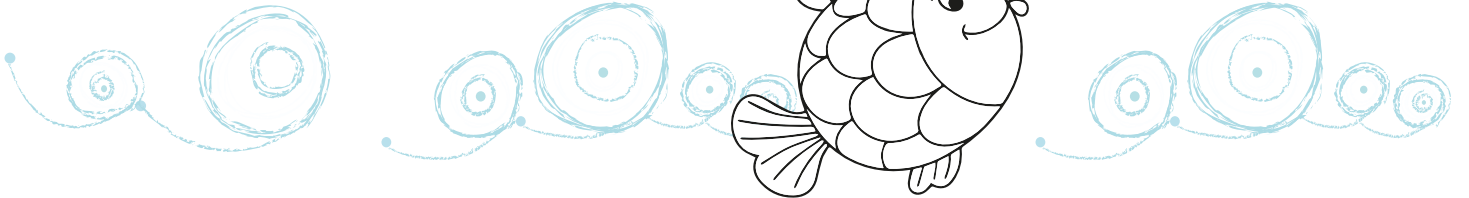

👉 Adında "t" sesi bulunan varlıkları boyayalım.

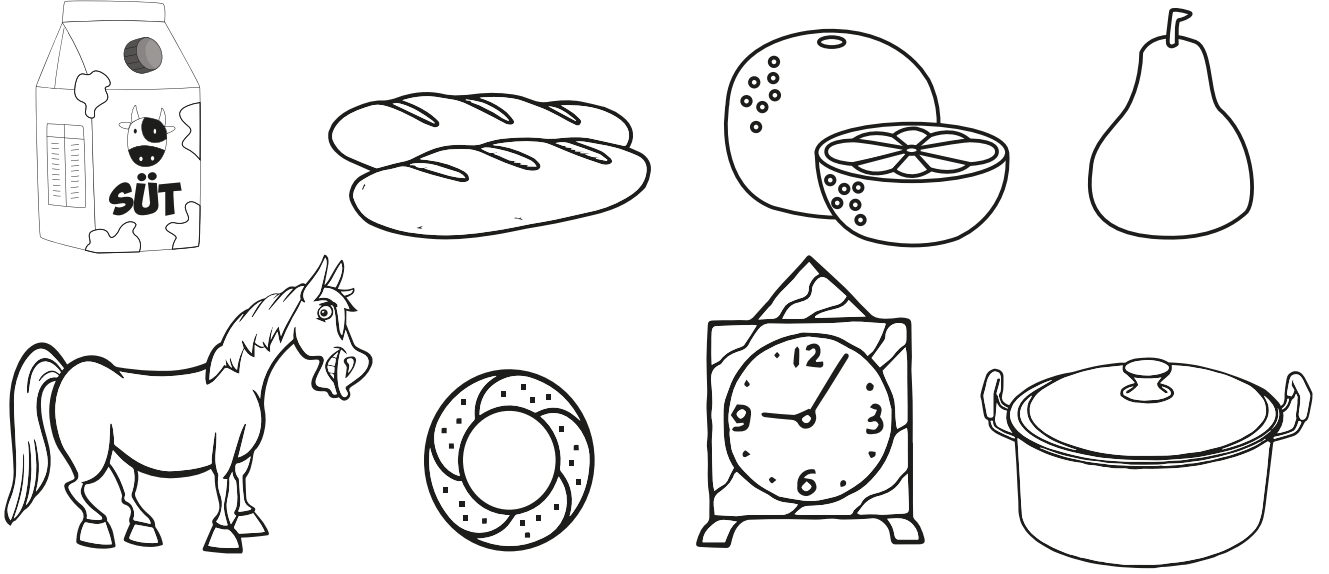

👉 "t" sesi ile başlayan varlıkları işaretleyelim.



👉 Büyük "T" harfinin yazılış yönüne dikkat edelim. İçinden kalemimizle geçelim.

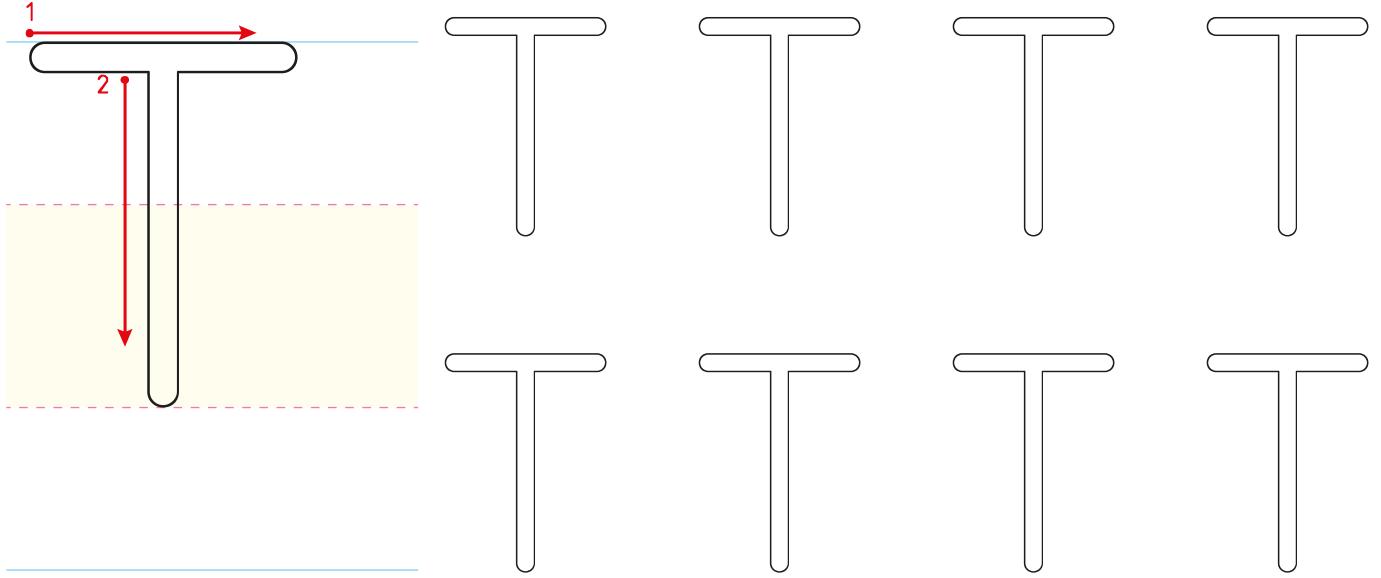

👉 "T" harfinin yazılı olduğu balonları boyayalım.

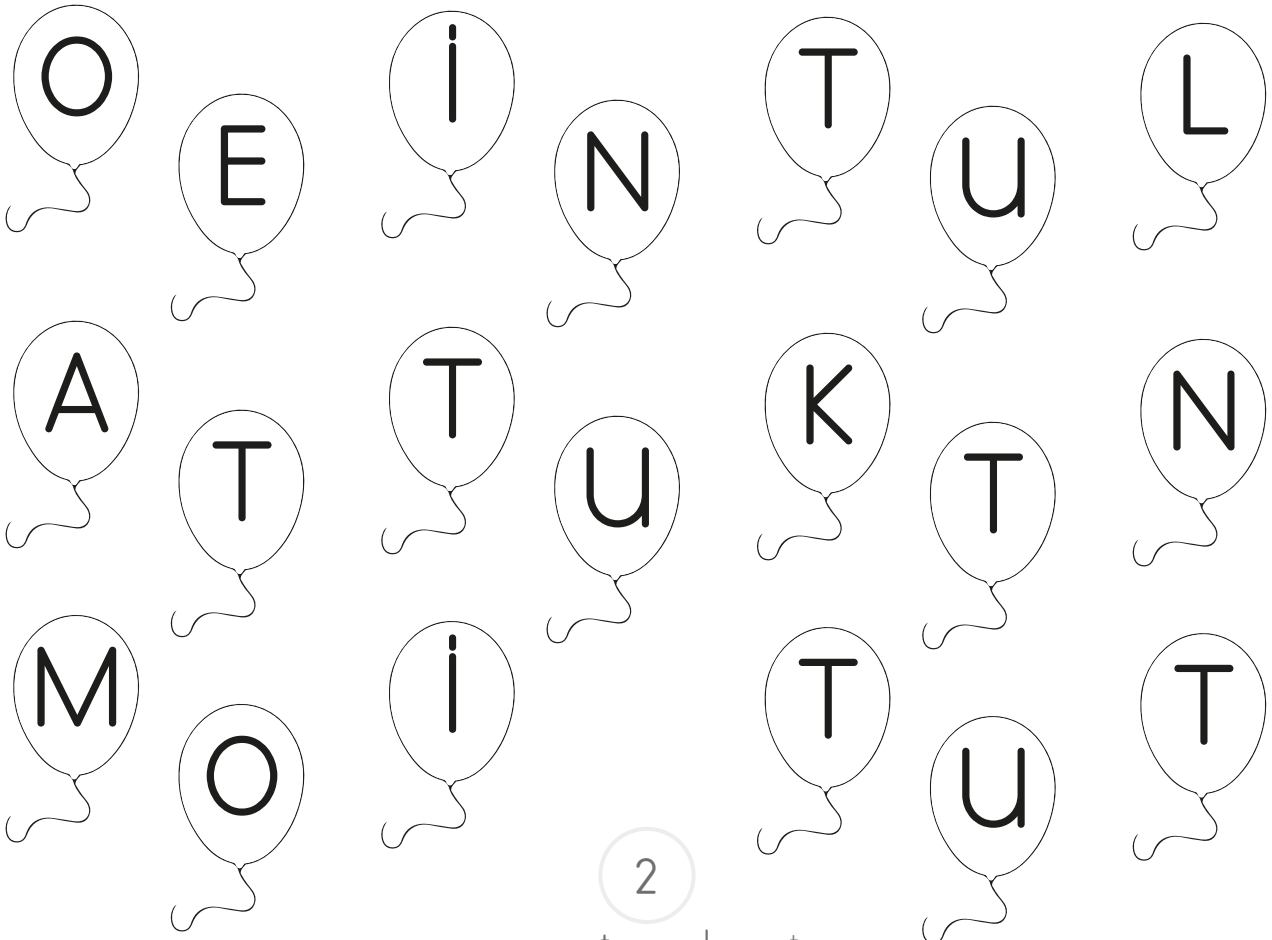

Yönergeleri uygulayalım.

• "T" harfini boyayalım.

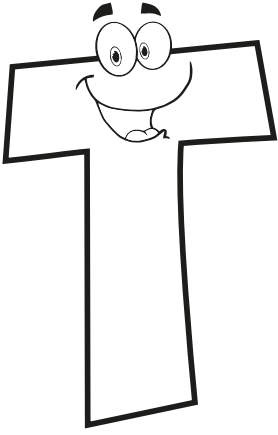

• "T" harflerini bulup yuvarlak içine alalım.

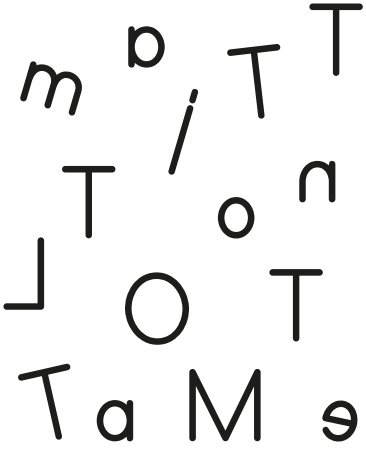

• Noktaları birleştirelim.

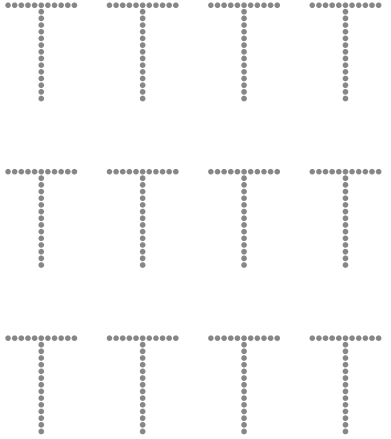

Yazma yönlerine dikkat ederek "T" harfini yazalım.

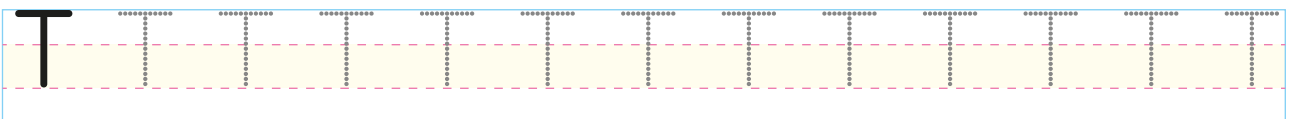
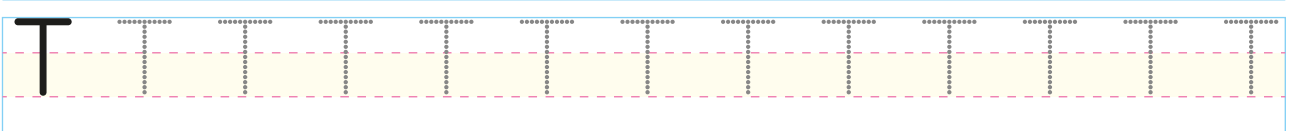
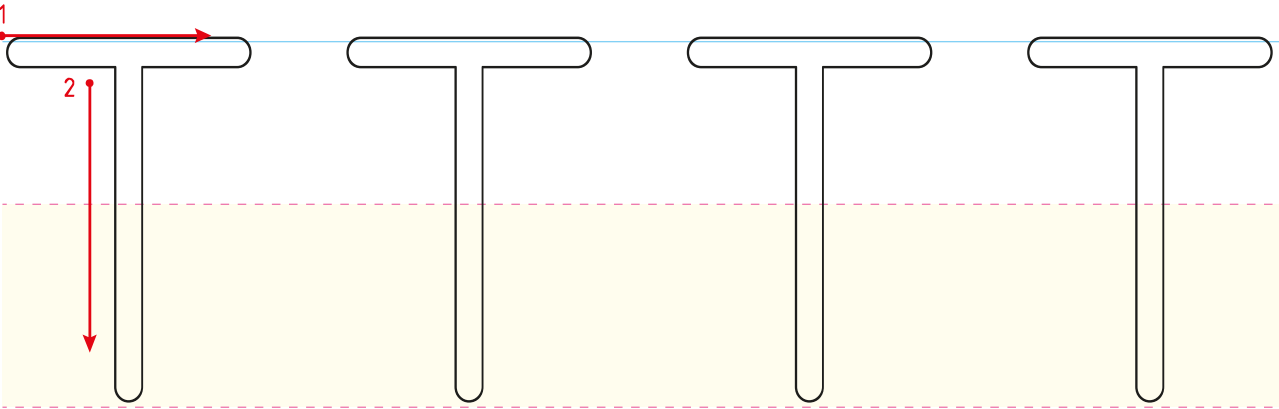



☞ "T" harfini yazalım.

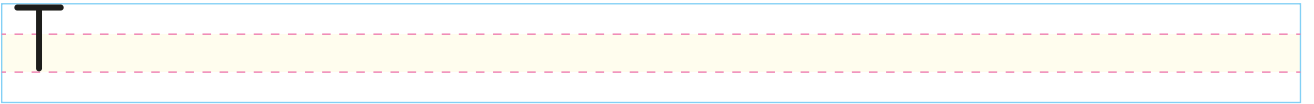
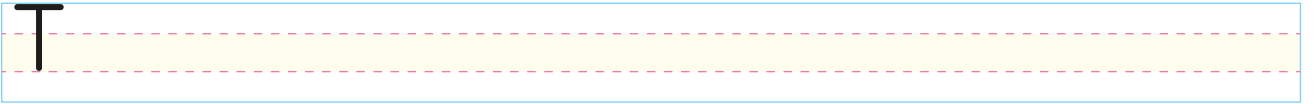
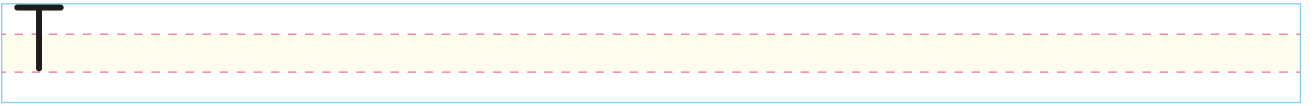
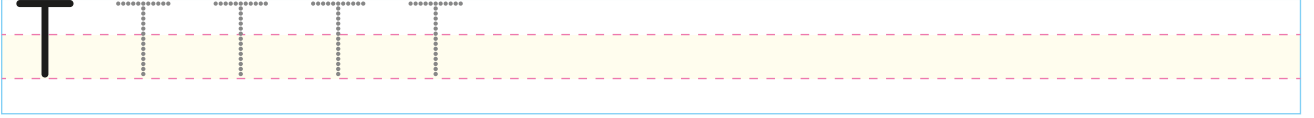
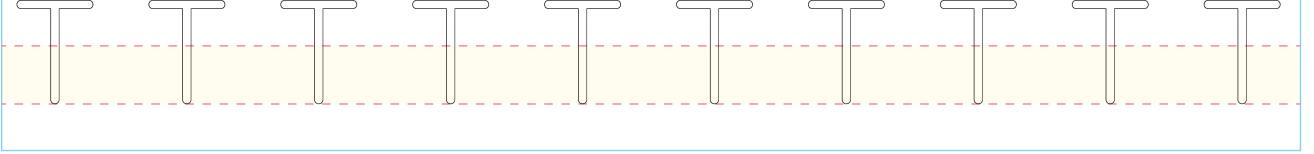



☞ Küçük "t" harfinin yazılış yönüne dikkat edelim. İçinden kalemimizle geçelim.

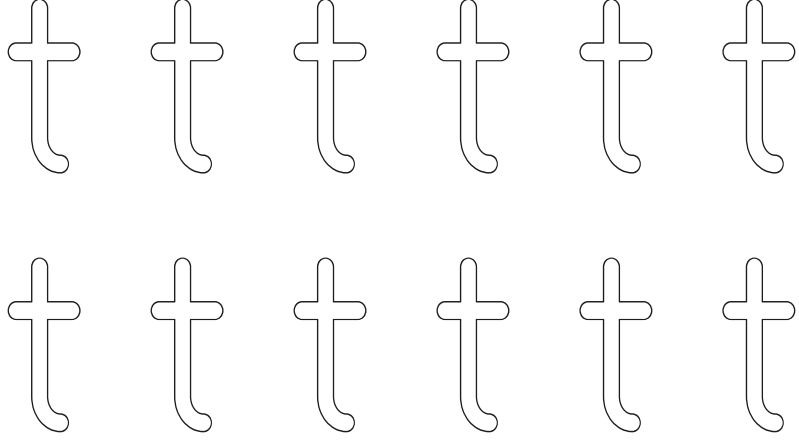
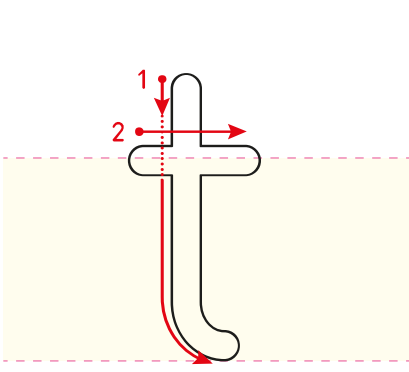

☞ "t" harfinin yazılı olduğu yıldızları boyayalım.



Yönergeleri uygulayalım.

• "t" harfini boyayalım.

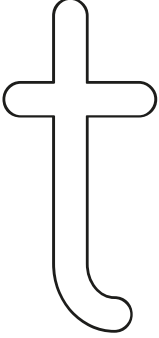

• "t" harflerini bulup yuvarlak içine alalım.

o t k t
i j i t e
t m l o
t t u

• Noktaları birleştirelim.

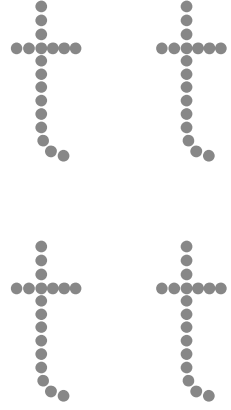
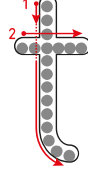

Yazma yönlerine dikkat ederek "t" harfini yazalım.

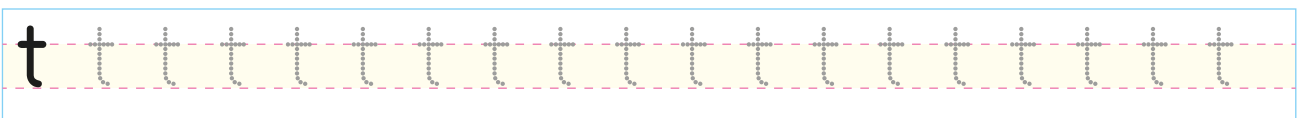
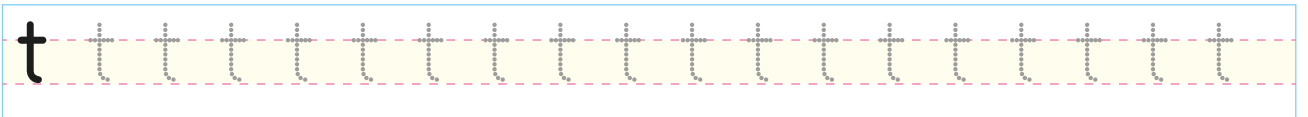
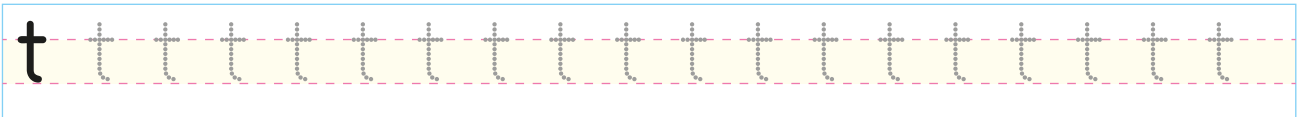
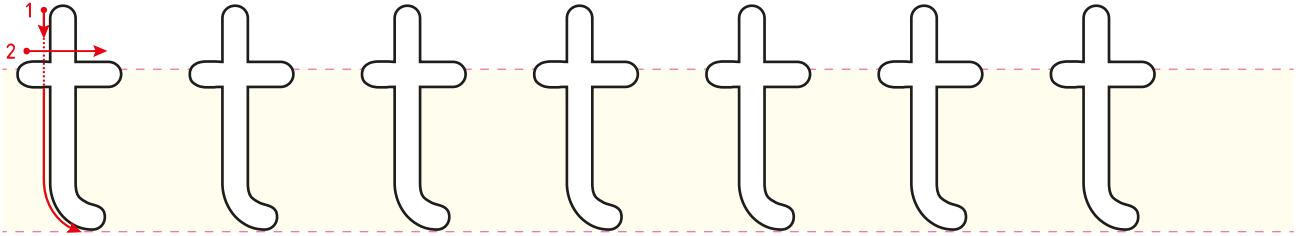



☞ "t" harfini yazalım.

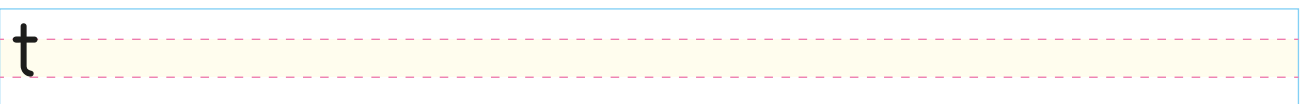
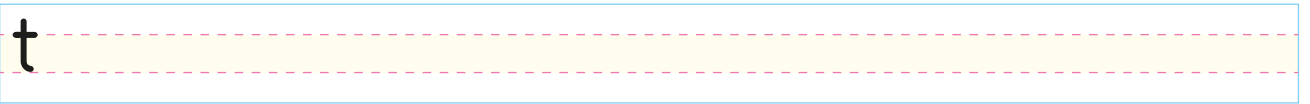
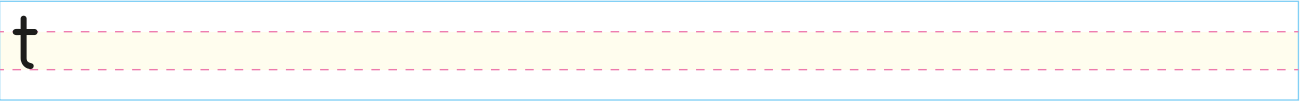
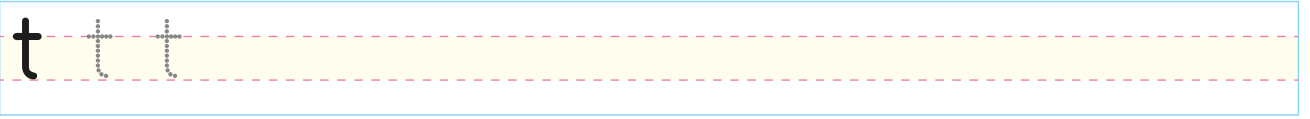
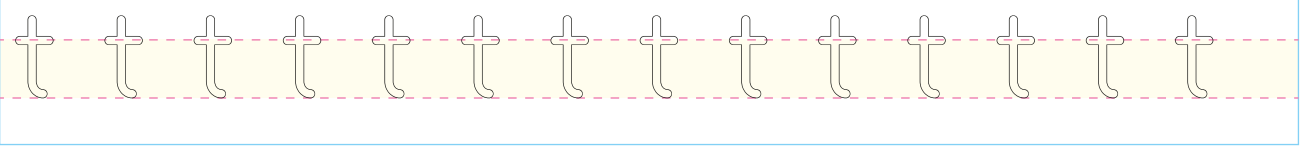

Boyayalım.

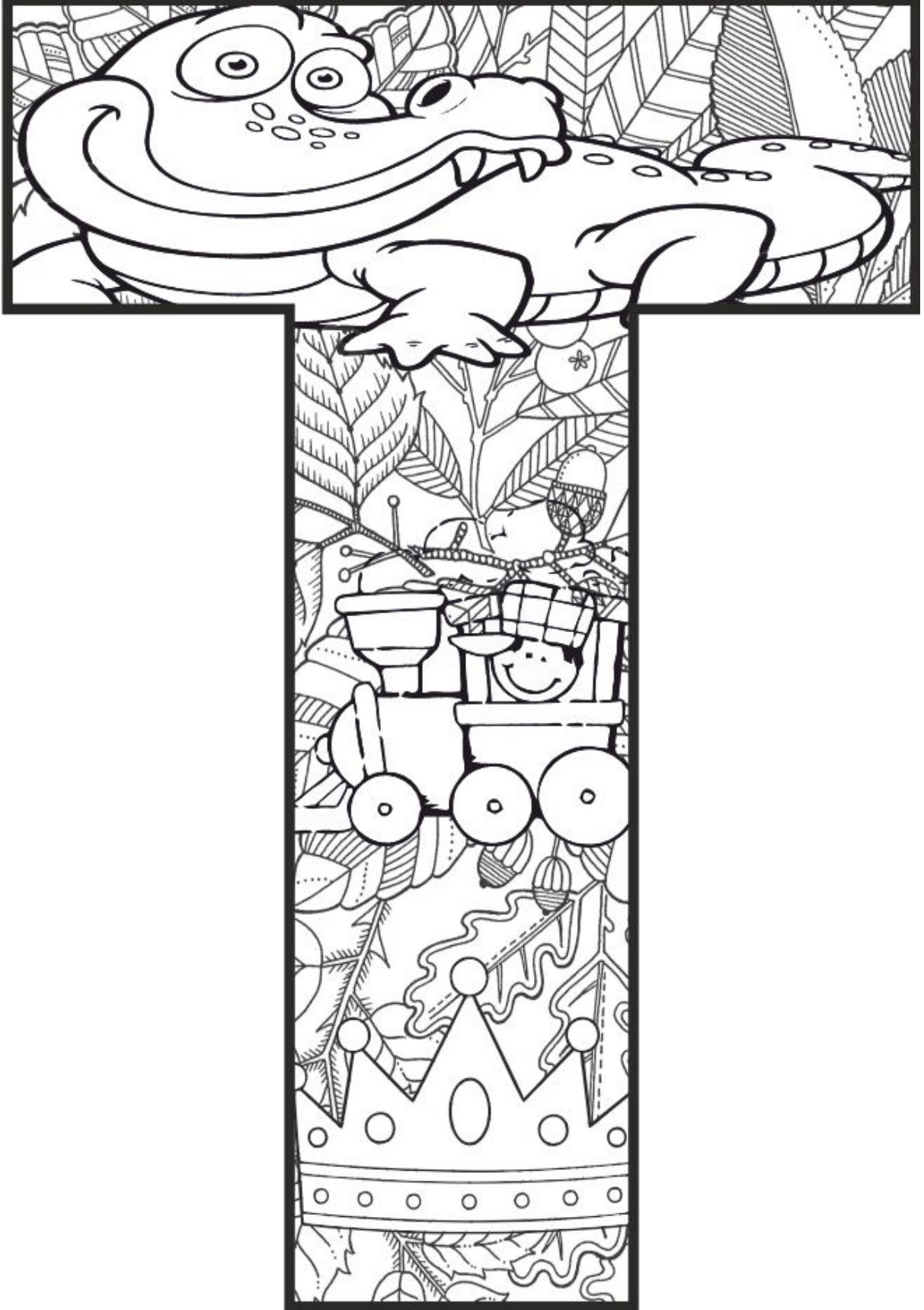



👉 Büyük "T" ve küçük "t" harfini yazalım.

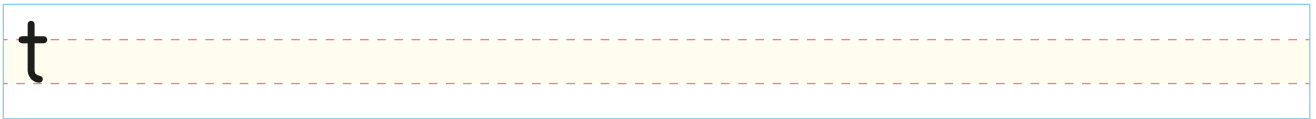
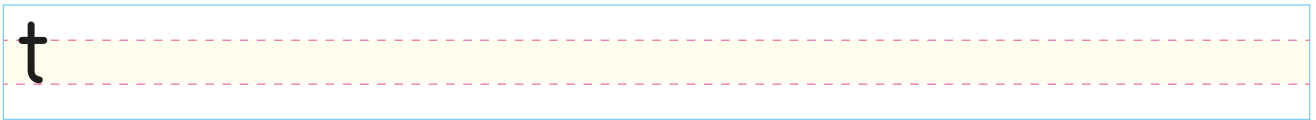
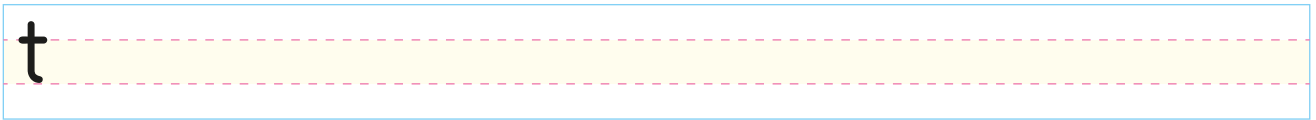
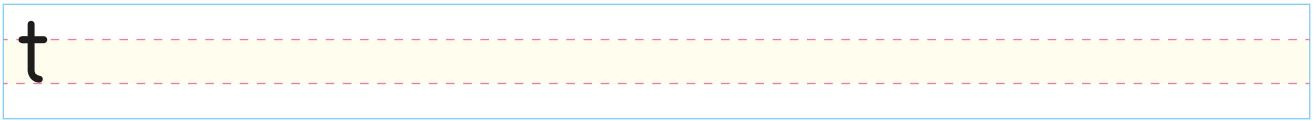
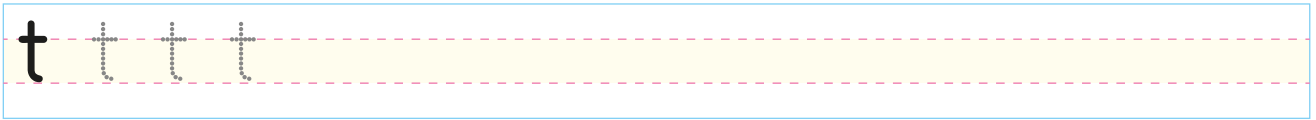
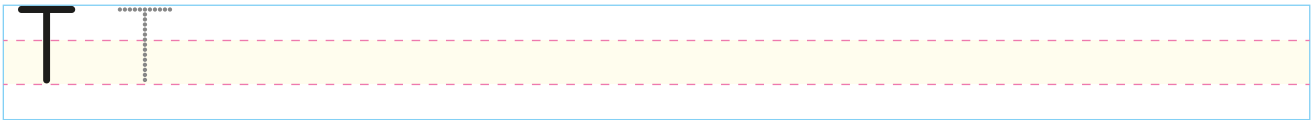
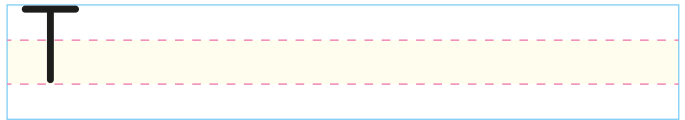
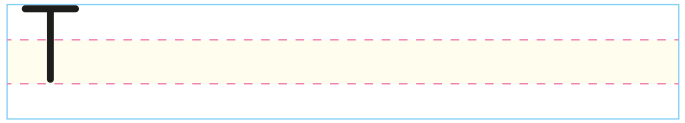
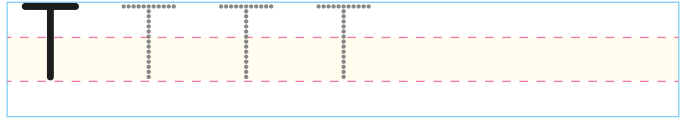
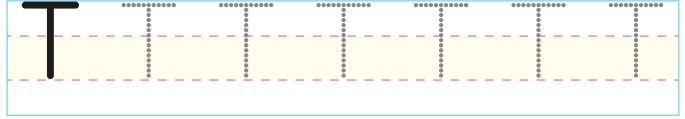
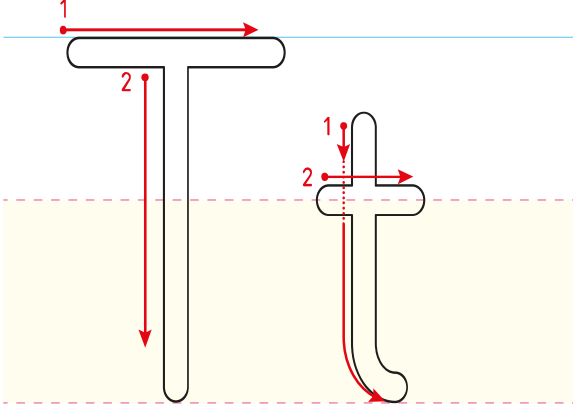



Okuyalım, yazalım.

e t et et

et

et

t e te te

te

te

a t at at

at

at

t a ta ta

ta

ta

i t it it

it

it

t i ti ti

ti

ti

et li

at ma

it ti

te kil

ta til

ti ki



Okuyalım, yazalım.

o t ot ot

ot

ot

t o to to

to

to

u t ut ut

ut

ut

t u tu tu

tu

tu

ot la otl

Ut ku Utku

to ka toka

Tu na Tuna

U mut Umut

Mut lu Mutlu



Okuyalım, yazalım.

tak

lit

taklit

taklit

taklit

Te

kin

Tekin

Tekin

Tekin

tu

lum

tulum

tulum

tulum

Tekin taklit et.

Utku tulum al.



Okuyalım, yazalım.

i	nat		at	la	
Ta	lat		an	lat	
at	let		kut	lu	
Al	tan		Mel	tem	
O	nat		tut	tu	

Okuyalım, görseli boyayalım.

Utku teli tuttu.
Talat ona anlat.
Meltem inat etme.
Alttan ata atla.

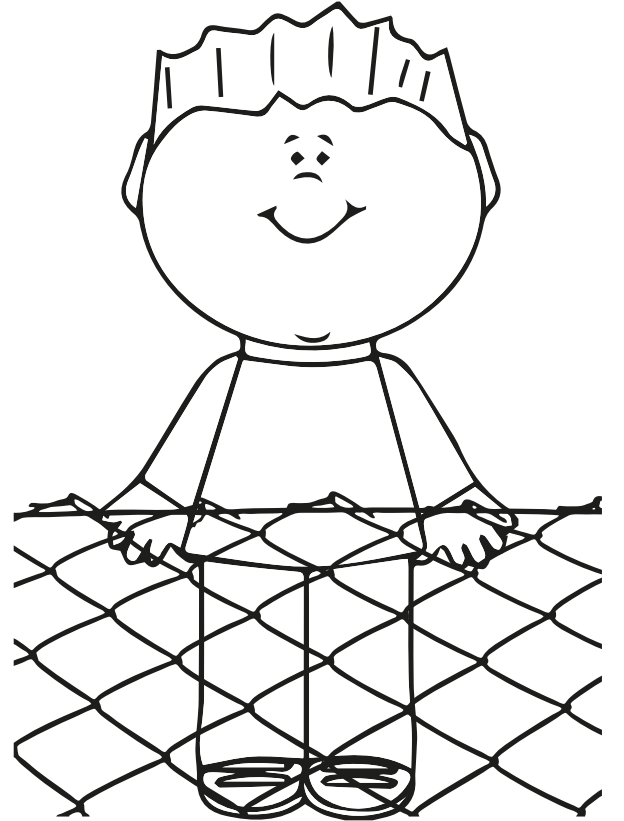

👉 Harflerle anlamlı kelimeler oluşturalım, yazalım.

t n O a

a A t

l e m t
M e t

T a n u

k t U u

i k T e n

n M t e i

t u m U

👉 Heceleri eşleştirip kelimeler oluşturalım.

A

ne

kan

ko

mu

tan

te

ta

ke

👉 Okuyalım, yazalım.

Onat inek otlat.

Tekin keki tat.

Nimet umut ol.



Verilen metni 5 kere okuyalım. Her okumanın ardından bir yıldız boyayalım. Boş bırakılan yere metni güzelce yazalım.

TUNA



Tuna al.

Tuna ekmek al.



Tuna iki tane ekmek al.

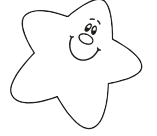

Tuna iki tane etli ekmek al.

Tuna anneme iki tane etli ekmek al.

Tuna anneme iki tane etli ekmek ile kola al.

Tuna anneme iki tane etli ekmek al.

Tuna iki tane etli ekmek al.

Tuna iki tane ekmek al.

Tuna ekmek al.

Tuna al.

Tuna



Handwriting practice line with a dashed middle line and a yellow shaded area.

Handwriting practice line with a dashed middle line and a yellow shaded area.

Handwriting practice line with a dashed middle line and a yellow shaded area.

Handwriting practice line with a dashed middle line and a yellow shaded area.

Handwriting practice line with a dashed middle line and a yellow shaded area.

Handwriting practice line with a dashed middle line and a yellow shaded area.

Handwriting practice line with a dashed middle line and a yellow shaded area.

Handwriting practice line with a dashed middle line and a yellow shaded area.

Handwriting practice line with a dashed middle line and a yellow shaded area.

Handwriting practice line with a dashed middle line and a yellow shaded area.

Handwriting practice line with a dashed middle line and a yellow shaded area.

Handwriting practice line with a dashed middle line and a yellow shaded area.

Handwriting practice line with a dashed middle line and a yellow shaded area.

Handwriting practice line with a dashed middle line and a yellow shaded area.

Verilen metni 5 kere okuyalım. Her okumanın ardından bir yıldız boyayalım.

MUTLU OL

Tekin mutlu ol.

Annen ile mutlu ol.

Ninen ile mutlu ol.

Ailen ile mutlu ol.



TATİL

Umut o otel kaliteli.

Annen ile el ele tatile.

Umut otelin kantinine in.

Altı kutu kola al.



Verilen metni 5 kere okuyalım. Her okumanın ardından bir yıldız boyayalım.

MONT

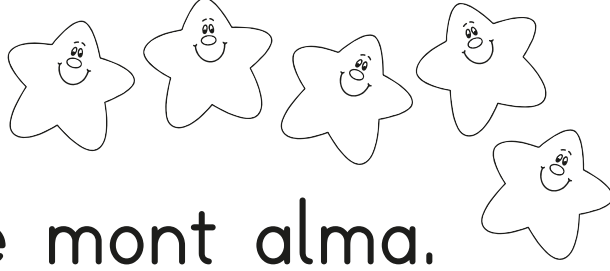

Utku iki tane mont alma.

Utku kaliteli mont al.

Montunu katlama.

Montunu ütüle.



ETEK



Meltem etek al.

Ama kaliteli al.

Meltem tutumlu ol.

İki etek alma.



☞ Kamyonların üzerindeki yazıları okuyalım. Görsellerin altına uygun olanı yazalım.

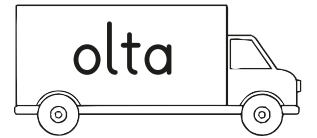
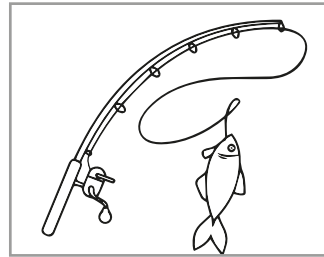
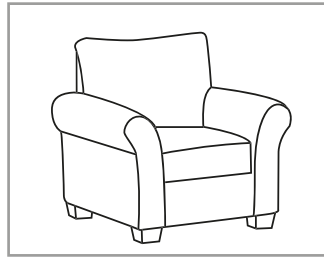
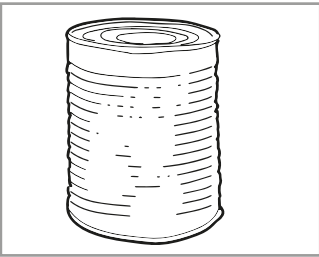
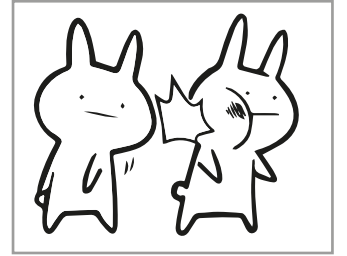
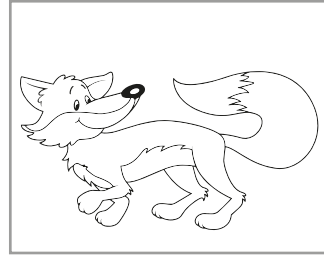
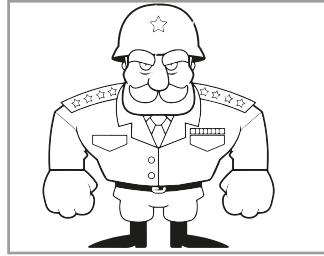
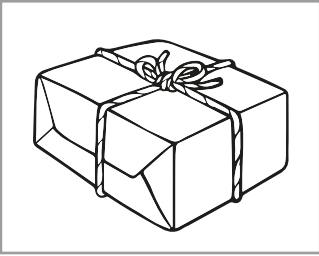
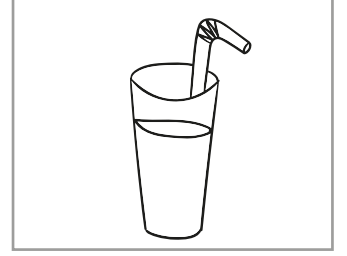
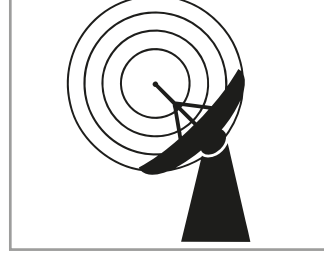



👉 9 rakamını yazalım.

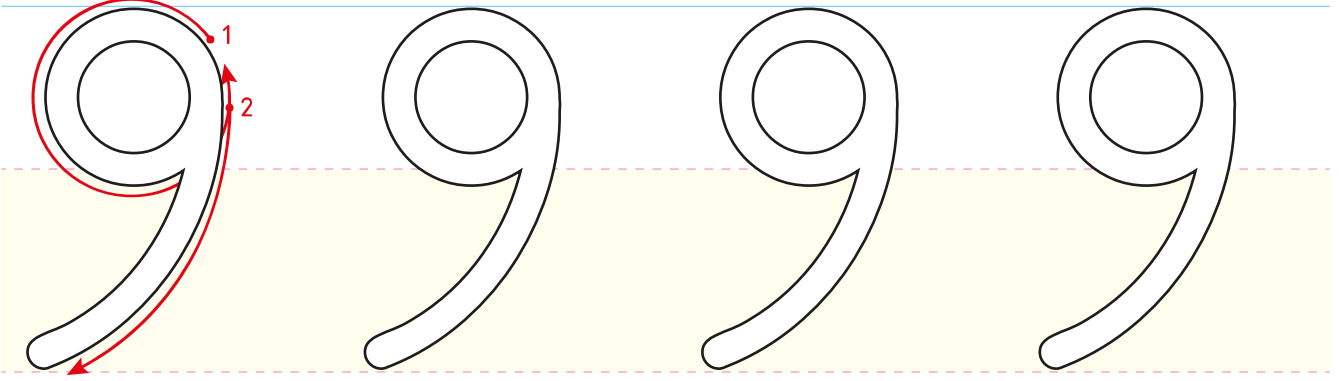

9 9 9 9 9 9 9 9 9 9 9 9 9

9 9 9 9 9

9

9

9

9

9

9

Yönergeleri uygulayalım.

- Adı "t" sesi ile başlayan varlıkların görselini sayfanın aşağısındaki görsellerden yapıştıralım.

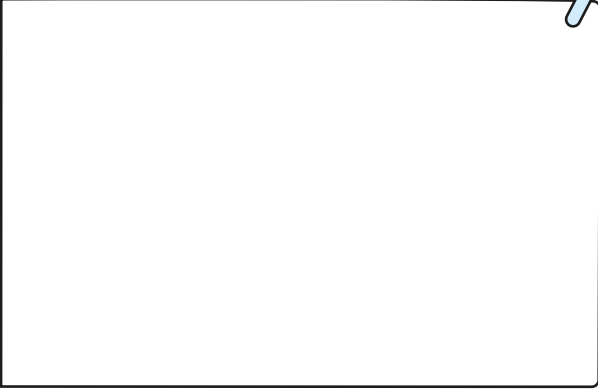

- Adı "t" sesi ile biten varlıkların görselini sayfanın aşağısındaki görsellerden yapıştıralım.

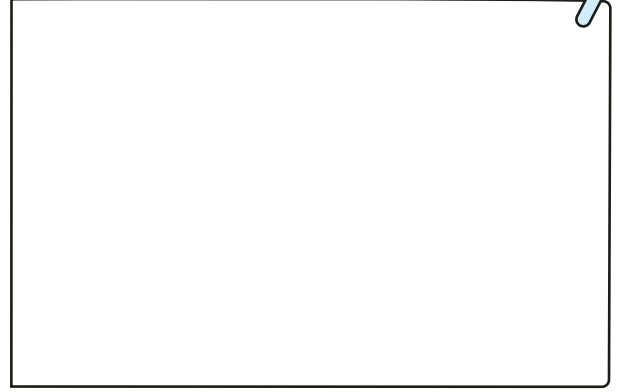

- Adında en çok "t" sesi olan görseli boyayalım.

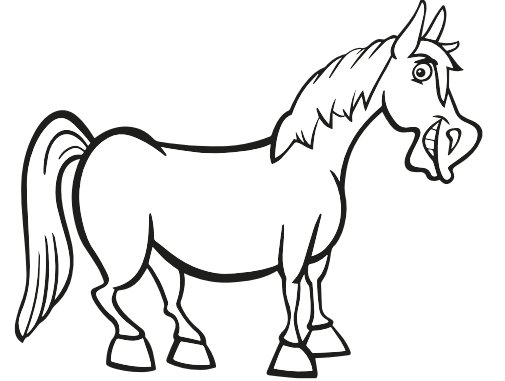
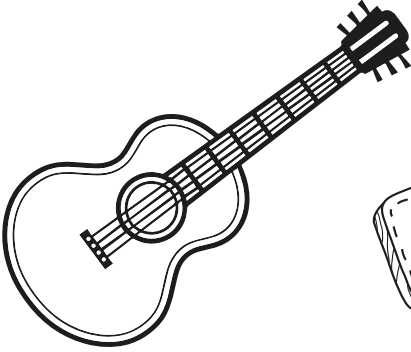

- Büyük "T" yazalım.

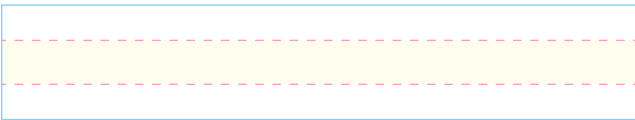
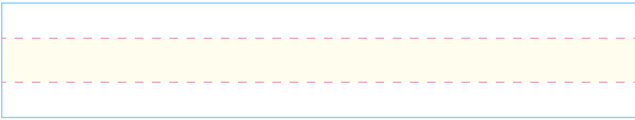

- Küçük "t" yazalım.

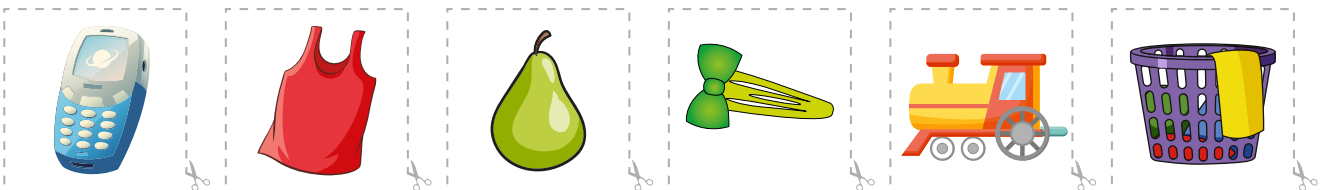

MATEMATİK

1

2

3

4

5

6

7

8

+

-

9

0

÷

×

=

?





1'den başlayıp birer ritmik sayarak noktaları birleştirelim.





1'den başlayıp birer ritmik sayarak noktaları birleştirelim.

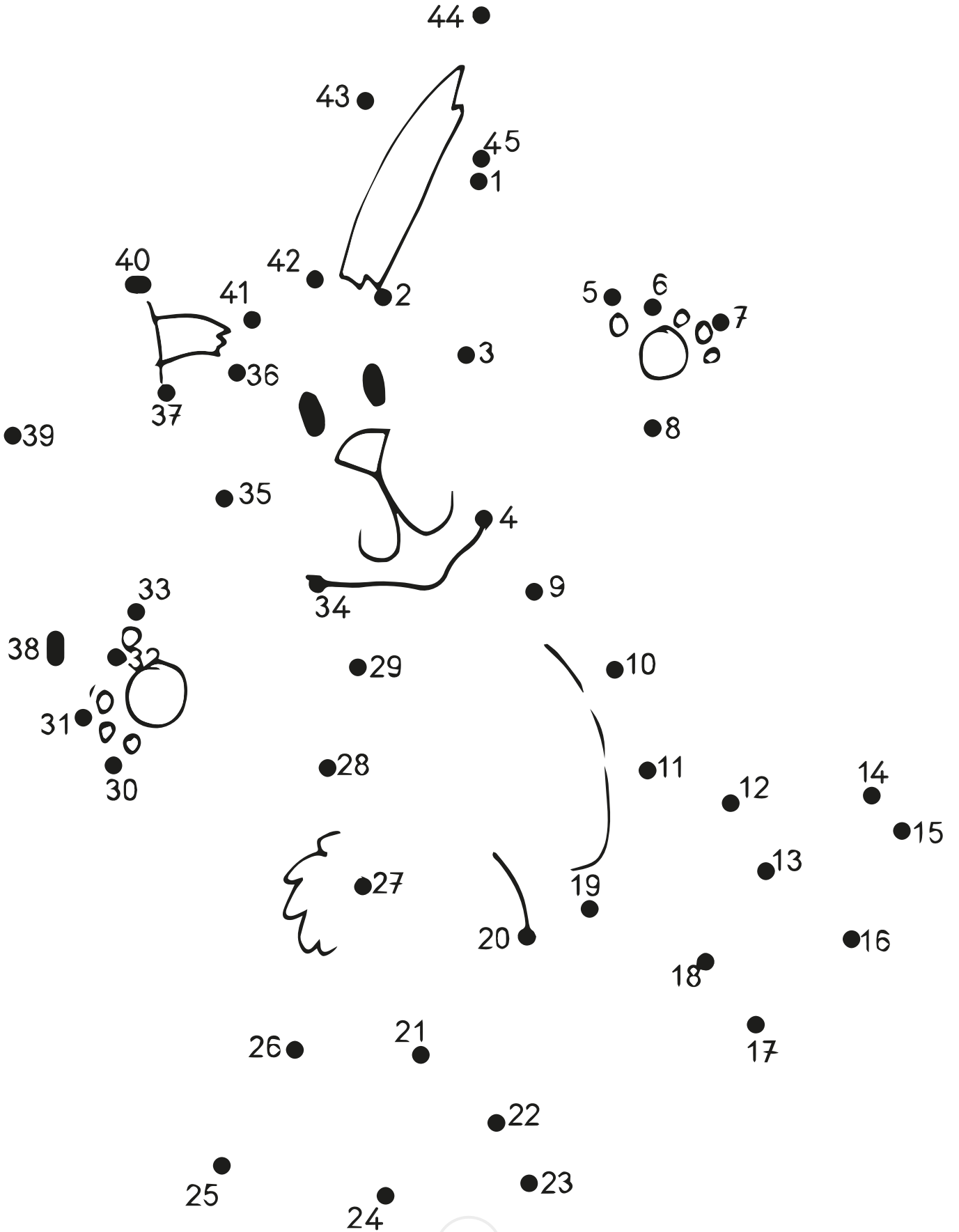



1'den başlayıp birer ritmik sayarak noktaları birleştirelim.

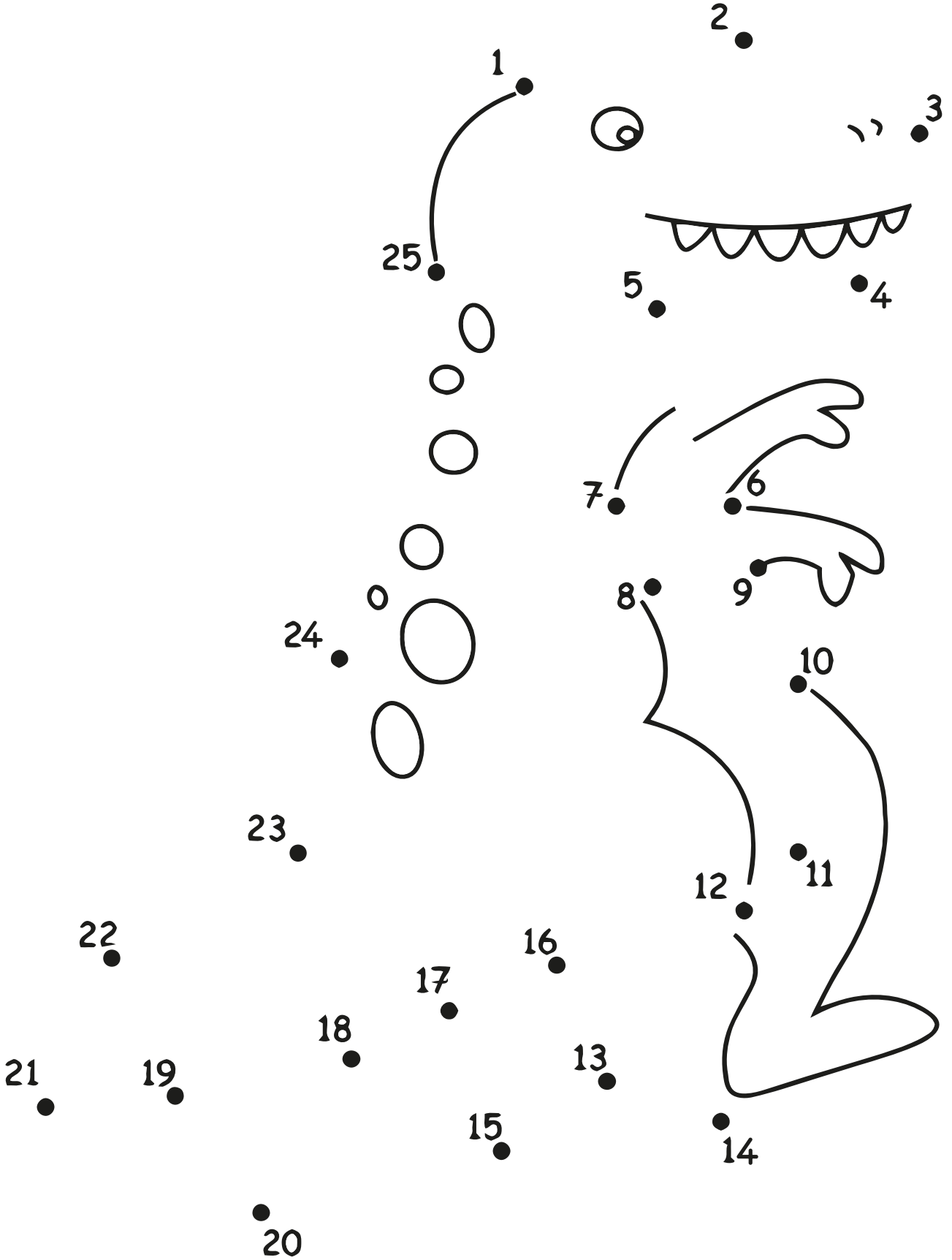



👉 Sayısı eşit olan nesneleri boyyalım.

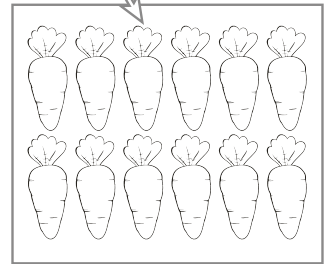
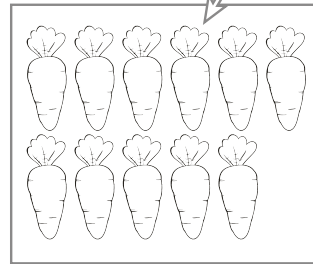
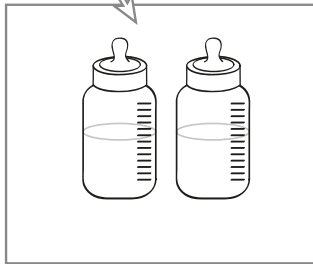
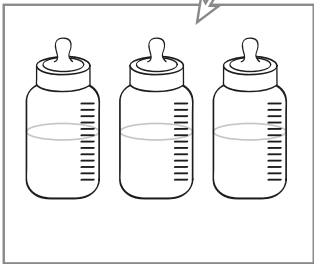
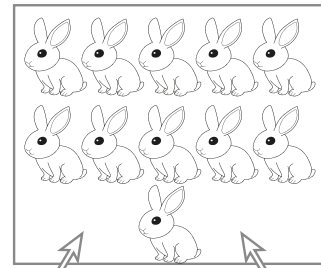
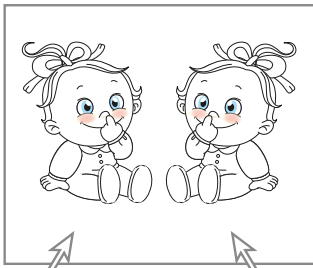
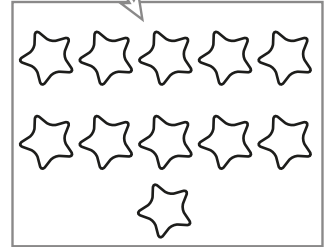
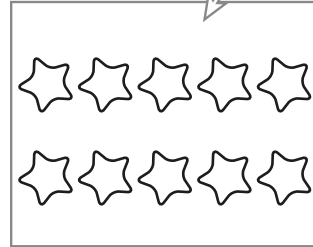
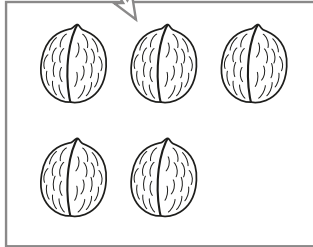
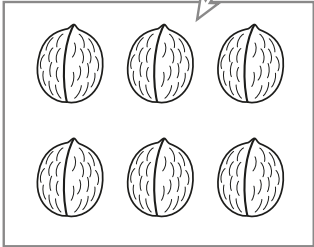
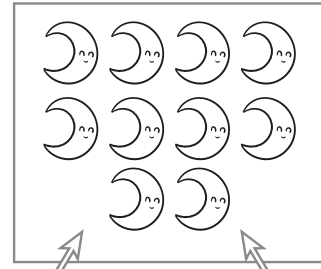
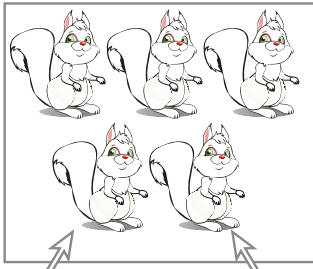
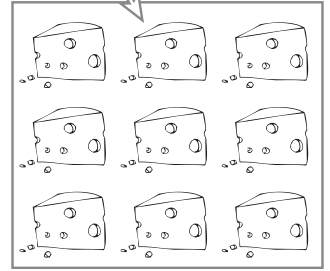
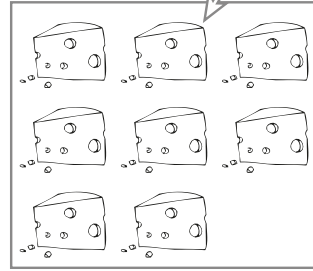
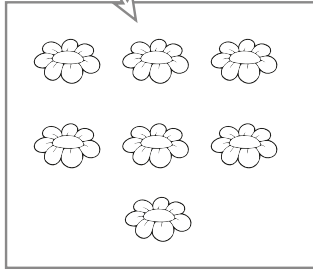
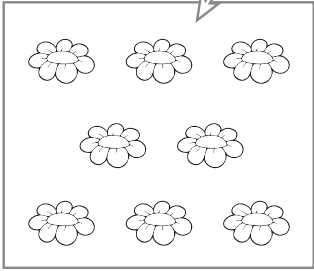
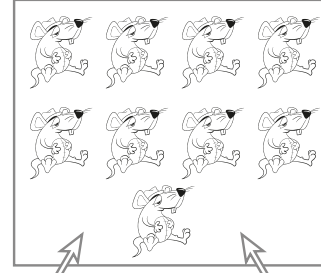
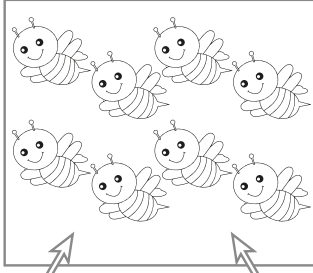



Nesne sayısı çok olan kutuyu boyayalım.

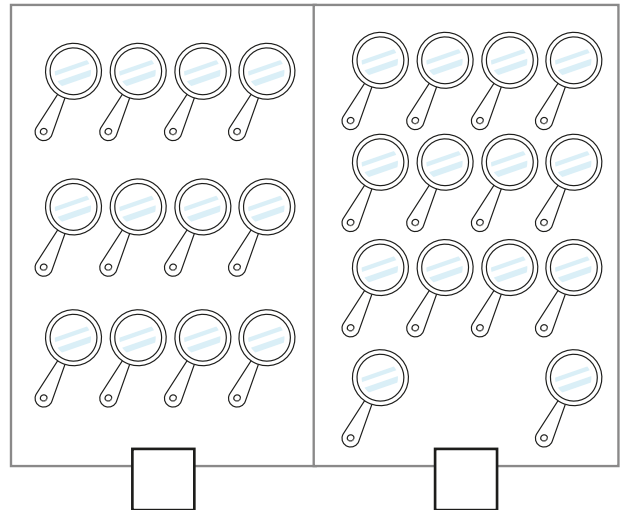
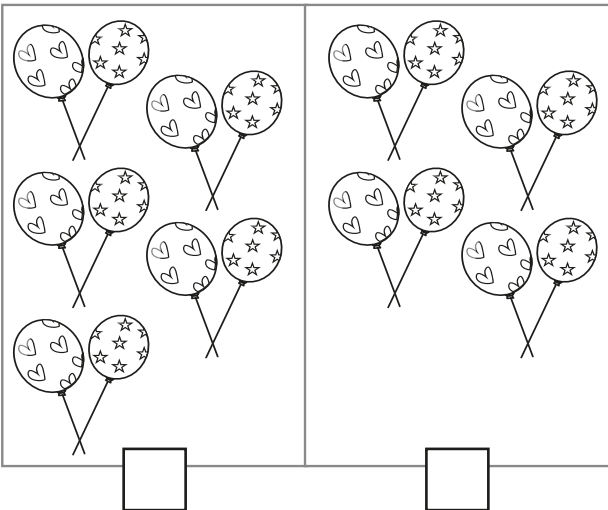
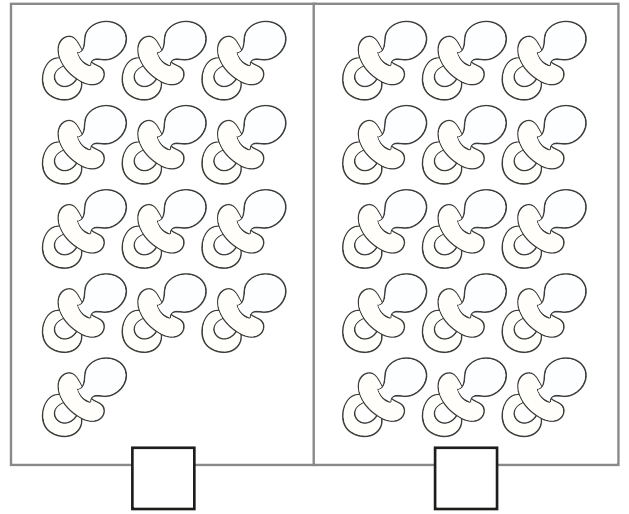
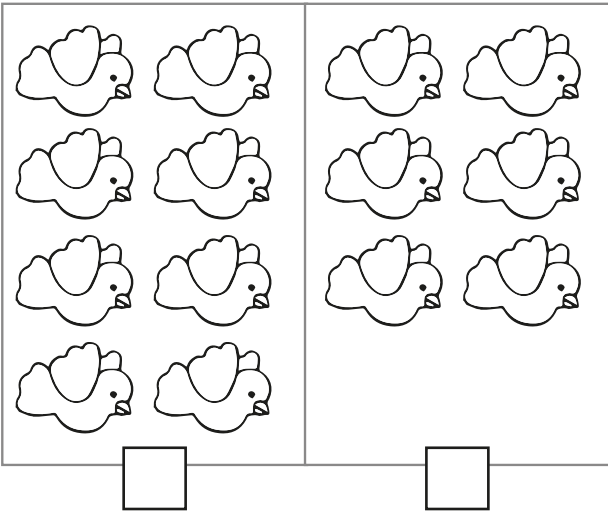
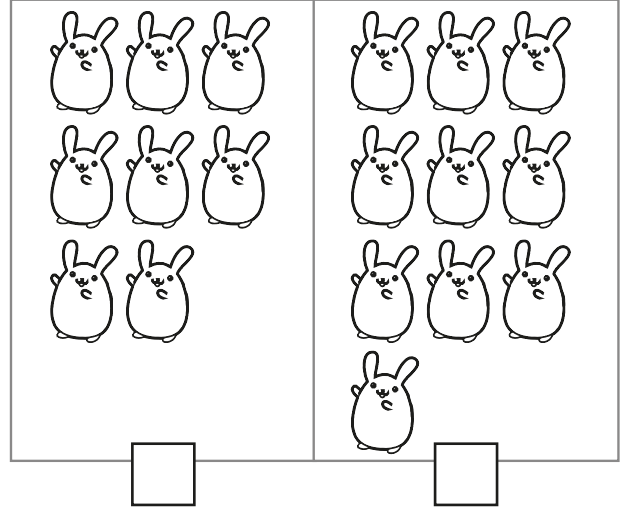
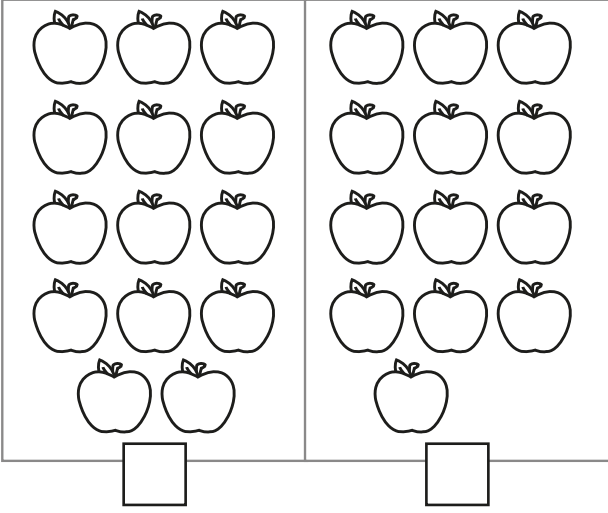



Nesne sayısı az olan kutuyu boyayalım.

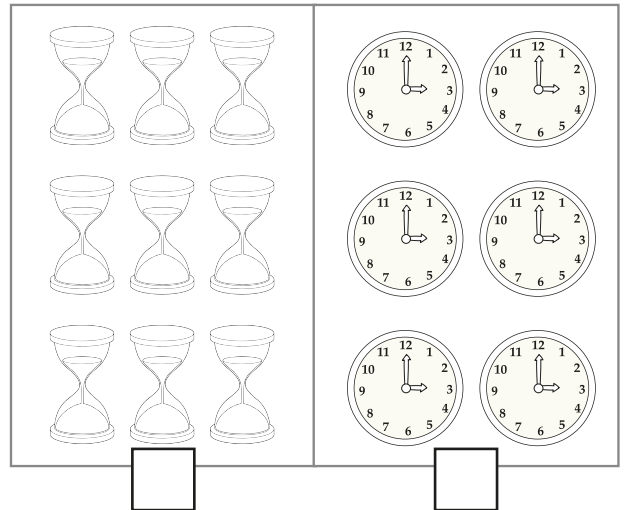
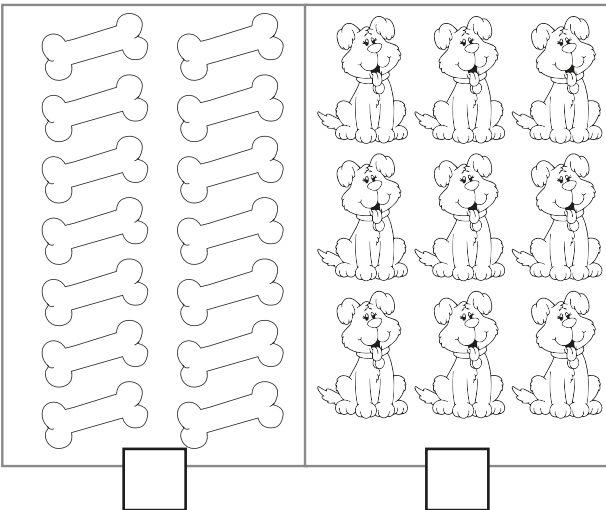
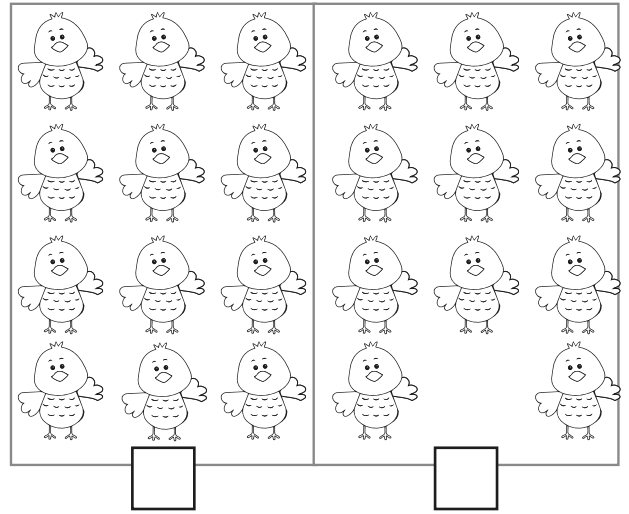
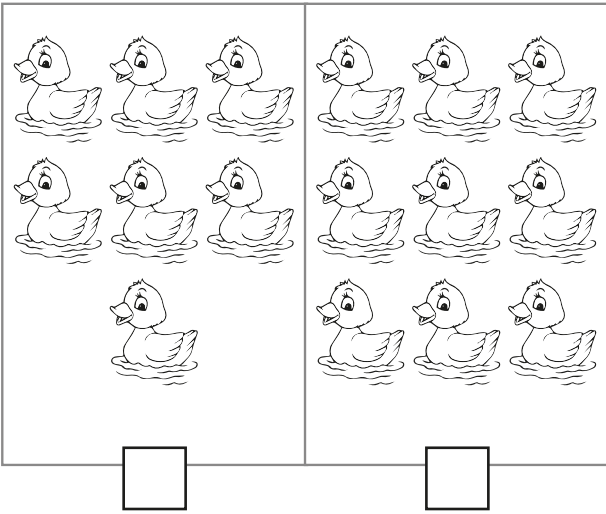
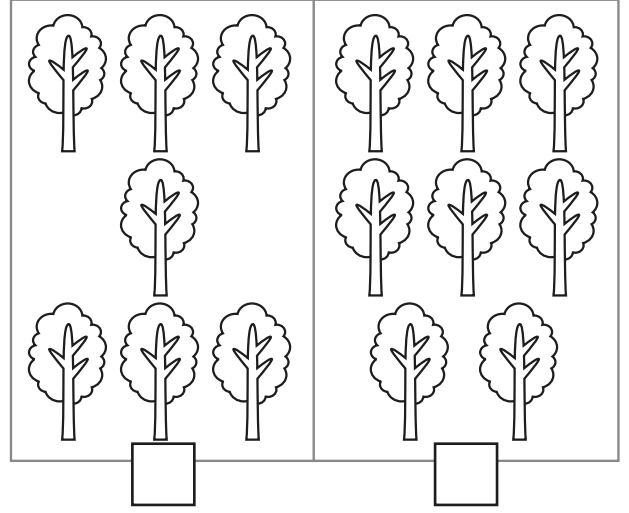
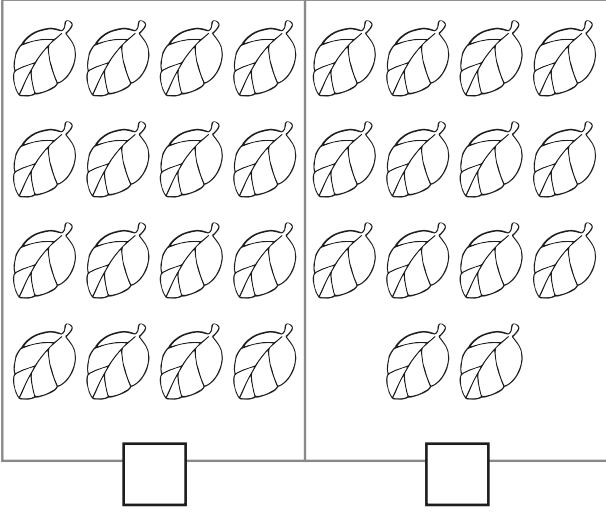



Aşağıda verilen gruplardan varlık sayısı az olanı bulup yanındaki kutuyu yeşile boyayın.

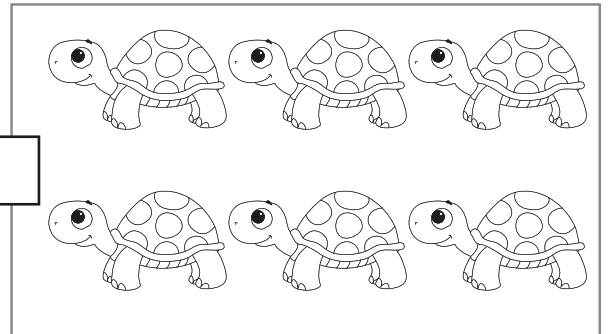
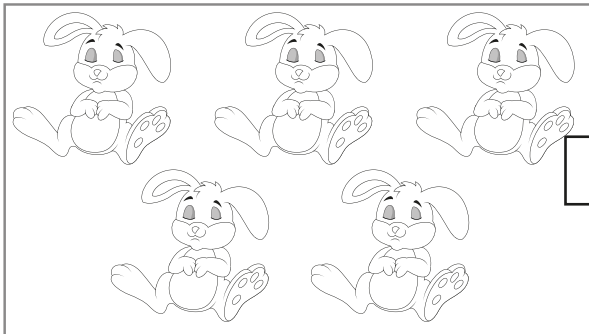
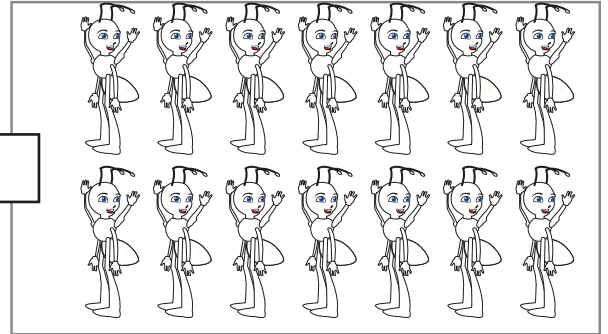
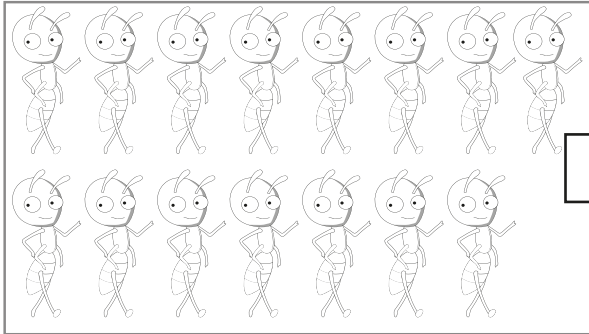
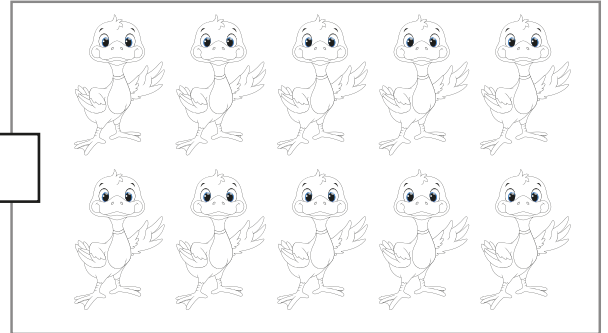
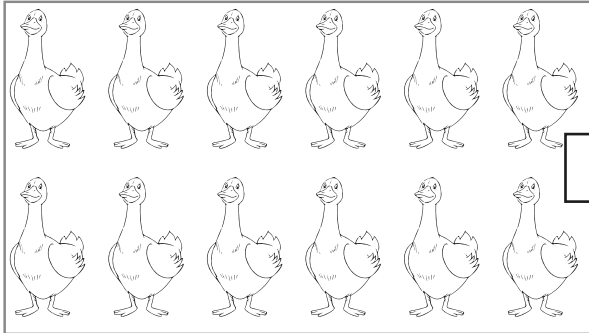
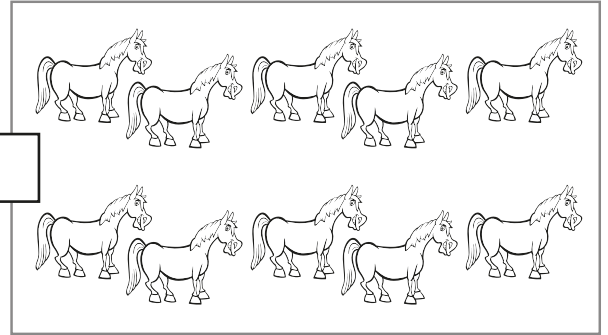
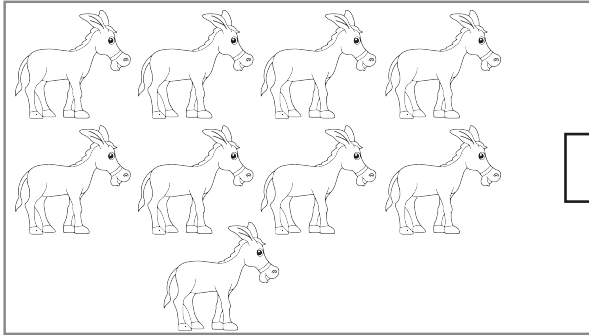
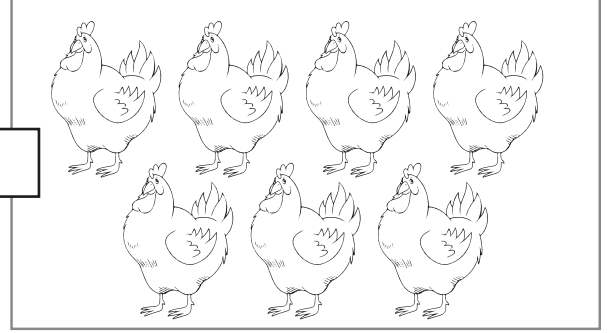
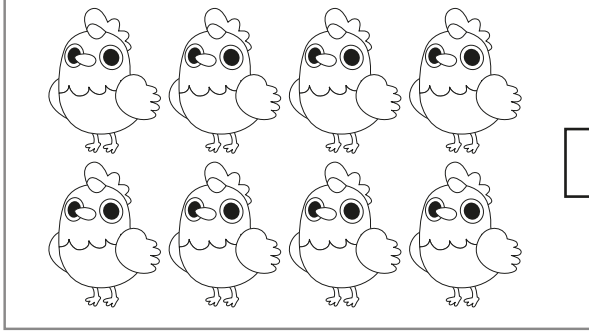



Aşağıda verilen gruplardan varlık sayısı çok olanı bulup yanındaki kutuyu maviye boyayın.

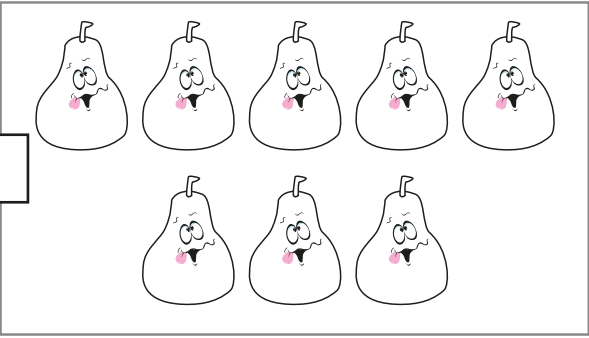
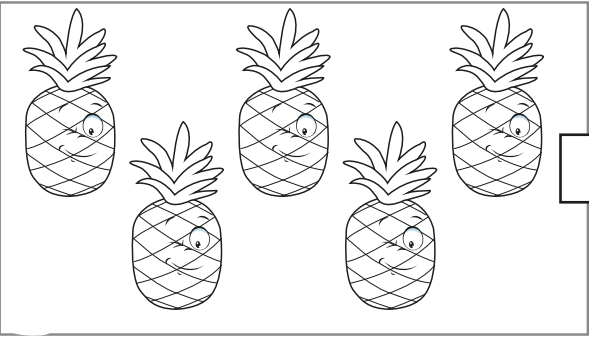
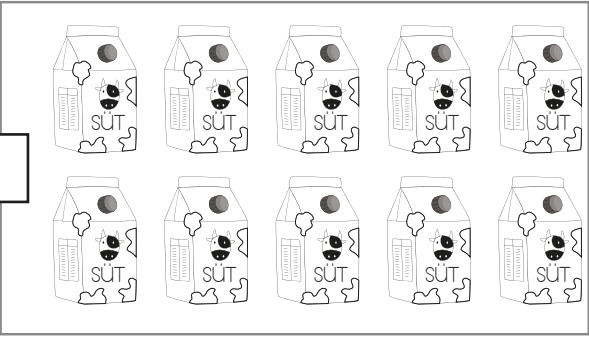
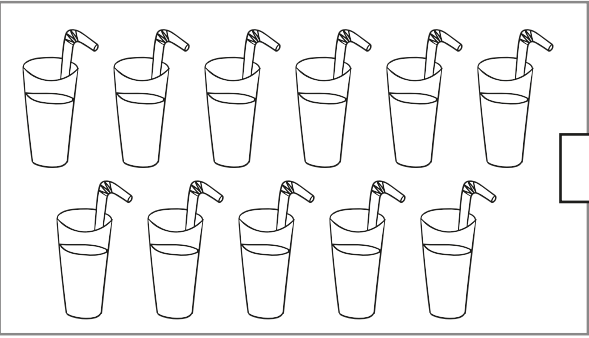
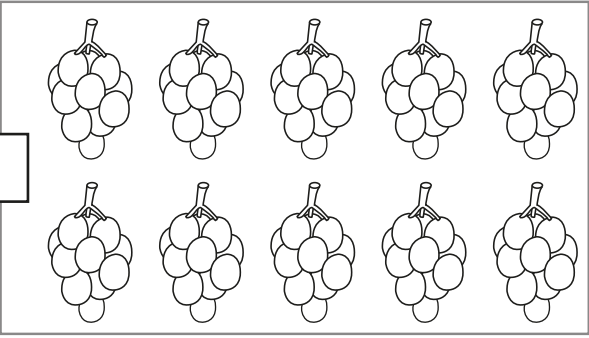
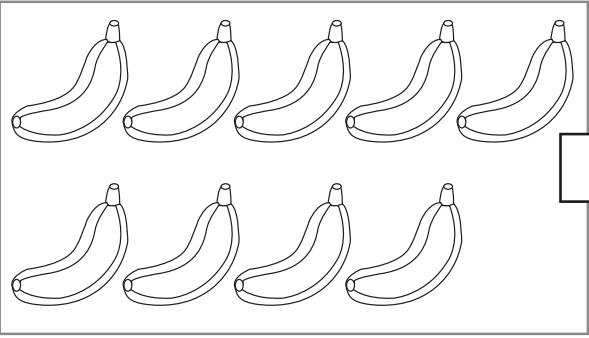
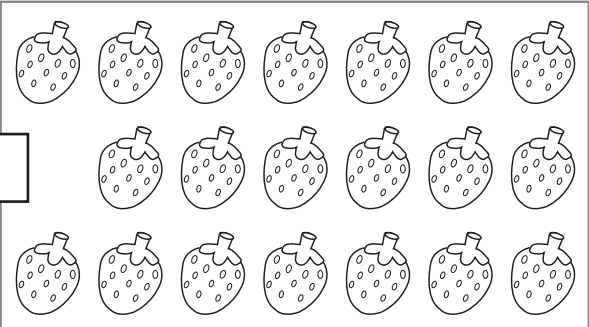
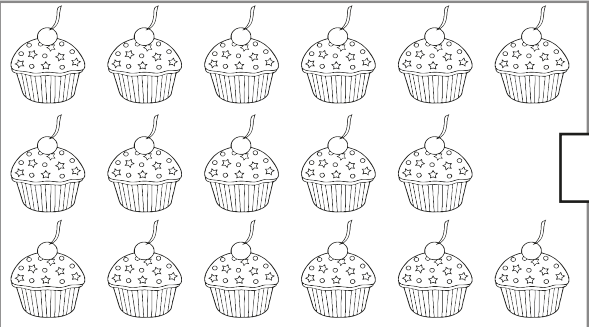
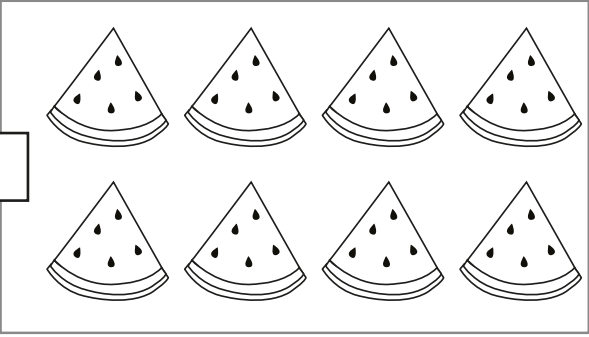
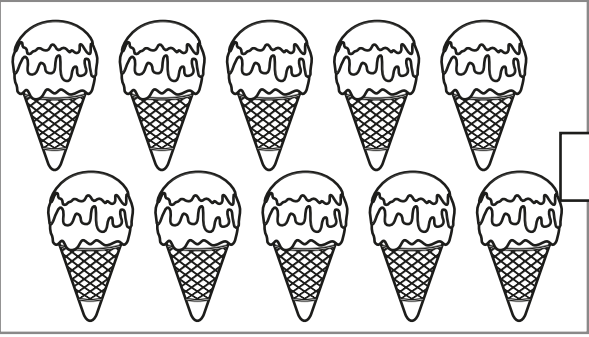



Ortadaki nesnelere az sayıda olan grubun üçgenini kırmızıya, çok sayıda olan grubun üçgenini maviye boyayalım.

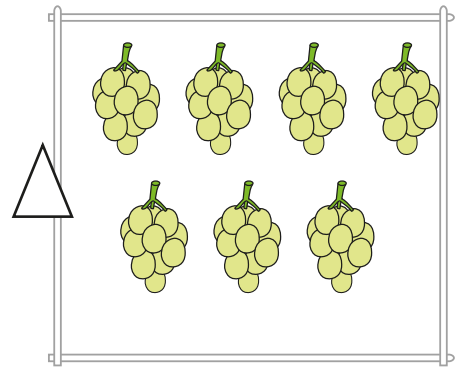
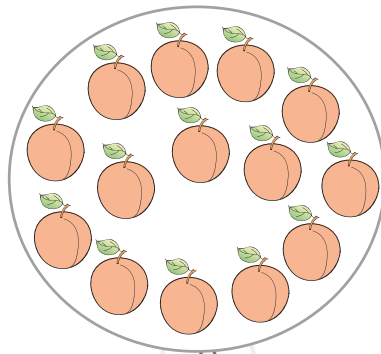
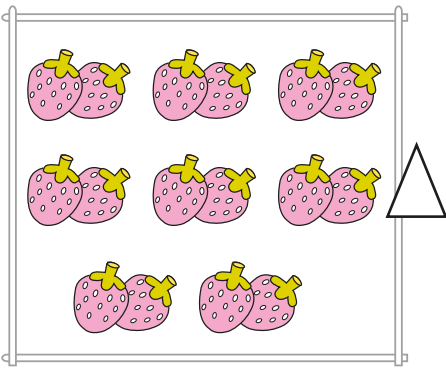
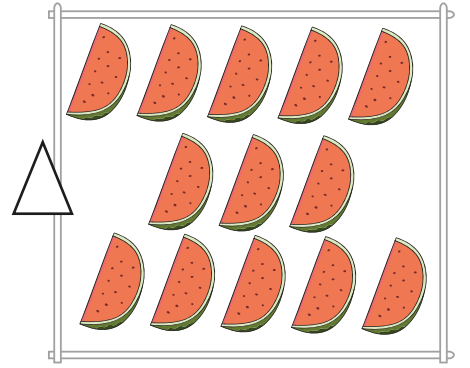
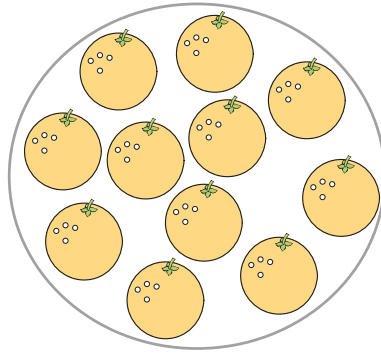
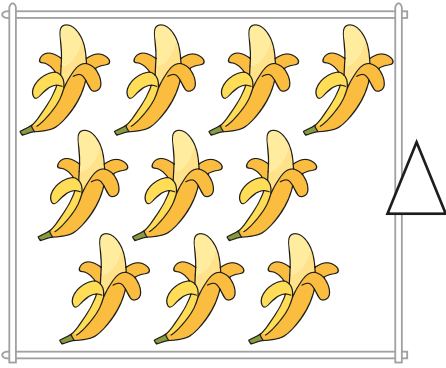
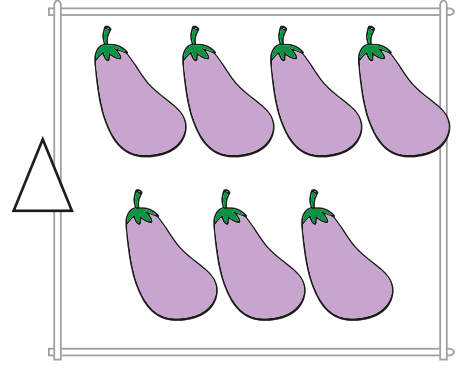
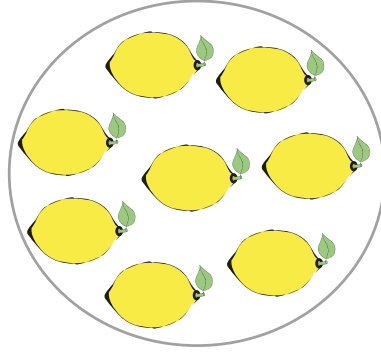
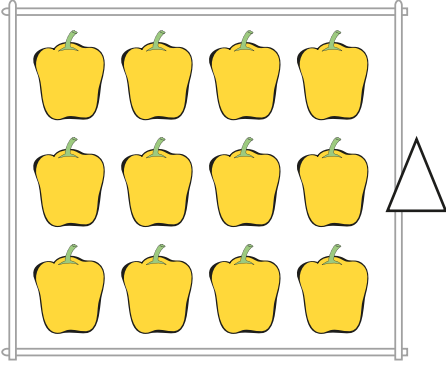
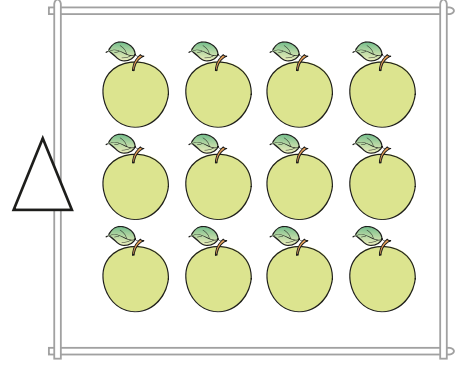
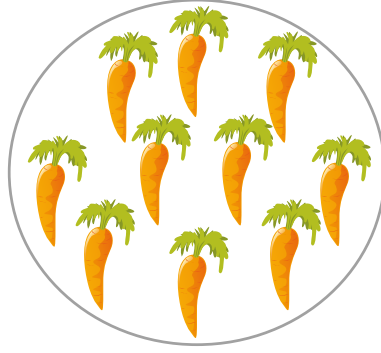
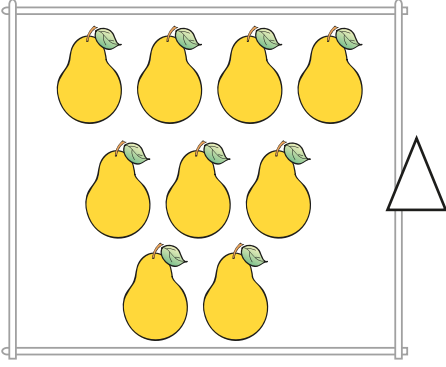



Belirtilen nesneleri sayalım. Sayılarını rakamla kutulara yazalım.





Belirtilen nesnelere sayalım. Sayılarını rakamla kutulara yazalım.

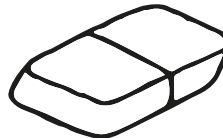
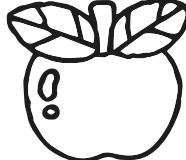
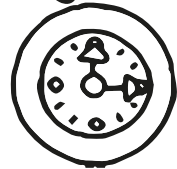
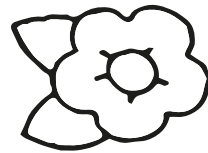
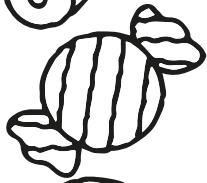
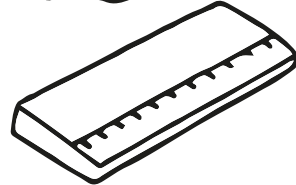
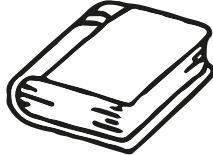
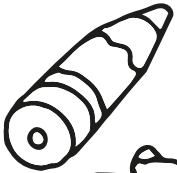



Belirtilen nesnelere sayalım. Sayılarını rakamla kutulara yazalım.

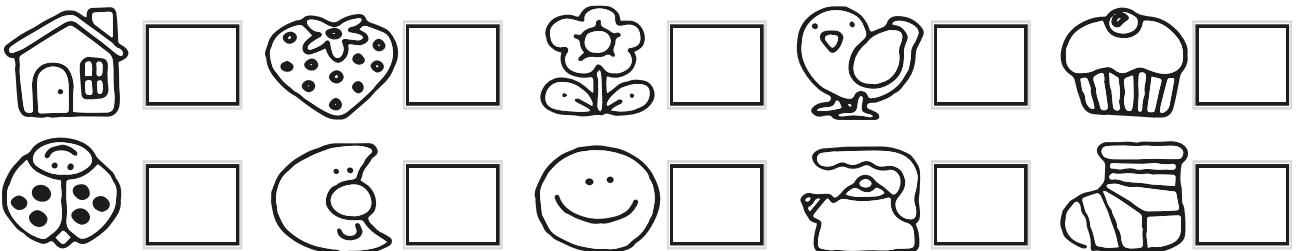



Belirtilen nesneleri sayalım. Sayılarını rakamla kutulara yazalım.

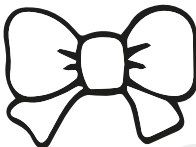
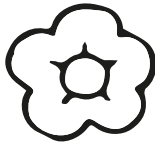



Belirtilen nesneleri sayalım. Sayılarını rakamla kutulara yazalım.

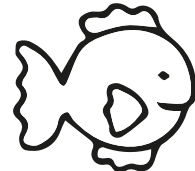
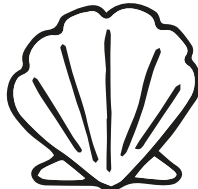
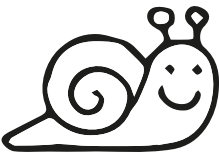
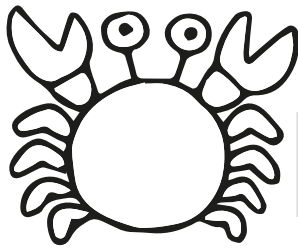
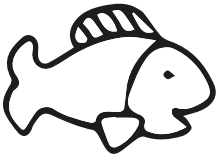



Aşağıdaki varlıkları birer birer sayalım ve kaç tane olduklarını yazalım.

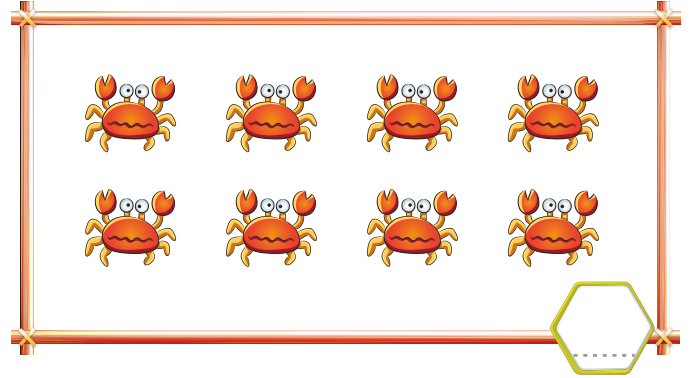
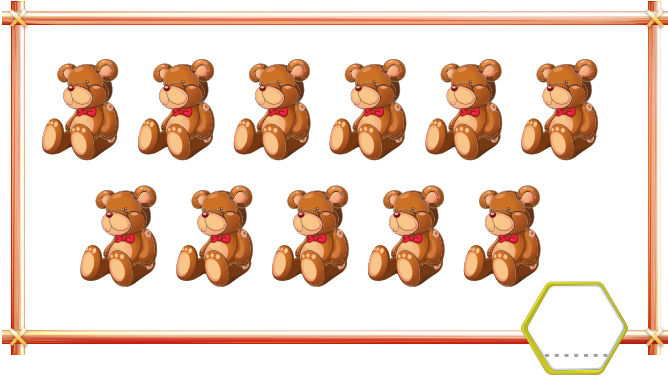
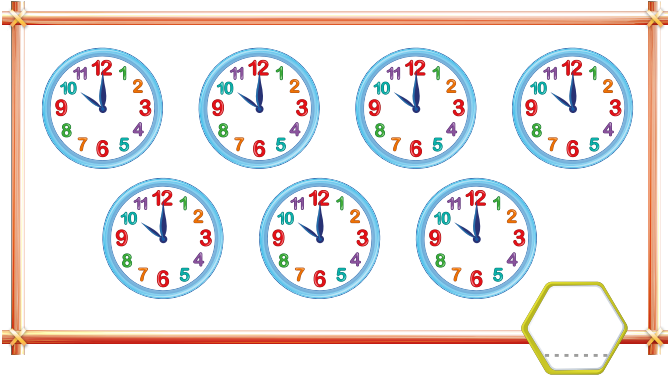

Belirtilen sayılardan başlayarak birer sayalım. Saydığımız sayıları kutulara yazalım.

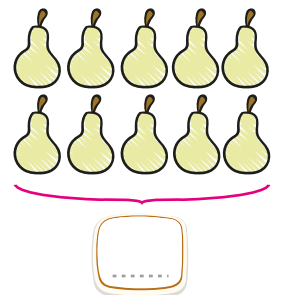
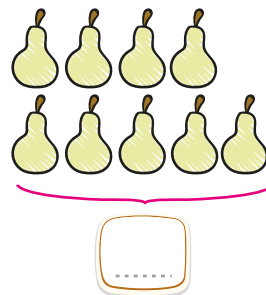
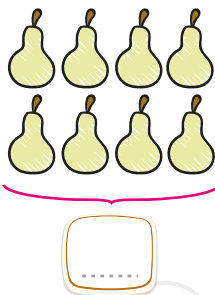
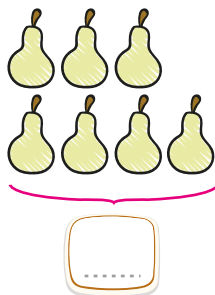
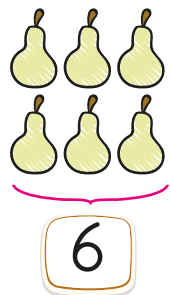
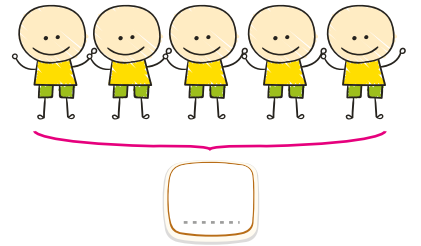
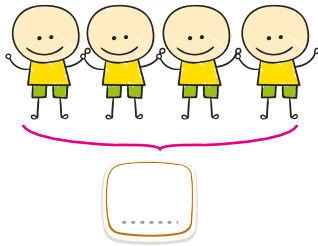



Aşağıdaki kurbağa sola giderse geriye doğru, sağa giderse ileriye doğru birer ritmik sayıyor. Buna göre noktalı yerleri dolduralım.

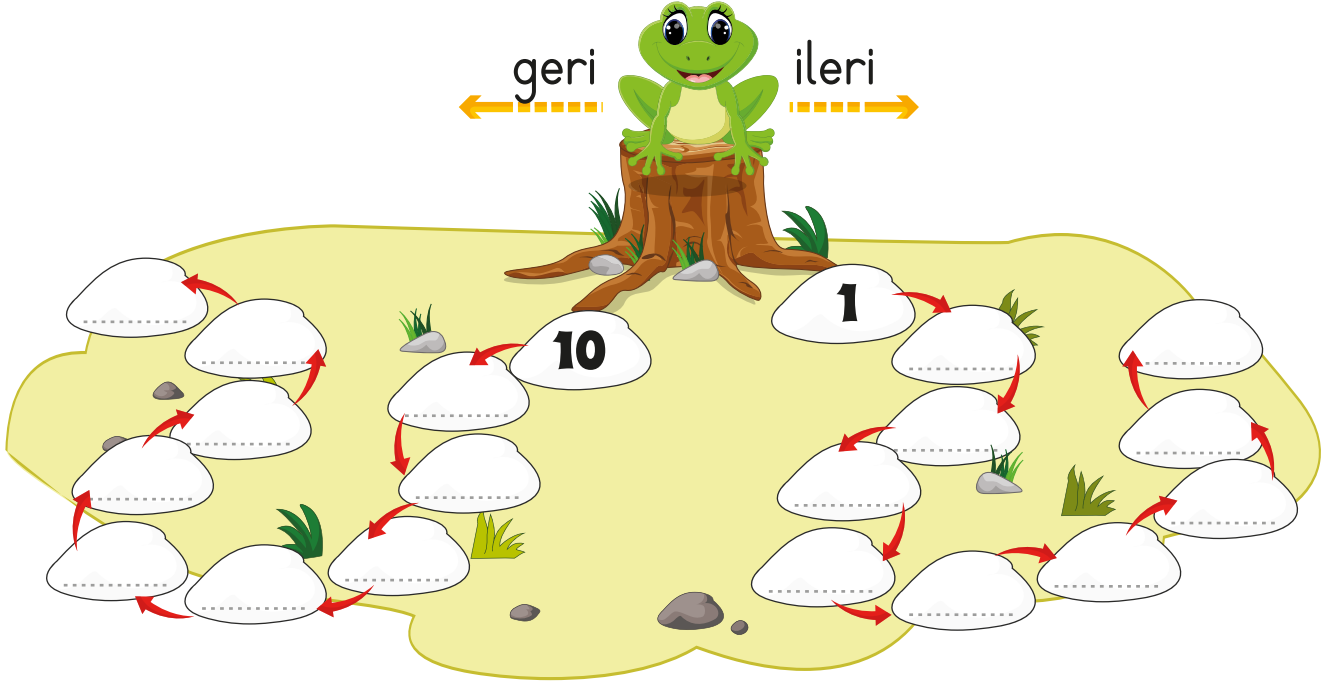

Belirtilen sayılardan başlayarak geriye doğru birer ritmik sayalım. Noktalı yerleri dolduralım.

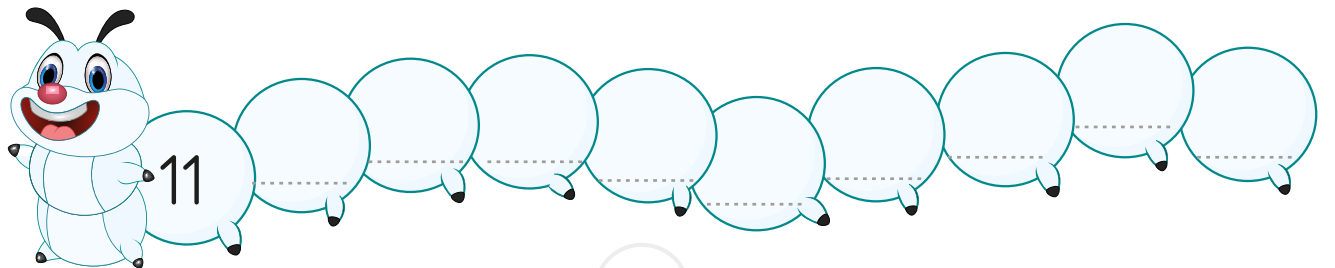
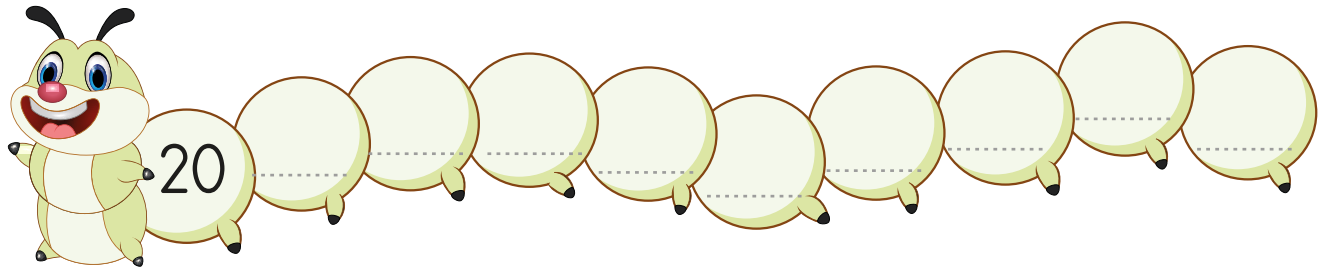
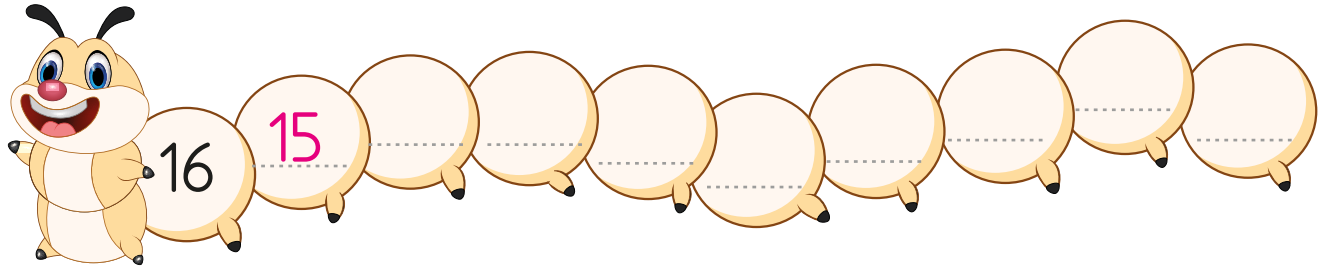



Misketleri ikişer sayıp yazalım.

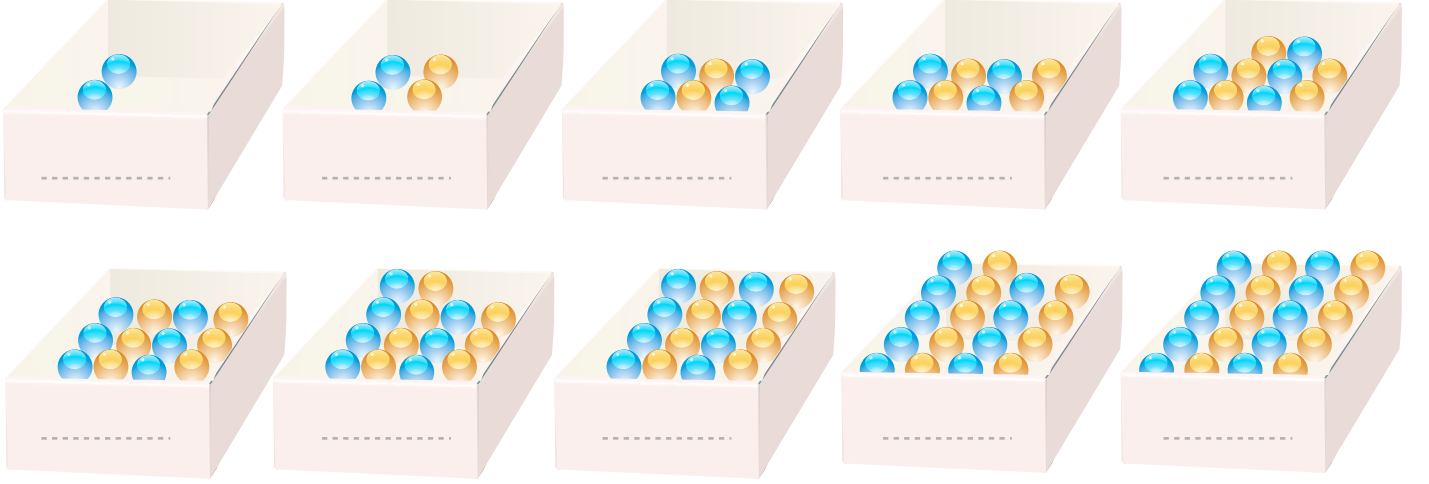

Aşağıdaki blokları ikişer sayarak yazalım.

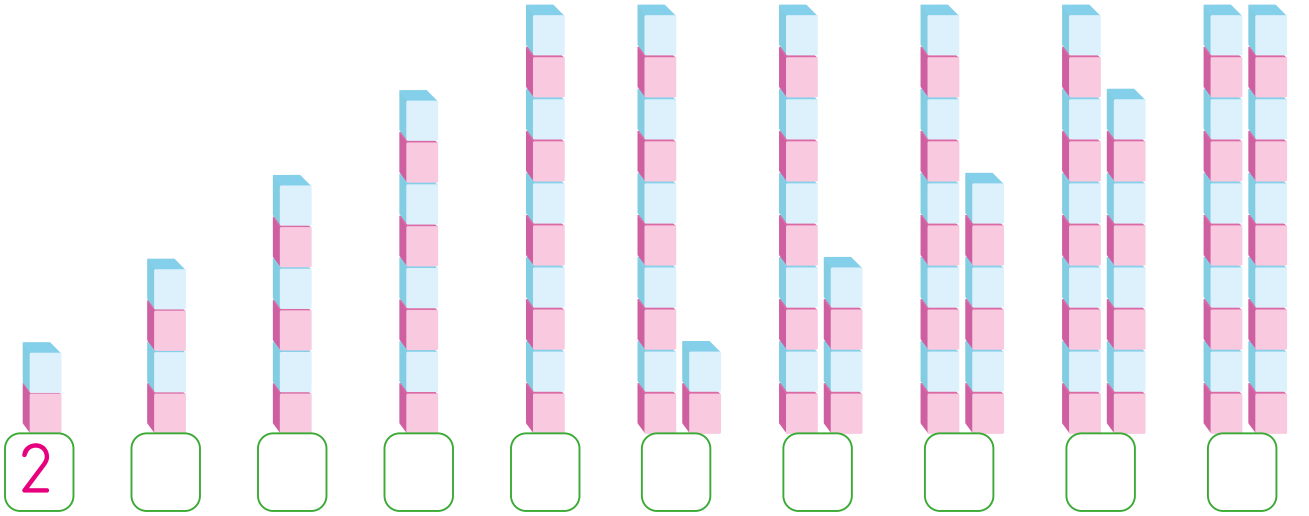

20'den geriye ikişer sayıp yazalım.

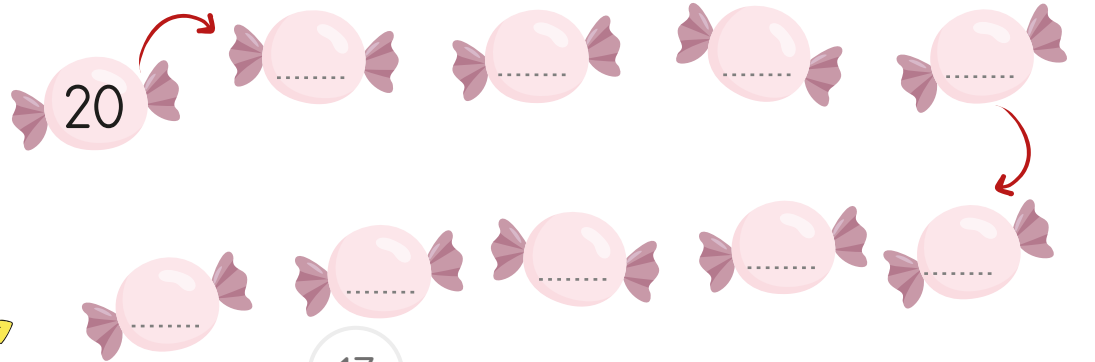



İleriye doğru ritmik sayarken verilmeyen sayıları yazalım.

7	8	9	11	12	15
2	4	6	8	10	14	16
10	15	25	30	35	40	45	50
12	13	14	15	17	19
10	30	40	50	60	70	80	90



Geriye doğru ritmik sayarken verilmeyen sayıları yazalım.

20	19	18	16
14	12	10	8
13	12	10	9

20	18	16	12
7	6	4	3
10	8	6	4



Doğru olanın kalbini boyayalım.

► On beşten başlayarak ileriye beşer ritmik sayalım.

Dördüncü sırada hangi sayıyı söyleriz?

♥ 30

♥ 35

► Dörtten başlayarak ileriye ikişer ritmik sayalım. Yedinci sırada hangi sayıyı söyleriz?

♥ 14

♥ 16

18



29 EKİM CUMHURİYET BAYRAMIMIZ

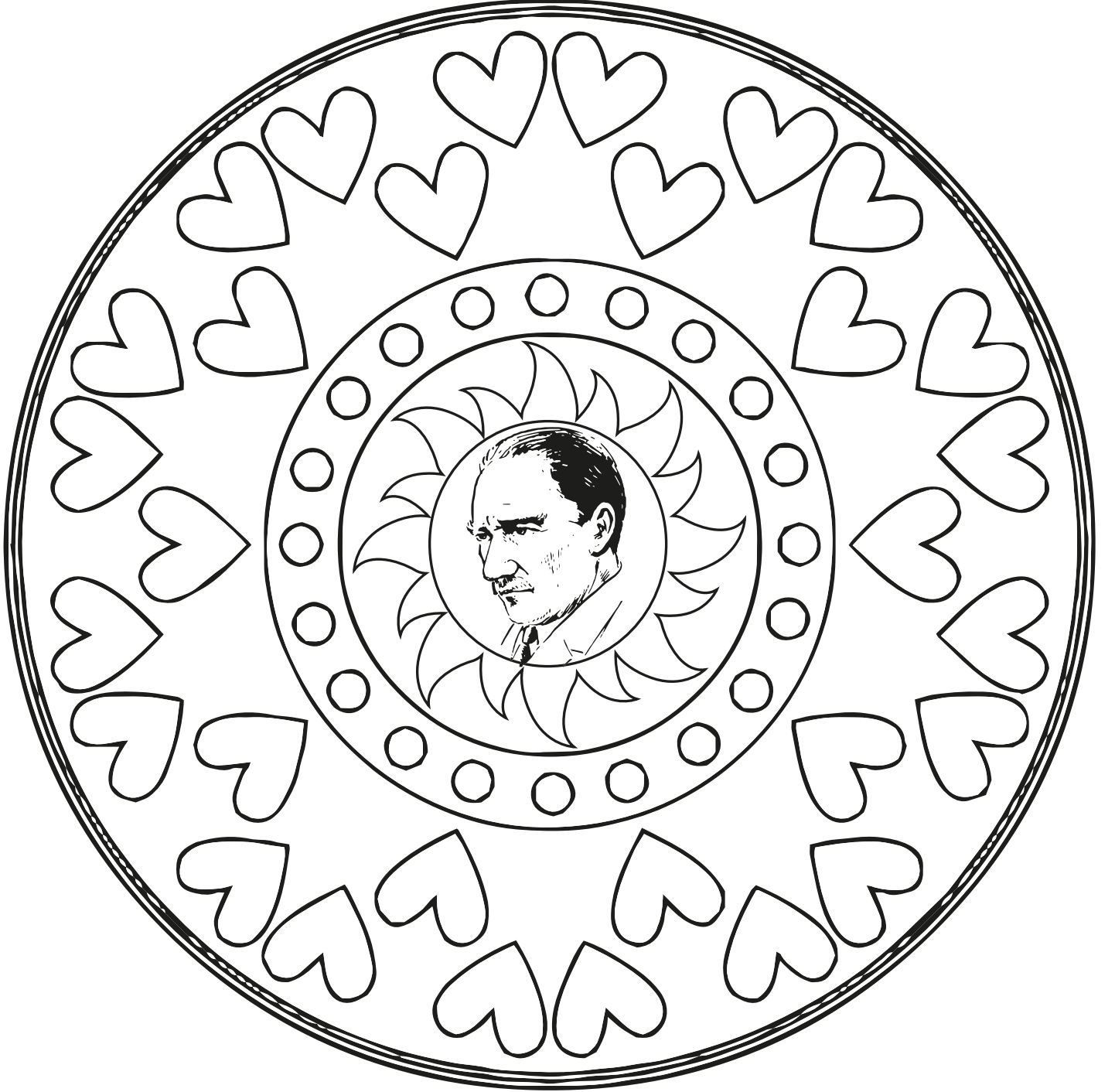

KUTLU OLSUN



Cumhuriyet Bayramı denilince aklına gelenleri çizer misin?

29 EKİM CUMHURİYET BAYRAMI



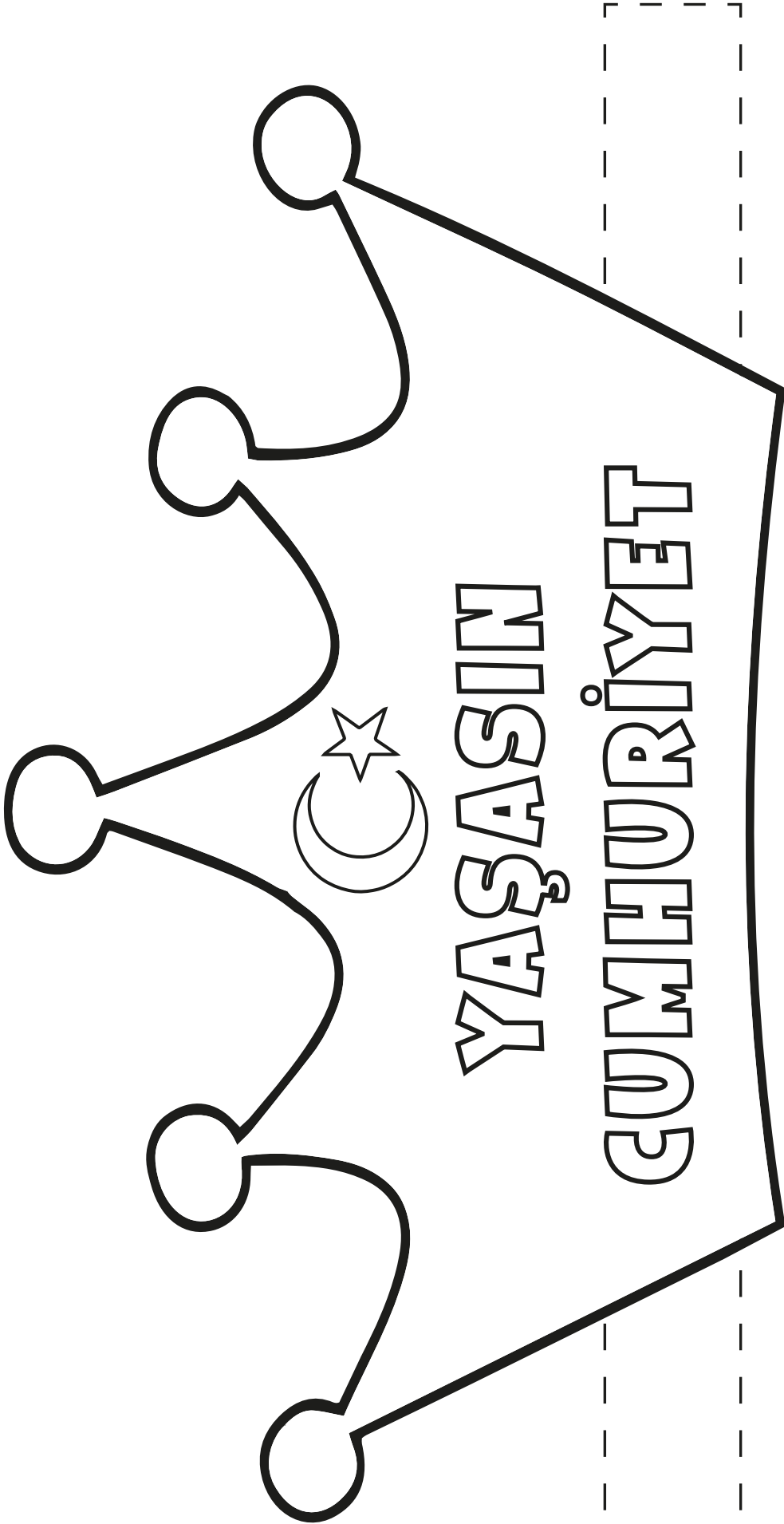



Cumhuriyet bayramında hissettiğin duyguya göre görseli tamamlar mısın?

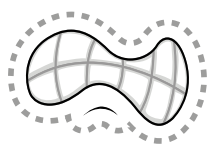
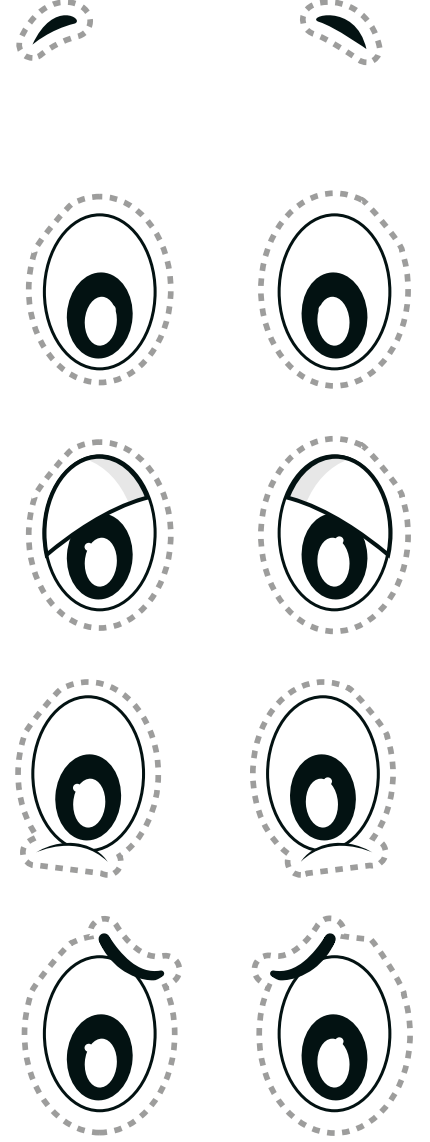
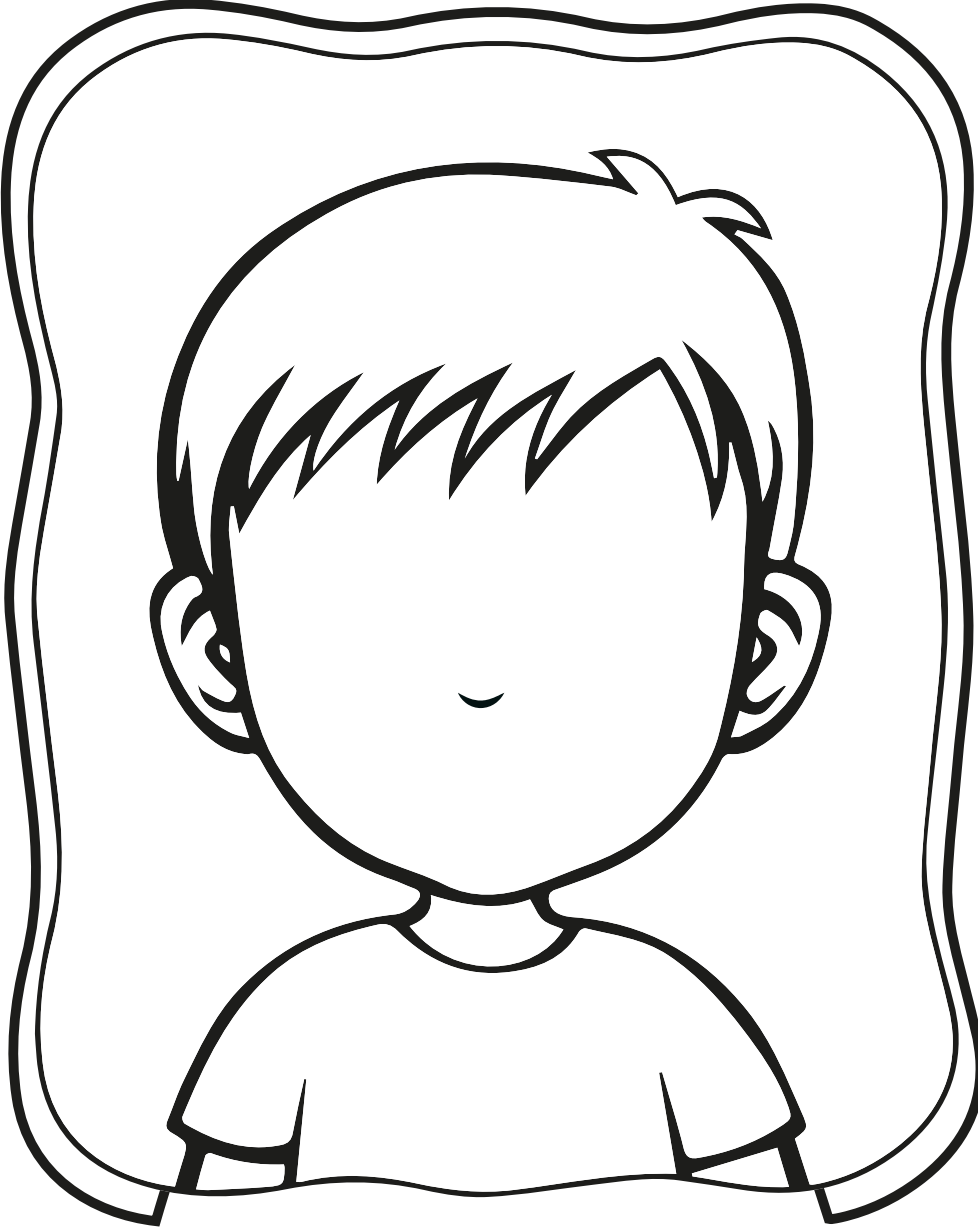



Cumhuriyet bayramında hissettiğin duyguya göre görseli tamamlar mısın?

