



İ VE N SESİ ÇALIŞMALARI





👉 Varlıkların isimlerini söyleyelim. Görselleri boyayalım.

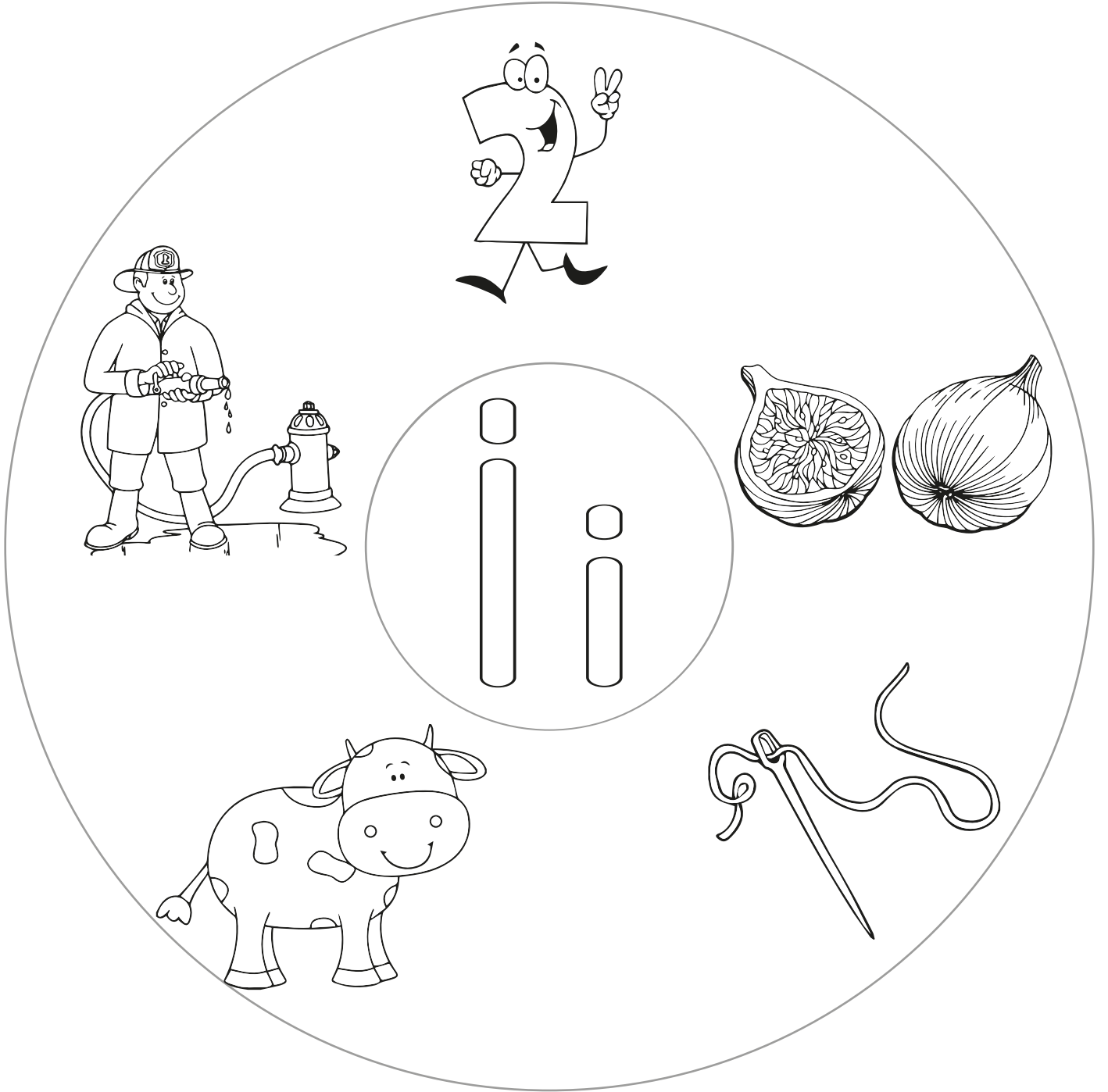

👉 Adında "i" sesi bulunan varlıkları işaretleyelim.

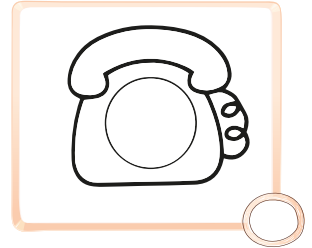
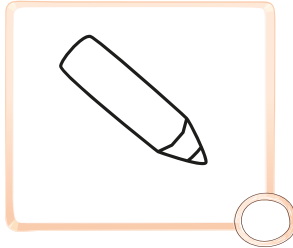
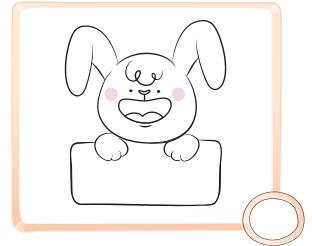
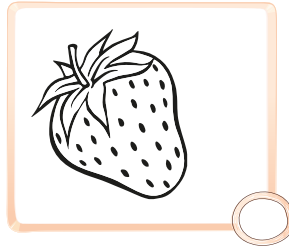
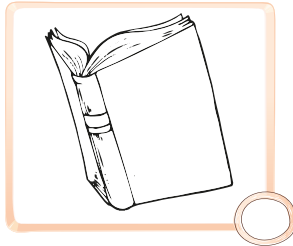
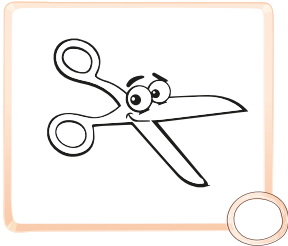
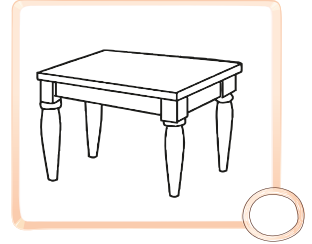
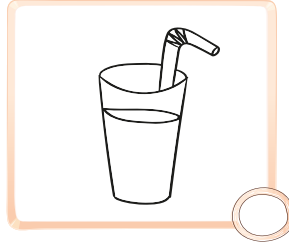
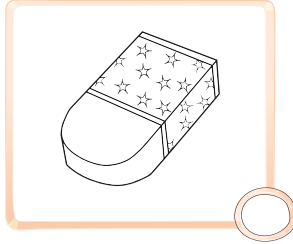
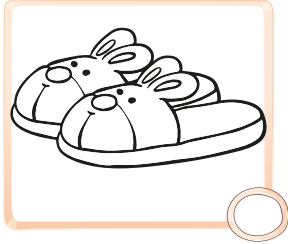

👉 "i" sesi ile başlayan varlıkları boyyalım.

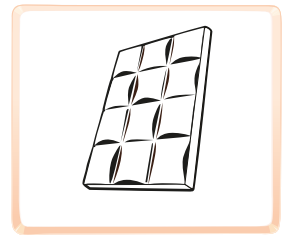
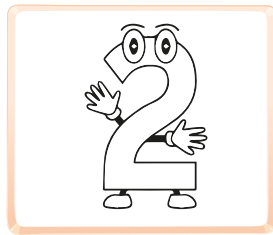
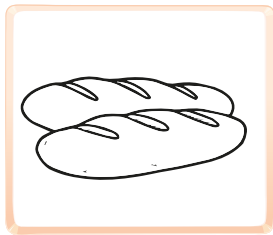
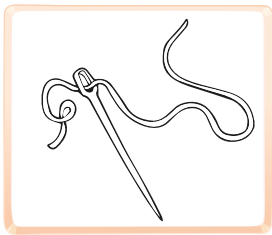
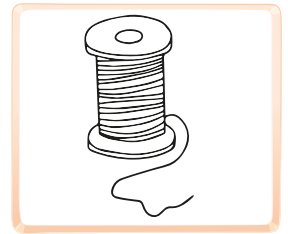
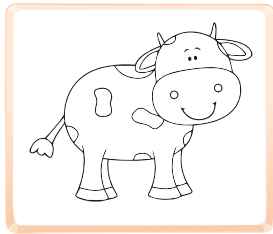
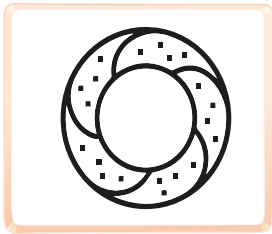
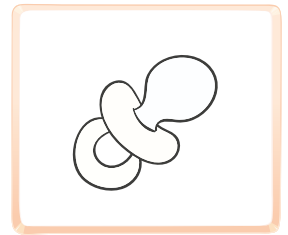
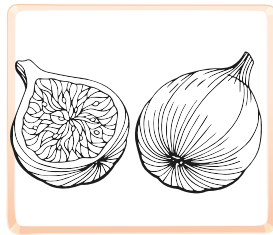
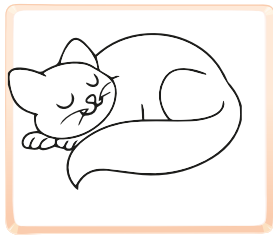
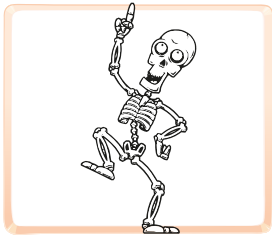

☞ "i" sesi başta ise baştaki, ortada ise ortadaki, sonda ise sondaki şekli işaretleyelim.

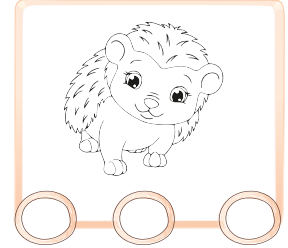
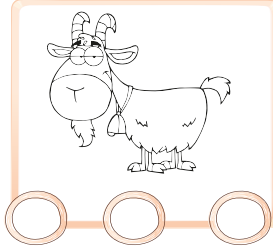
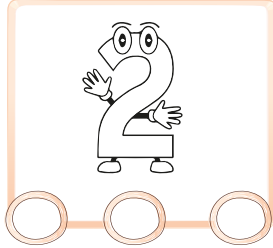
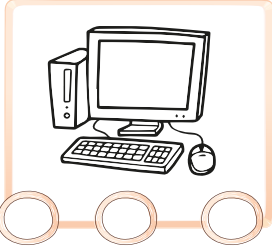
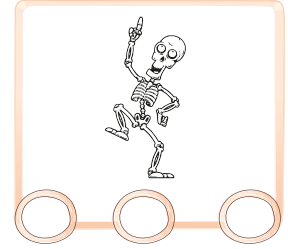
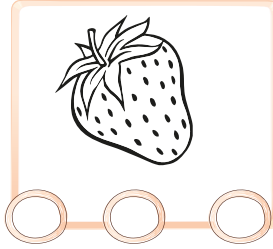
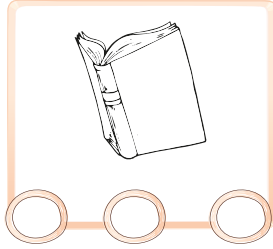
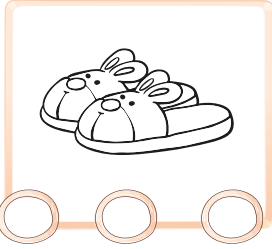
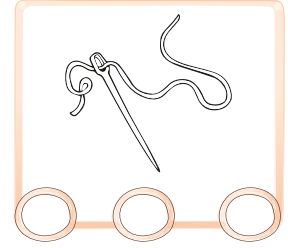
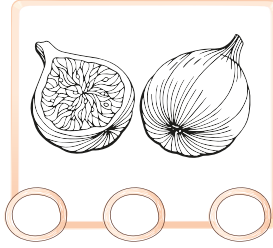
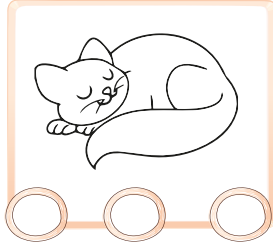
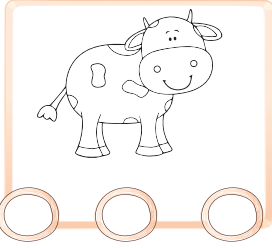

☞ "i" harflerini yuvarlak içine alalım.

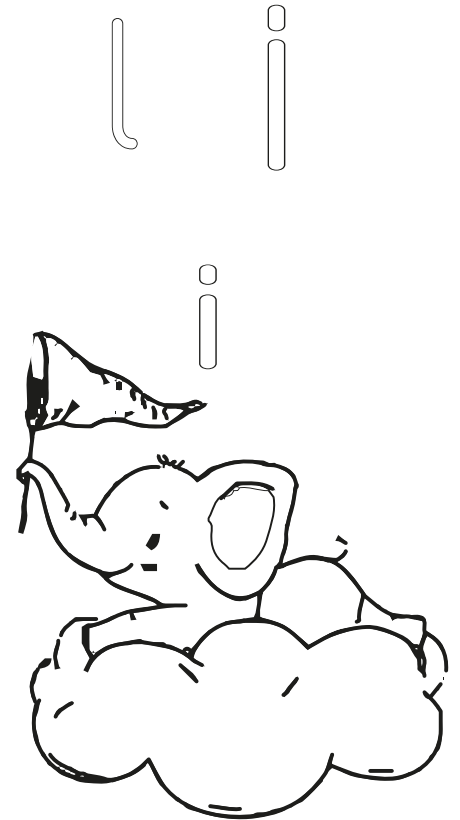
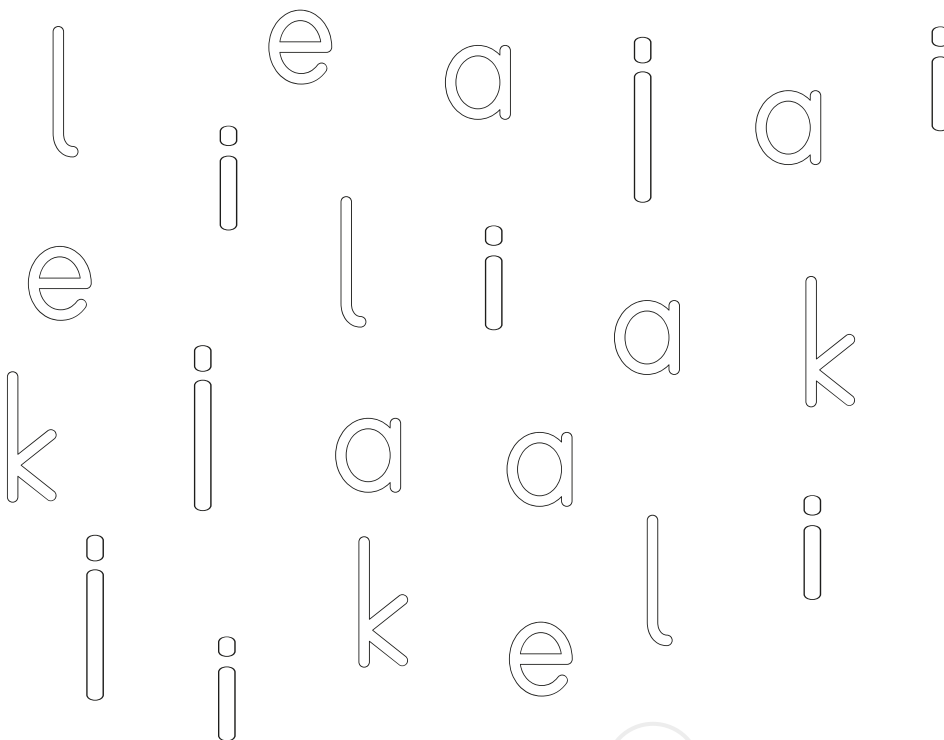

☞ Büyük "İ" harfinin yazılış yönüne dikkat edelim. İçinden kalemimizle geçelim.

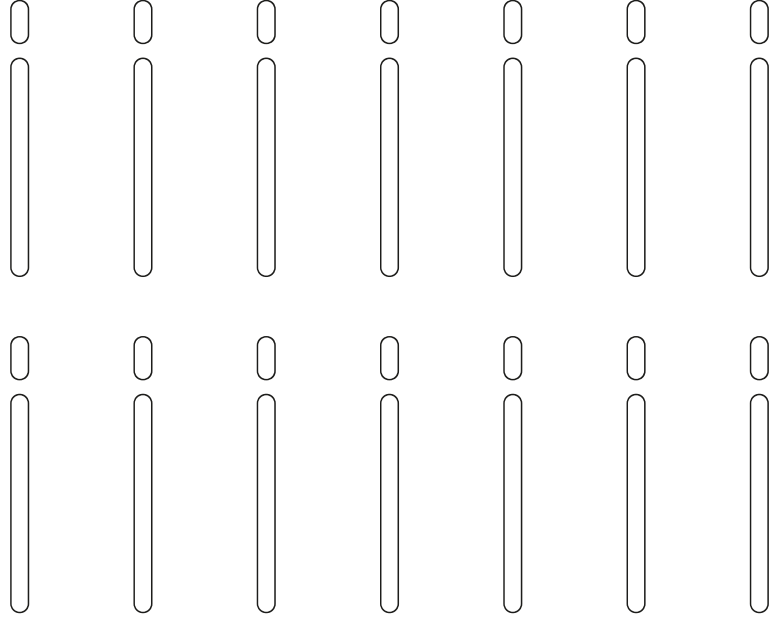
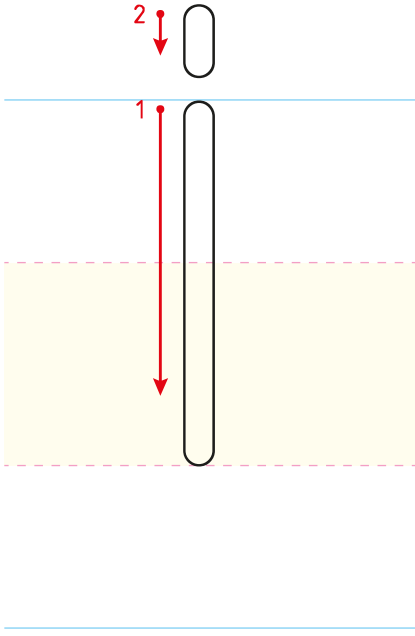

☞ "İ" harfinin yazılı olduğu balonları boyayalım.

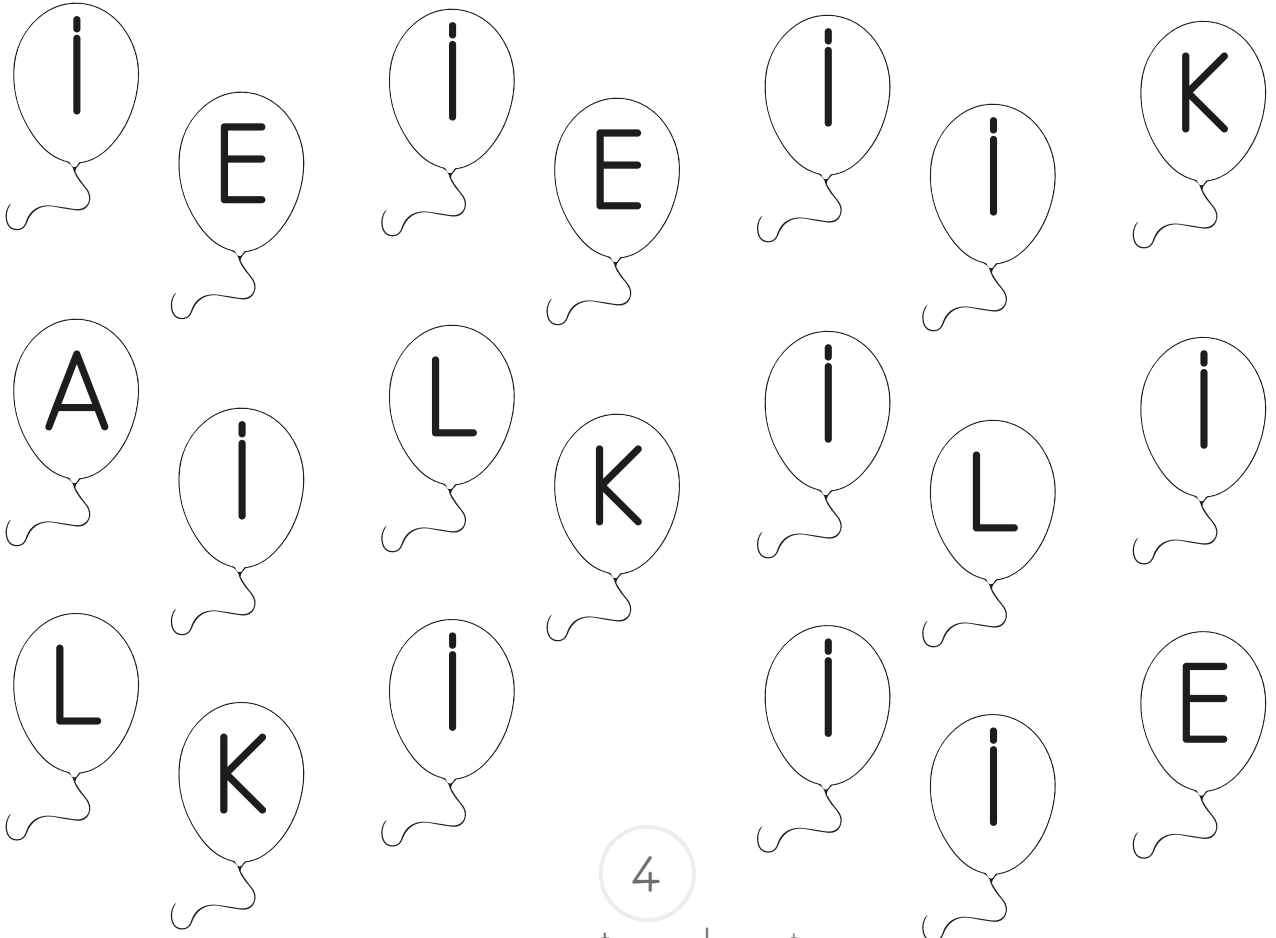

Yönergeleri uygulayalım.

• "İ" harfini boyayalım.



• "İ" harflerini bulup yuvarlak içine alalım.

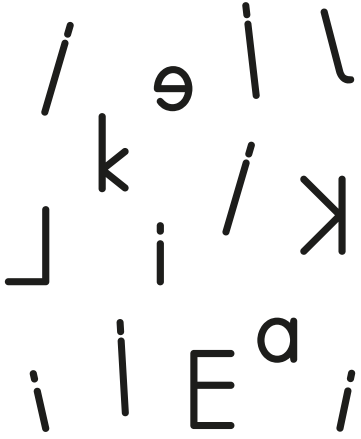

• Noktaları birleştiririm.



Yazma yönlerine dikkat ederek "İ" harfini yazalım.

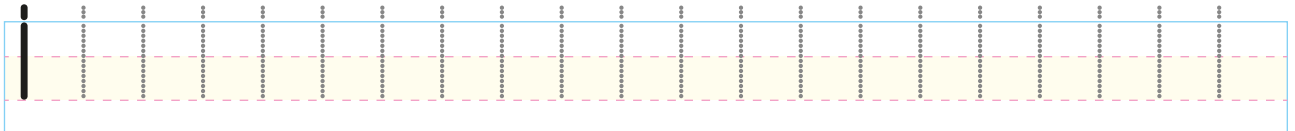
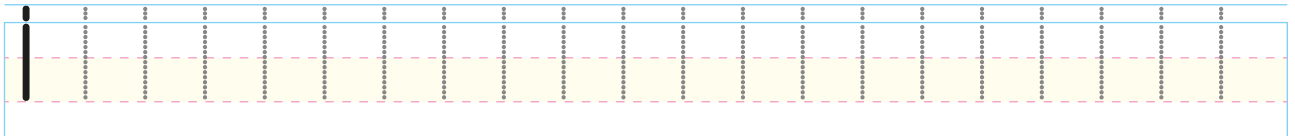
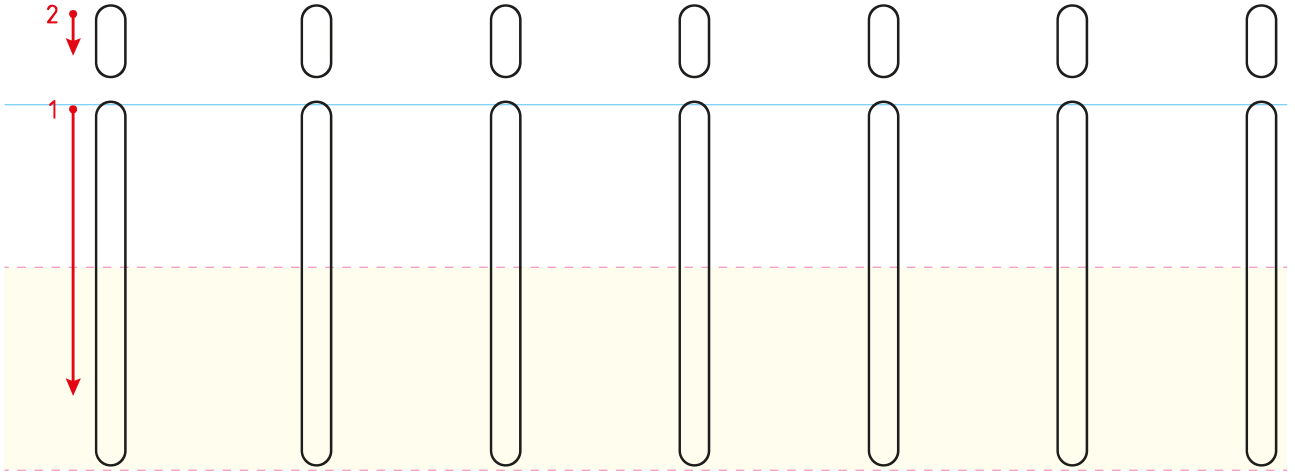



☞ "İ" harfini yazalım.

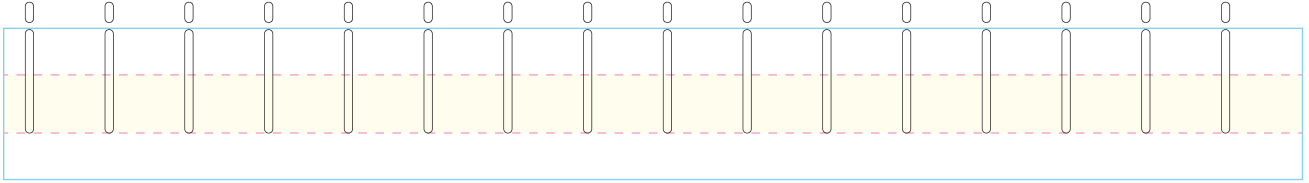



☞ Küçük "i" harfinin yazılış yönüne dikkat edelim. İçinden kalemimizle geçelim.

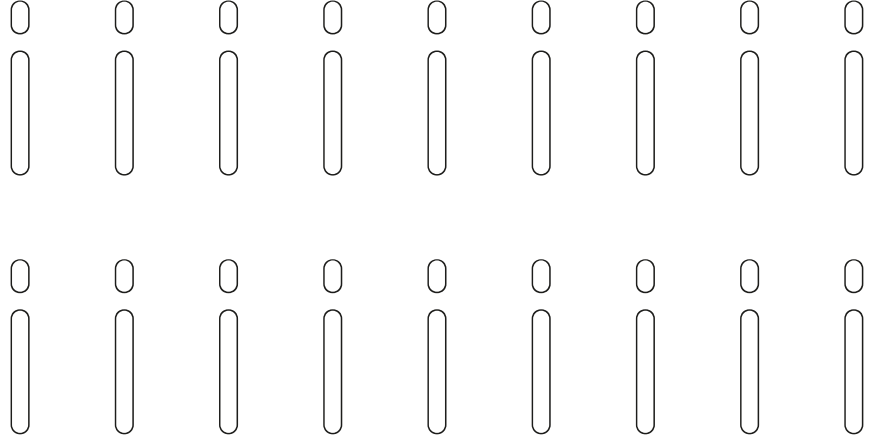
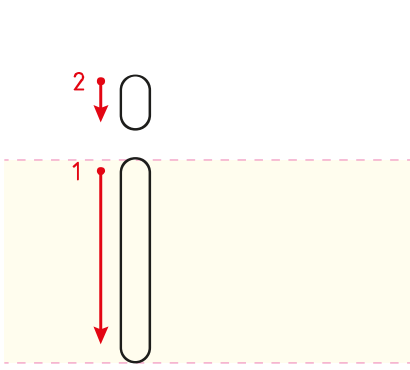

☞ "i" harfinin yazılı olduğu yıldızları boyayalım.



Yönergeleri uygulayalım.

- "i" harfini boyayalım.



- "i" harflerini bulup yuvarlak içine alalım.

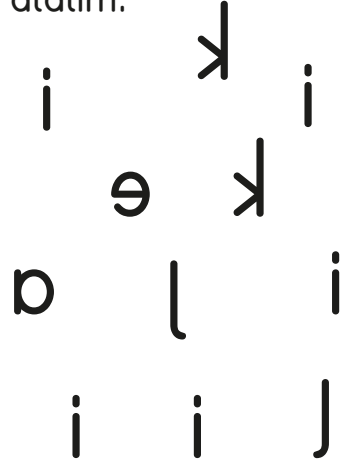

- Noktaları birleştirelim.

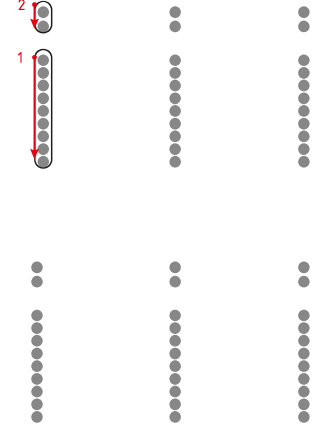

Yazma yönlerine dikkat ederek "i" harfini yazalım.

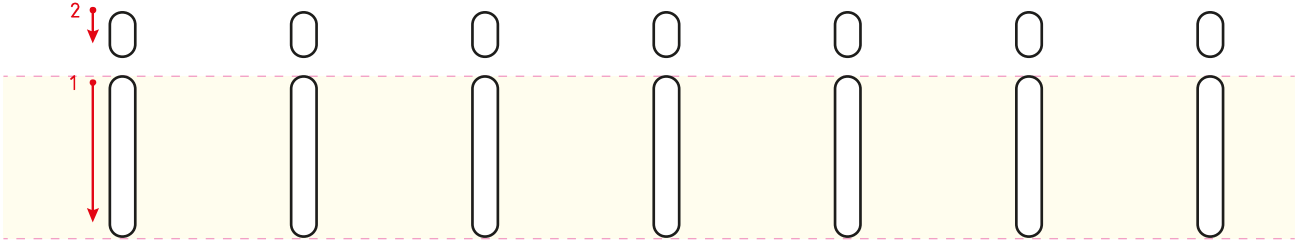



☞ "i" harfini yazalım.

0 0 0 0 0 0 0 0 0 0 0 0 0 0 0

i i i i i i i i

i i i i i i i i

i

i

i

i

i

i

i

i

i

Renklere dikkat ederek görseli boyayalım.

Açık Yeşil i	Koyu Yeşil i	Sarı e	Kırmızı l	Mavi a	Mor k
-----------------	-----------------	-----------	--------------	-----------	----------





👉 Büyük "İ" ve küçük "i" harfini yazalım.

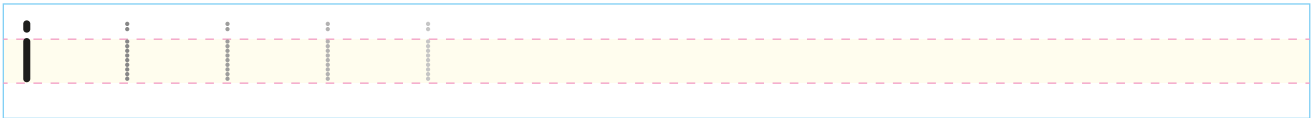
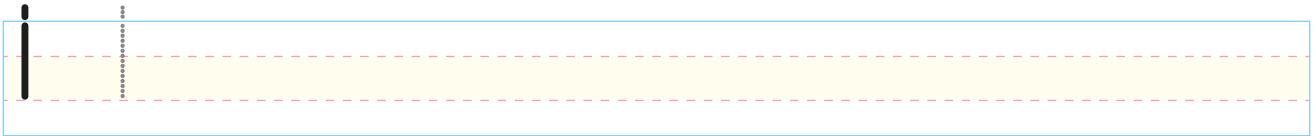
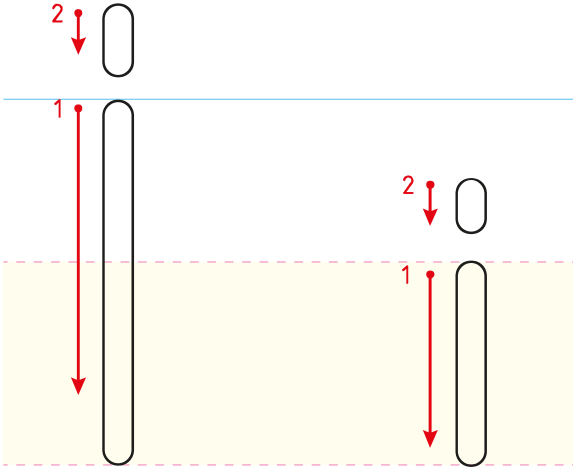



Okuyalım, yazalım.

i l il il il il il il il

il

il

i k ik ik ik ik ik ik

ik

ik

l i li li li li li li

li

li

k i ki ki ki ki ki ki

ki

ki



Okuyalım, yazalım.

i ki iki iki iki iki iki iki

iki

iki

A li Ali Ali Ali Ali

Ali

Ali

Ali kalk.

İki kek al.

Ali al.

Ali iki kek al.

İki kek al.



Okuyalım, yazalım.

el li elli elli elli elli

elli

elli

li la lila lila lila lila

lila

lila

Lila lale al.

Elli lale al.

Ali elli al.

Lila al.

Ali lila al.



Okuyalım, yazalım.

i ki li ikili ikili ikili ikili

ikili

ikili

a i le aile aile aile aile

aile

aile

i lik le ilikle ilikle ilikle ilikle

ilikle

ilikle

Ali ile aile.

Ela ilikle.

Okuyalım, yazalım.

ke kik kek lik

il ke ek li

li la el li

la le li ka le li

e ki li le ke li ke lek li

Okuyalım, görseli boyayalım.

İlke kalk, lale ek.

İki lila lale ek.

Elli lila lale ek.

İlke lila lale ek.





Okuyalım, yazalım.

ALİ İLE İLKE

Ali ile İlke aile.

Ali ile İlke ikili.

Ali ile İlke el ele.

Ali elli lale ekili.

İlke iki lale ekili.



Blank writing area with a dashed line for tracing.

Blank writing area with a dashed line for tracing.

Blank writing area with a dashed line for tracing.

Blank writing area with a dashed line for tracing.

Blank writing area with a dashed line for tracing.

Blank writing area with a dashed line for tracing.



☞ Görseli verilen varlıkların adını yazalım.





☞ Cümleleri doğru kelimelerle tamamlayalım.



İlke _____ lale ek.

İlke ile _____ el ele.

Ali _____ elek al.

İlke _____ lale ek.

Ali ile Ela 1 _____ .



👉 4 rakamını yazalım.

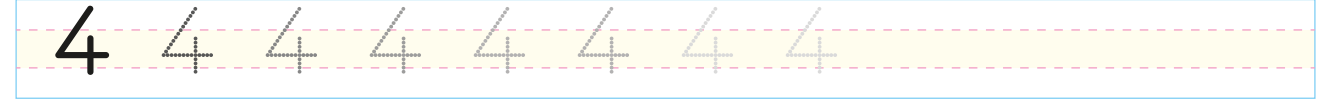
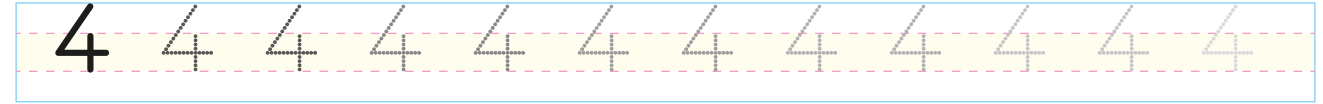
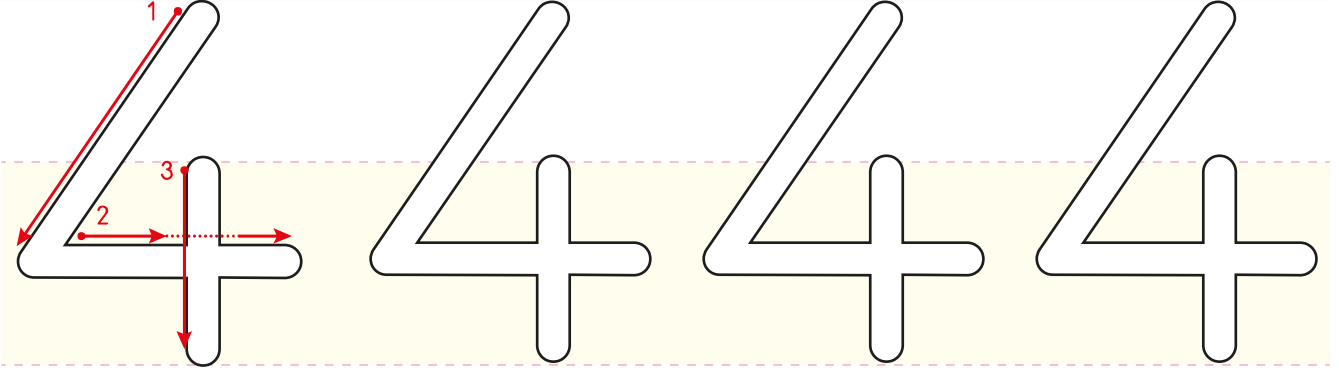

👉 Okuyalım, yazalım.



Ali keki ele al.

Ali keki ele al.

İlke, Ali ile kal.

İlke, Ali ile kal.



Laleli elek ile ele.

Laleli elek ile ele.



☞ Yönergeleri uygulayalım.

- Adı "i" sesi ile başlayan varlıkların görselini sayfanın aşağısındaki görsellerden yapıştıralım.

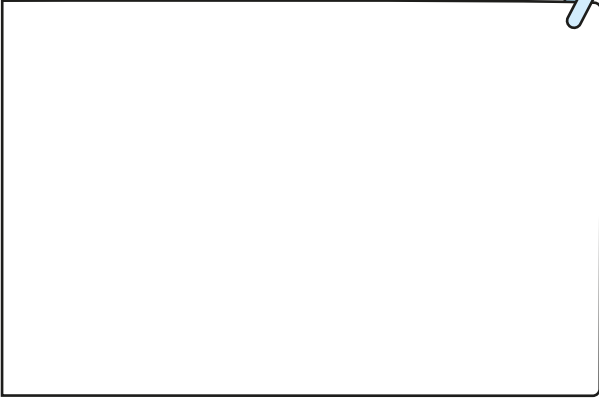

- Adı "i" sesi ile biten varlıkların görselini sayfanın aşağısındaki görsellerden yapıştıralım.

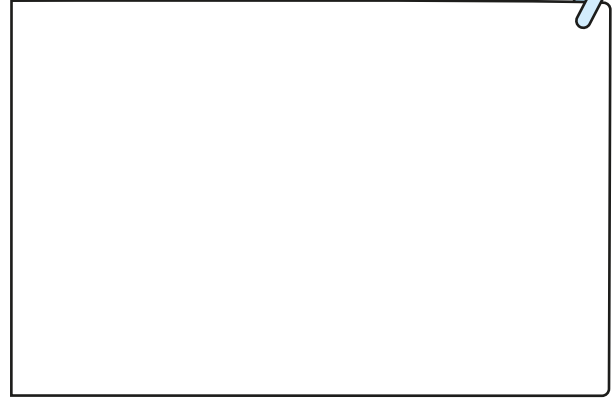

- Adında en çok "i" sesi olan görseli boyayalım.

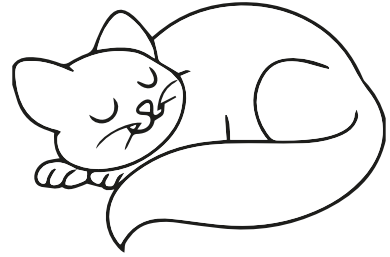
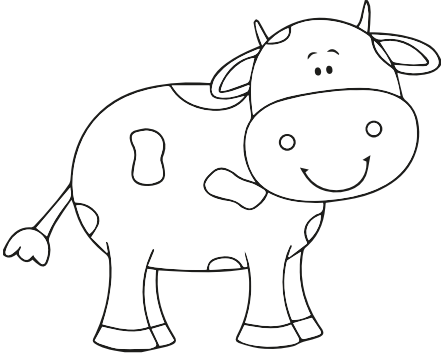

- Büyük "İ" yazalım.

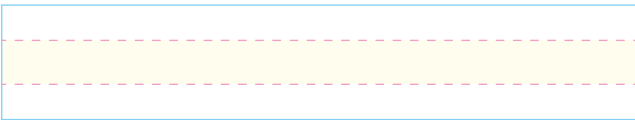
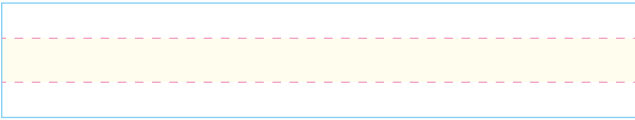

- Küçük "i" yazalım.

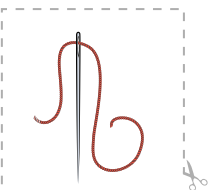
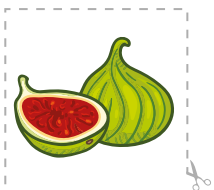

👉 Varlıkların isimlerini söyleyelim. Görselleri boyayalım.



👉 Adında "n" sesi bulunan varlıkları işaretleyelim.

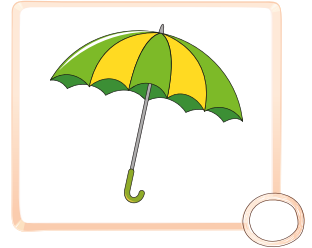
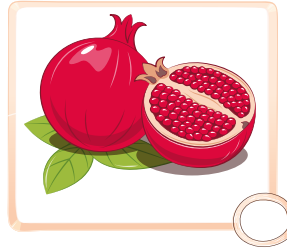
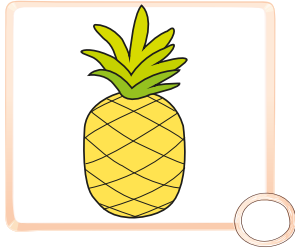
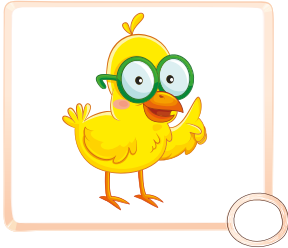
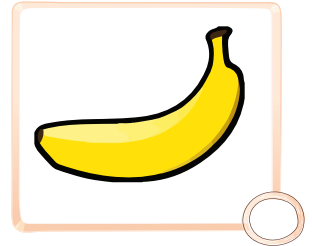
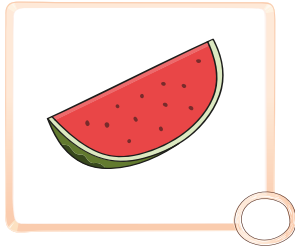
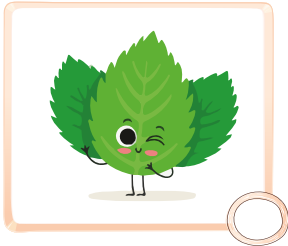
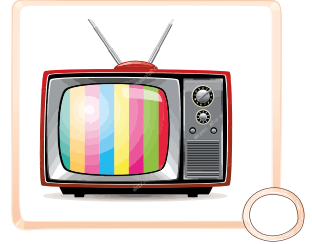
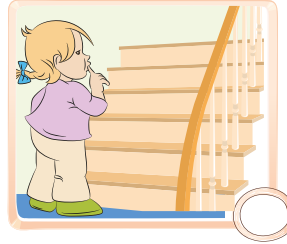
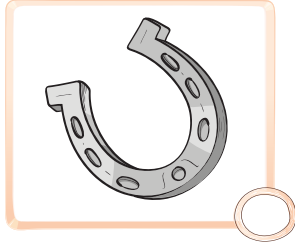

👉 "n" sesi ile biten varlıkları boyyalım.

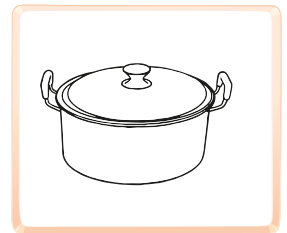
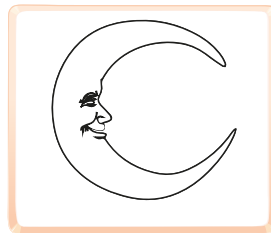
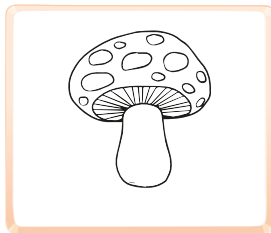
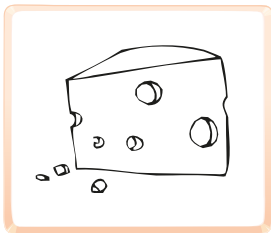
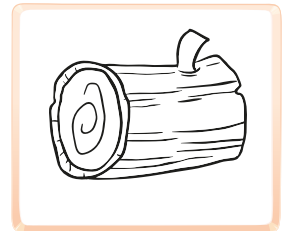
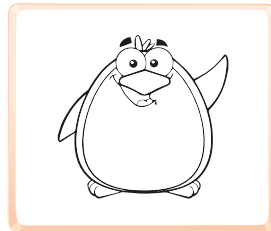
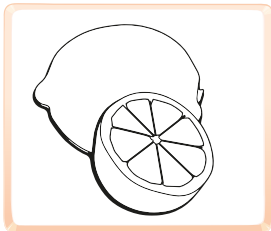
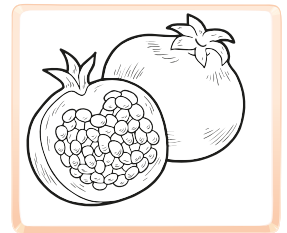
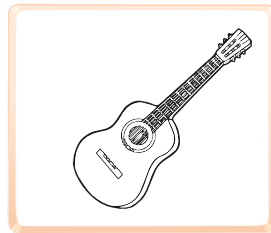
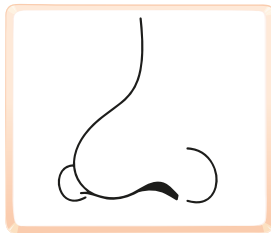
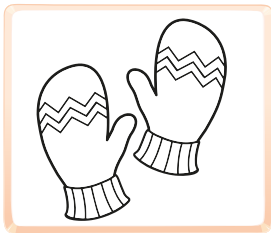

☞ "n" sesi başta ise baştaki, ortada ise ortadaki, sonda ise sondaki şekli işaretleyelim.

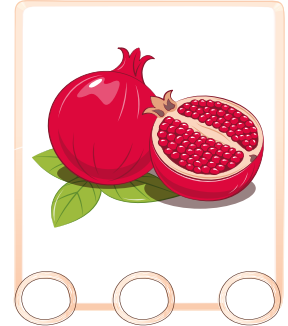
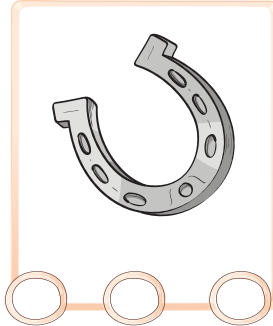
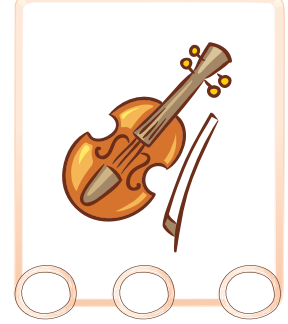
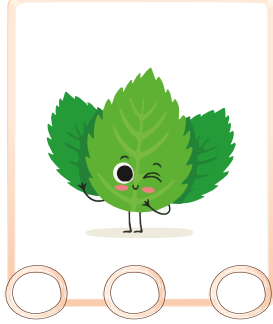

☞ "n" harflerini yuvarlak içine alalım.

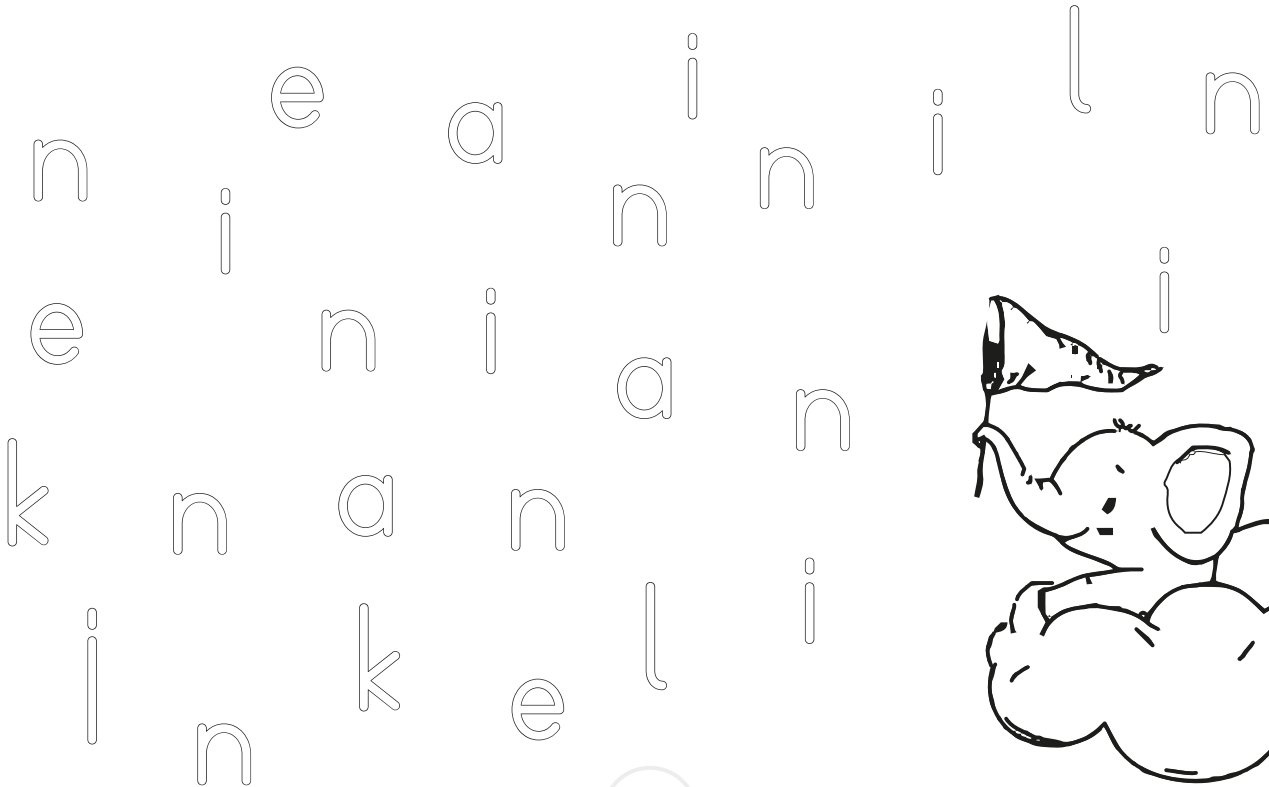



☞ Büyük "N" harfinin yazılış yönüne dikkat edelim. İçinden kalemimizle geçelim.

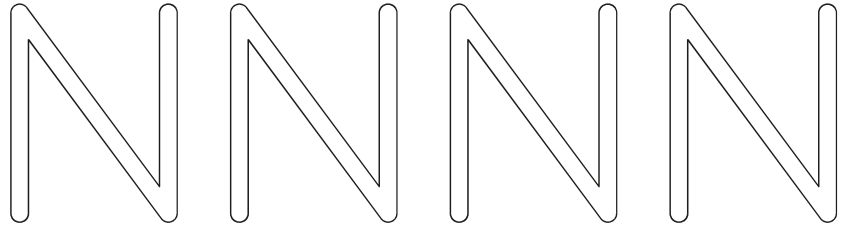
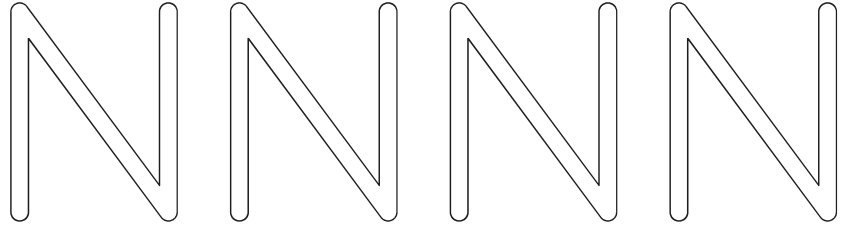
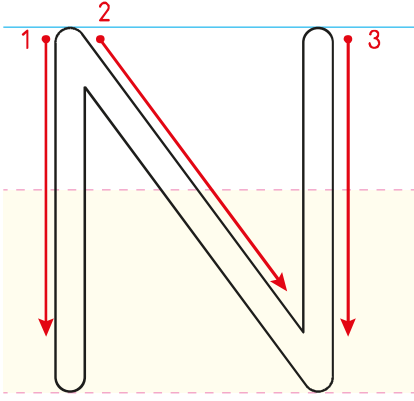

☞ Atı nala ulaştıralım.

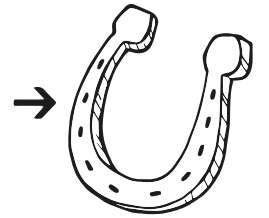
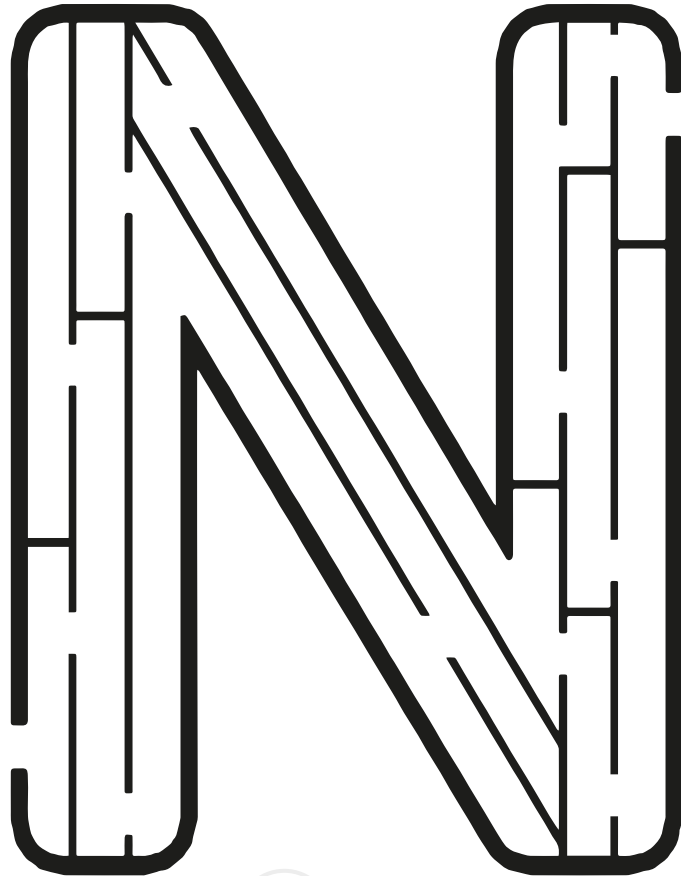
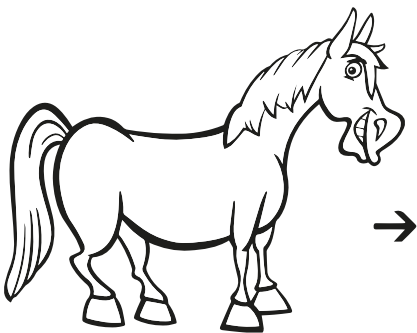

Yönergeleri uygulayalım.

• "N" harfini boyayalım.

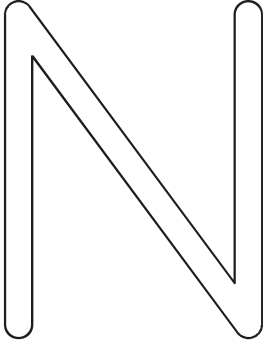

• "N" harflerini bulup yuvarlak içine alalım.

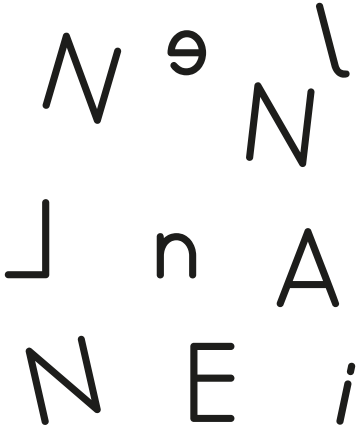

• Noktaları birleştirelim.



Yazma yönlerine dikkat ederek "N" harfini yazalım.

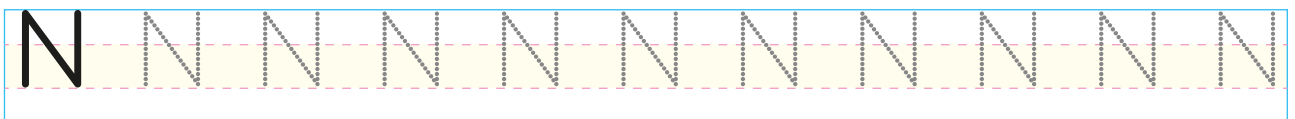
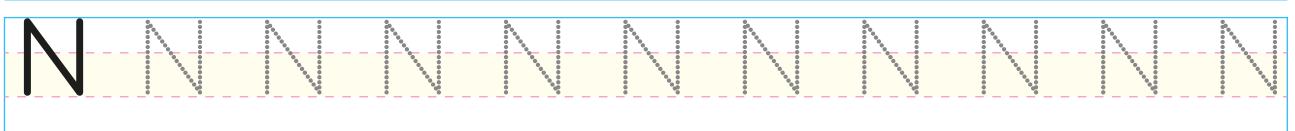
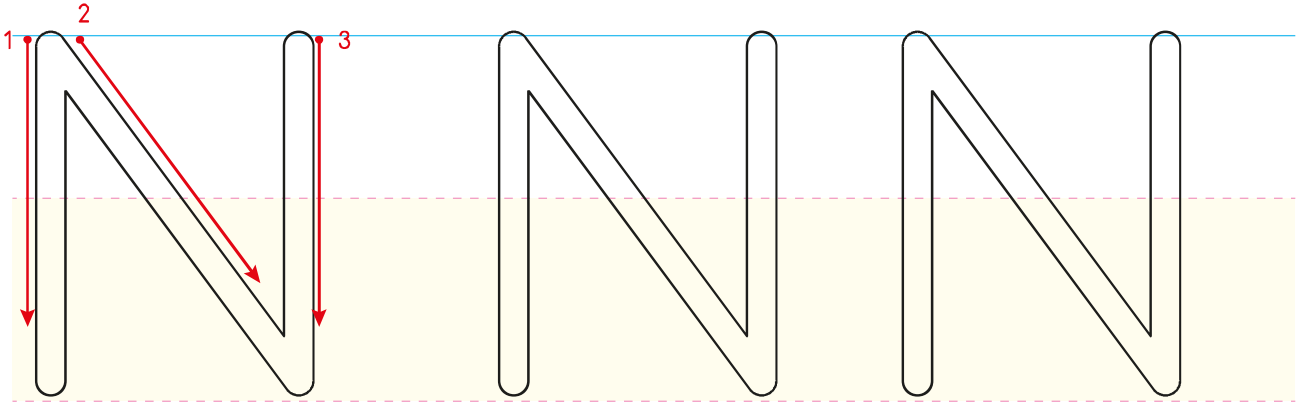



👉 "N" harfini yazalım.

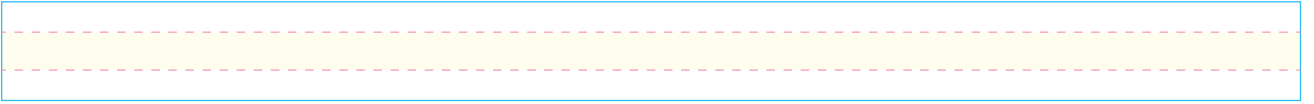
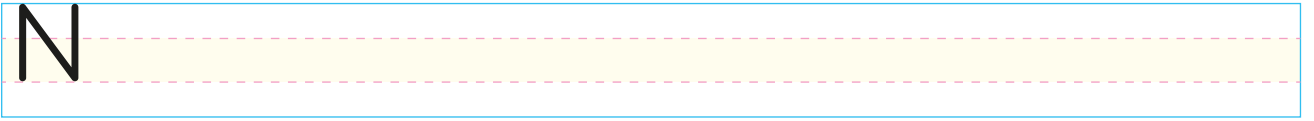
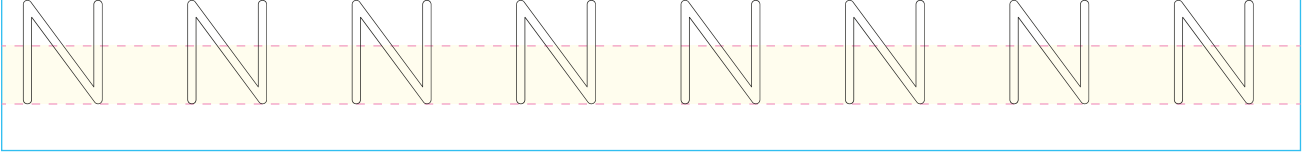



☞ Küçük "n" harfinin yazılış yönüne dikkat edelim. İçinden kalemimizle geçelim.

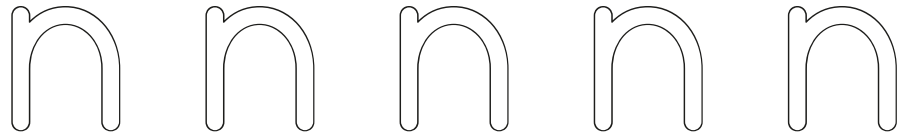
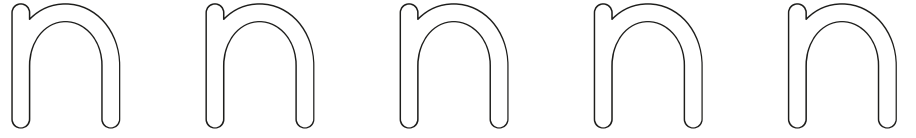
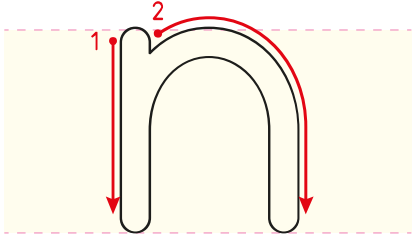

☞ "n" harfinin yazılı olduğu yıldızları boyayalım.



Yönergeleri uygulayalım.

• "n" harfini boyayalım.

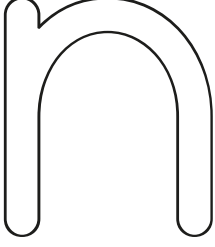

• "n" harflerini bulup yuvarlak içine alalım.

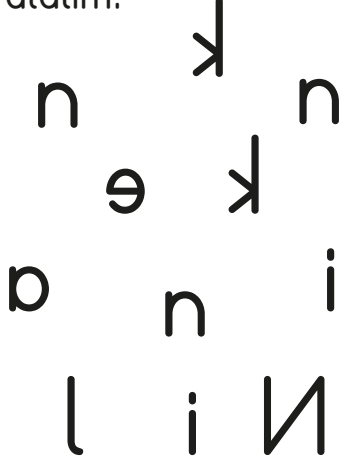

• Noktaları birleştirelim.



Yazma yönlerine dikkat ederek "n" harfini yazalım.

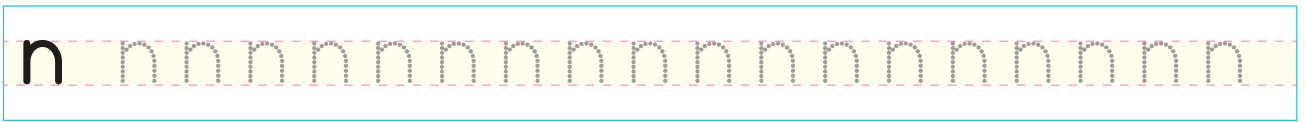
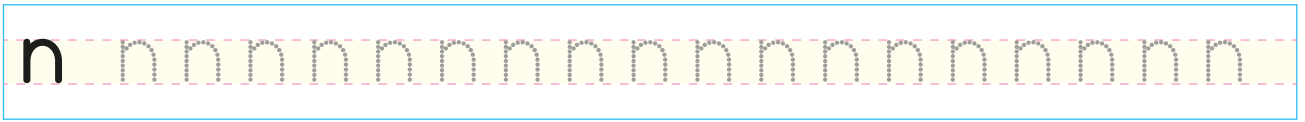
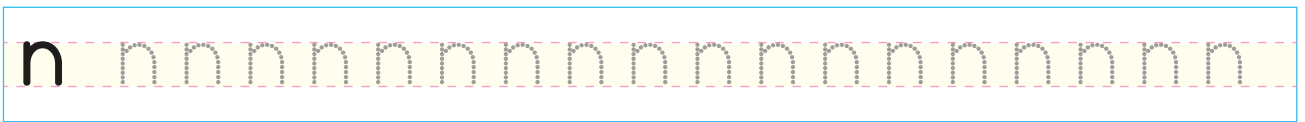
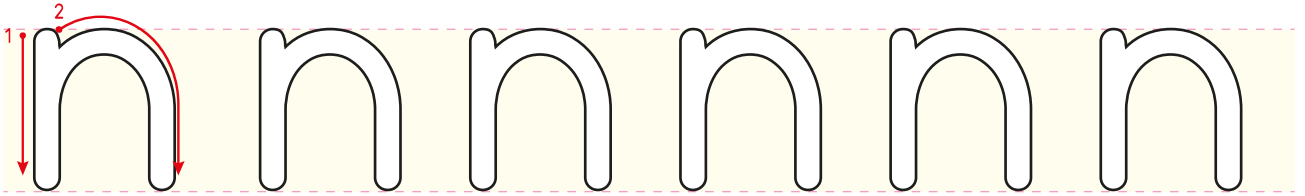



👉 "n" harfini yazalım.

n n n n n n n n n n

n n n n n n n

n n n n n

n

n

Renklere dikkat ederek görseli boyayalım.

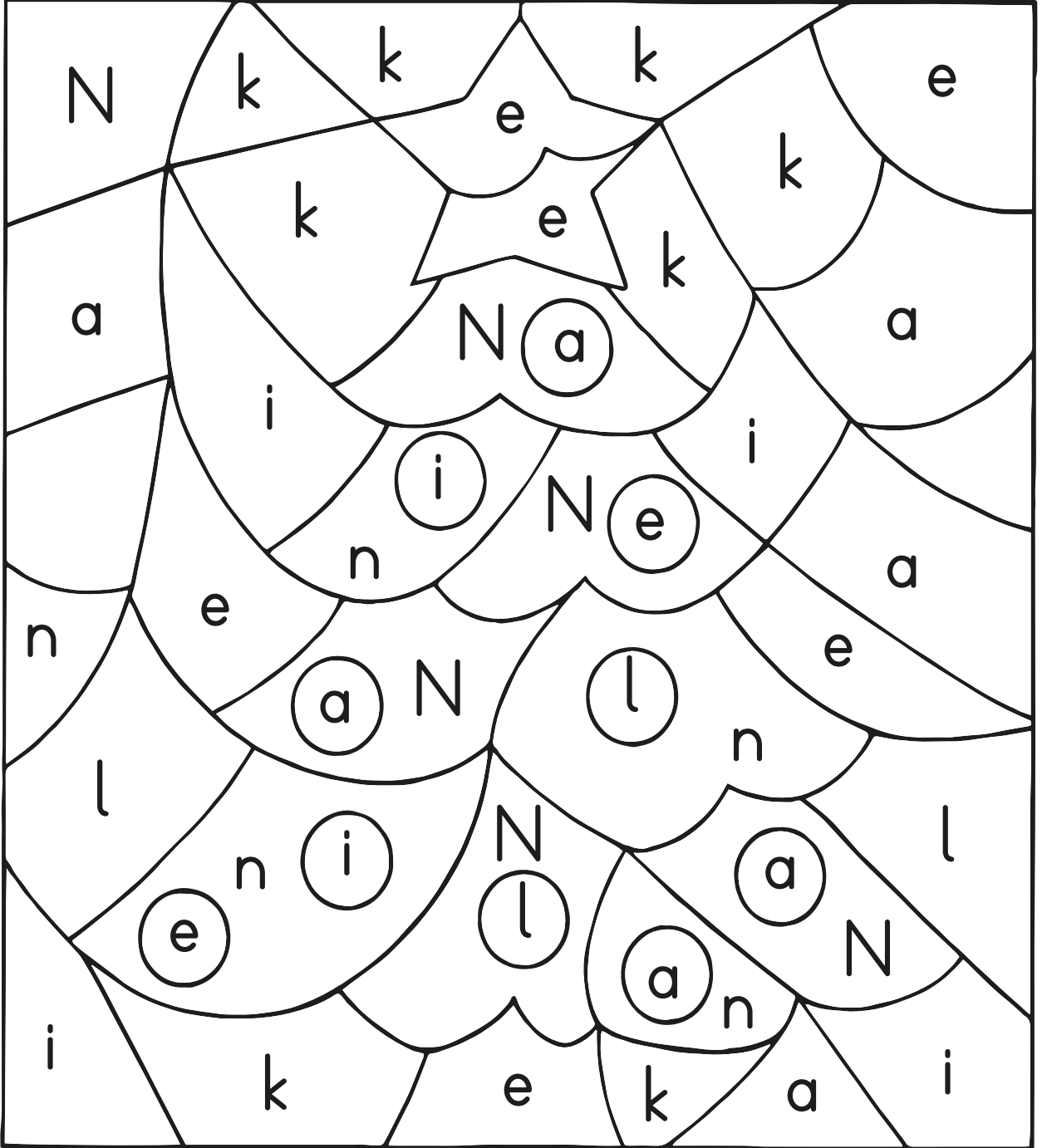
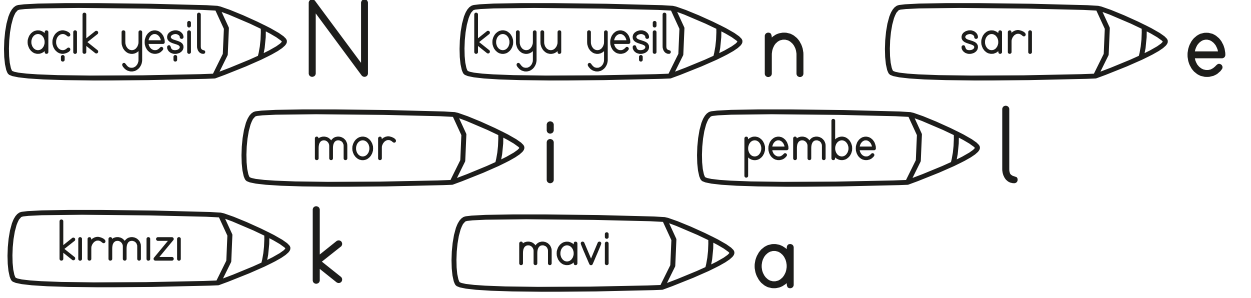



👉 Büyük "N" ve küçük "n" harfini yazalım.

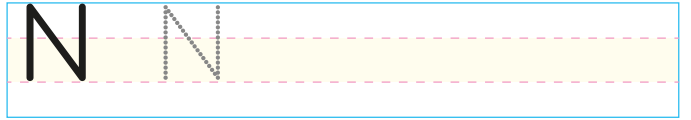
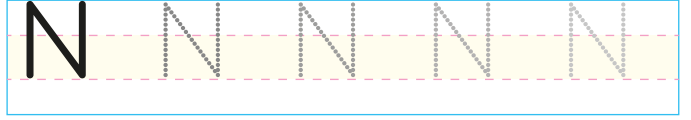
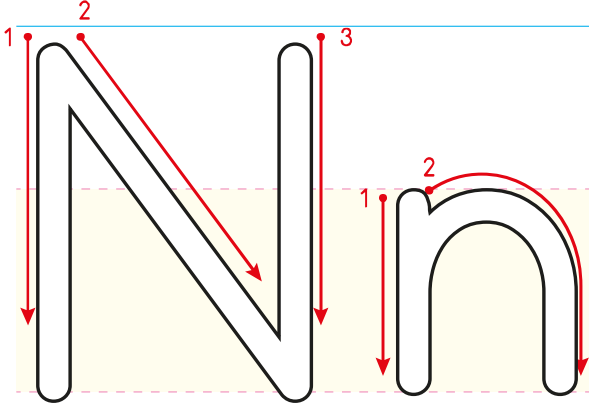

N N

n n n n n

n n n



Okuyalım, yazalım.

e n en en en en en en

en

a n an an an an an an

an

i n in in in in in in

in

en li enli enli enli enli enli

enli

an ne anne anne anne anne

anne

in le inle inle inle inle inle

inle



Okuyalım, yazalım.

n e ne ne ne ne ne ne

ne

n a na na na na na na

na

n i ni ni ni ni ni ni ni

ni

ne ne nene nene nene

nene

na ne nane nane nane nane

nane

ni ne nine nine nine

nine



Okuyalım, yazalım.

Ni l Nil Nil Nil Nil

Nil

na l nal nal nal nal

nal

i nek inek inek inek inek

inek

E kin Ekin Ekin Ekin Ekin

Ekin

Nil eline nal al.

Ninene inek al.

Ekin ile Nil aile.



Okuyalım, yazalım.

Na lan Nalan

Handwriting practice line for the word "Nalan".

Ka an Kaan

Handwriting practice line for the word "Kaan".

Ke nan Kenan

Handwriting practice line for the word "Kenan".

i lan ilan

Handwriting practice line for the word "ilan".

Nalan ilan al.

Kaan ile nal al.

Kenan ile Nalan aile.

Kaan iki nane ek.



Okuyalım, yazalım.

Anne naneli kek al.

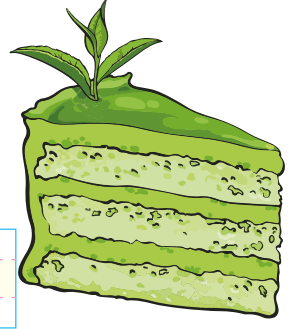

Nail anneni anla.

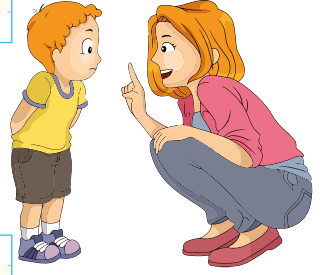

Kaan ala inek elle.



Nil eline iki nane al.

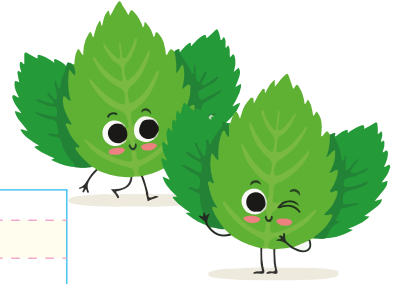

Metni okuyalım. Bir sonraki sayfaya yazalım.

Anne
Anne al.
Anne kek al.
Anne, ninene kek al.
Anne, ninene naneli kek al.
Anne, ninene iki naneli kek al.
Anne, ninene naneli kek al.
Anne, ninene kek al.
Anne kek al.
Anne al.
Anne.

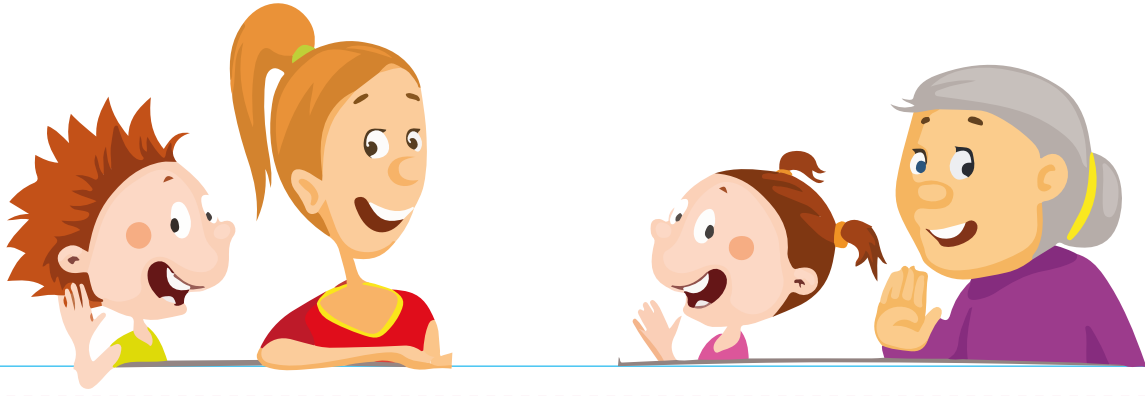

Handwriting practice area consisting of ten horizontal lines. Each line is a blue-bordered rectangle with a dashed red line in the center, providing a guide for letter height and placement.



👉 5 rakamını yazalım.

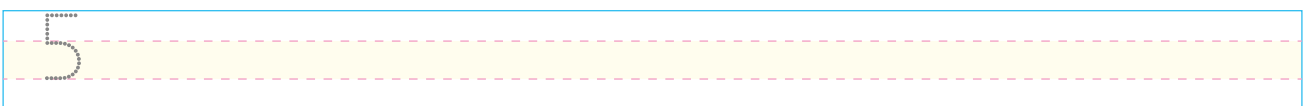
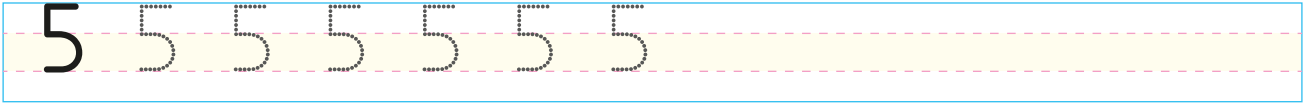
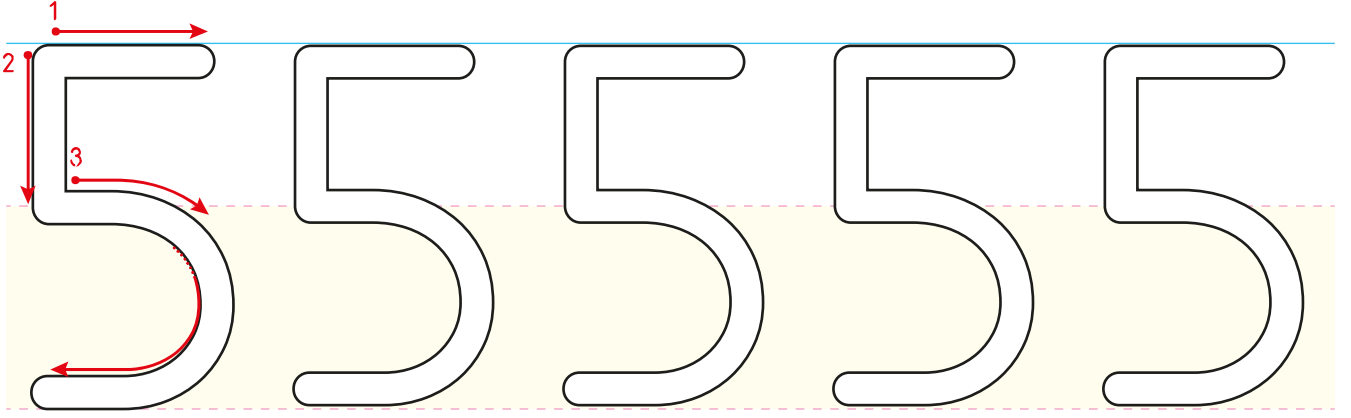

☞ Kelimeleri uygun görsellerin altına yazalım.

anne

nine

nane

Nil

an

anla

en

neli

ninni

kan

inek

kanal



Blank space for writing the word corresponding to the first image.

Blank space for writing the word corresponding to the second image.

Blank space for writing the word corresponding to the third image.

Blank space for writing the word corresponding to the fourth image.

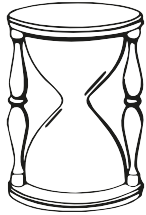

Blank space for writing the word corresponding to the fifth image.

Blank space for writing the word corresponding to the sixth image.

Blank space for writing the word corresponding to the seventh image.

Blank space for writing the word corresponding to the eighth image.

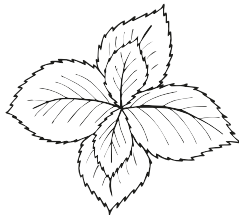
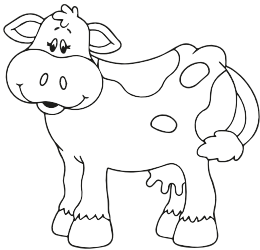

Blank space for writing the word corresponding to the ninth image.

Blank space for writing the word corresponding to the tenth image.

Blank space for writing the word corresponding to the eleventh image.

Blank space for writing the word corresponding to the twelfth image.

👉 Okuyalım, görseli boyayalım.

Nalan ile Nil aile.

Nalan nine.

Nil anne.

Nalan Nil'e lale al.

Nil Nalan'a kek al.

Nil kek neli?

Nalan kek naneli.



👉 Eksik heceleri tamamlayıp yazalım.

na		li	➤	naneli		ne	ne	➤	
a	la		➤		e		ne	➤	
ni		ne	➤		ke	ki		➤	

Yönergeleri uygulayalım.

- Adı "n" sesi ile başlayan varlıkların görselini sayfanın aşağısındaki görsellerden yapıştıralım.

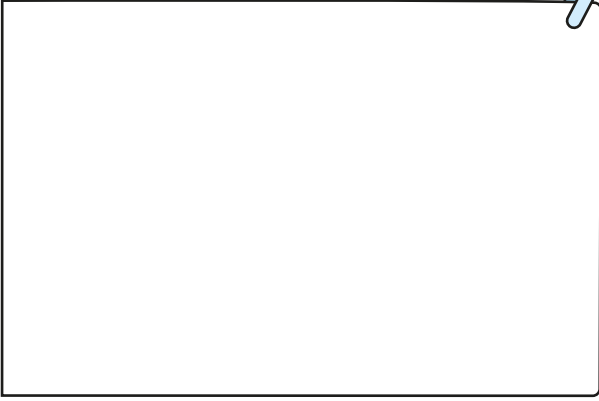

- Adı "n" sesi ile biten varlıkların görselini sayfanın aşağısındaki görsellerden yapıştıralım.

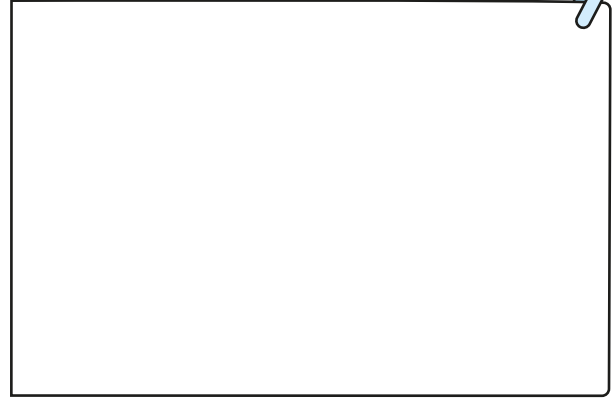

- Adında en çok "n" sesi olan görseli boyyalım.

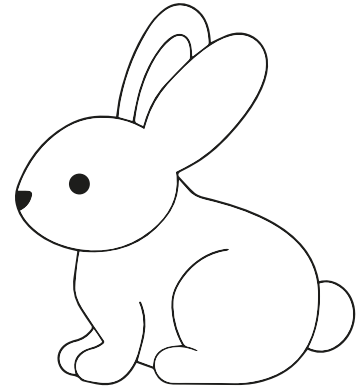
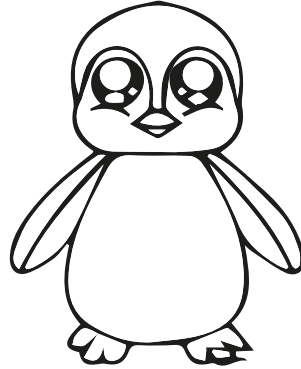
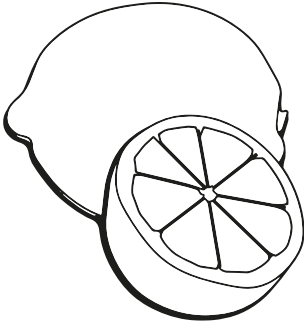

- Büyük "N" yazalım.

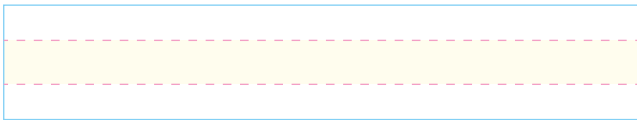
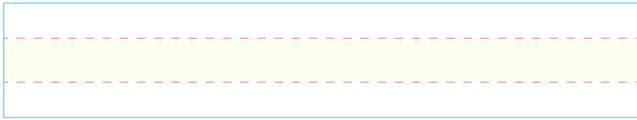

- Küçük "n" yazalım.

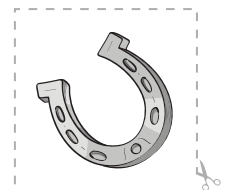
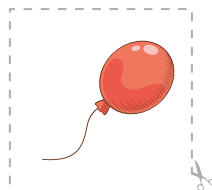
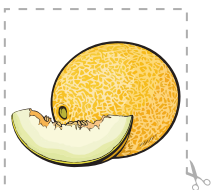
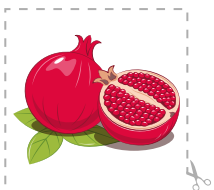
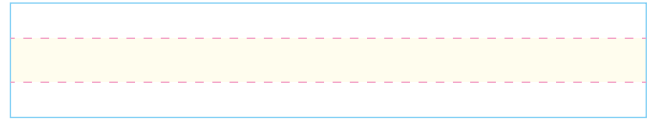

MATEMATİK

1

2

3

4

5

6

7

8

+

-

9

0

÷

×

=

?



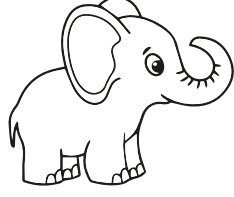
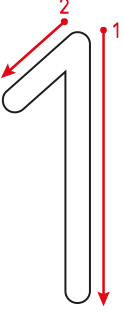

1 1 1 1

1 elma boyayalım.

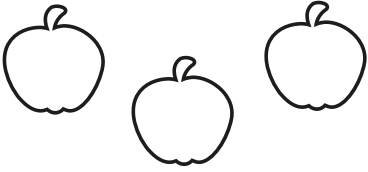

1 top çizelim.

1 tane "N" yazalım.

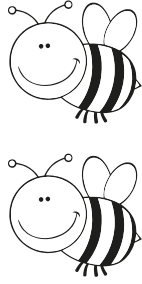
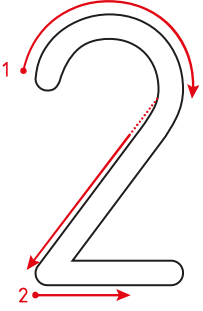

2 2 2 2

2 erik boyayalım.

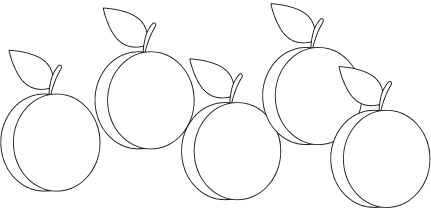

2 kalem çizelim.

2 tane "i" yazalım.

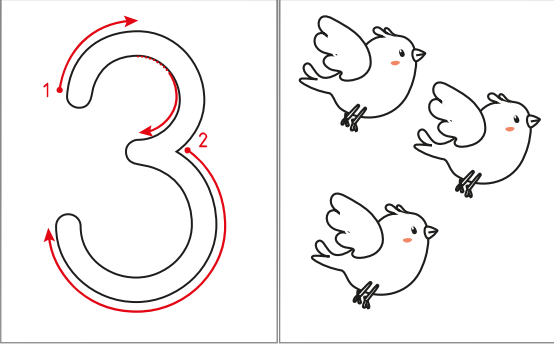

3 3 3 3

Blank handwriting practice lines for the number 3.

Blank handwriting practice lines.

3 ev boyayalım.



3 kalp çizelim.

3 tane "L" yazalım.

Blank handwriting practice lines for the letter L.

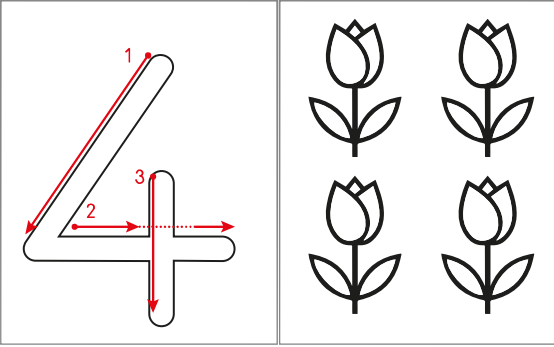

4 4 4 4

Blank handwriting practice lines for the number 4.

Blank handwriting practice lines.

4 armut boyayalım.

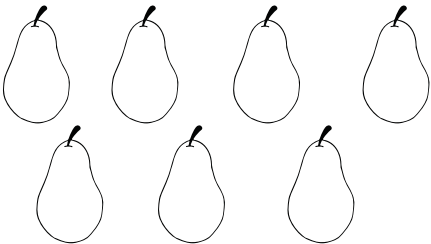

4 yıldız çizelim.

4 tane "E" yazalım.

Blank handwriting practice lines for the letter E.

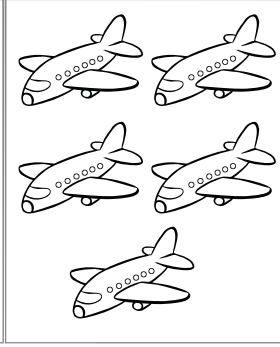
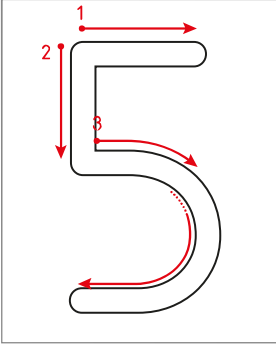

5 5 5 5

Blank handwriting practice lines for the number 5.

Blank handwriting practice lines.

5 çilek boyayalım.

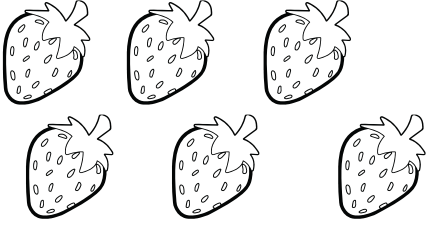

5 ay çizelim.

5 tane "A" yazalım.

Blank handwriting practice lines for writing the letter 'A'.

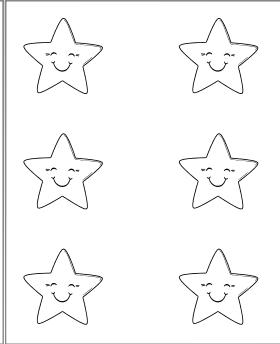
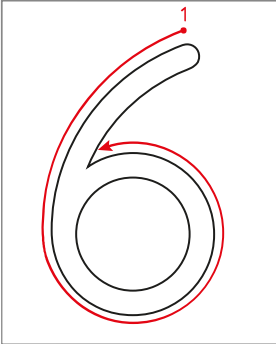

6 6 6 6

Blank handwriting practice lines for the number 6.

Blank handwriting practice lines.

6 defter boyayalım.

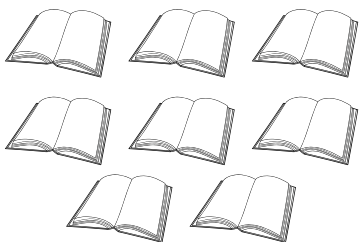

6 güneş çizelim.

6 tane "K" yazalım.

Blank handwriting practice lines for writing the letter 'K'.

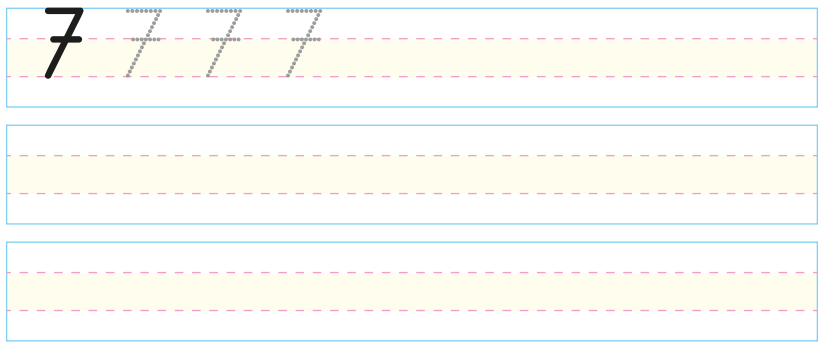
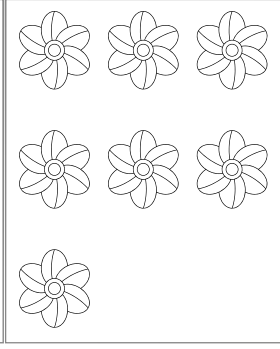
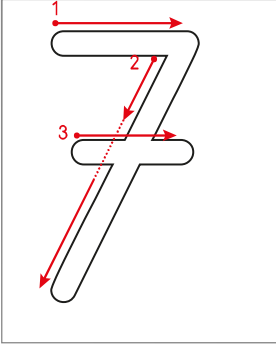

7 kedi boyyalım.

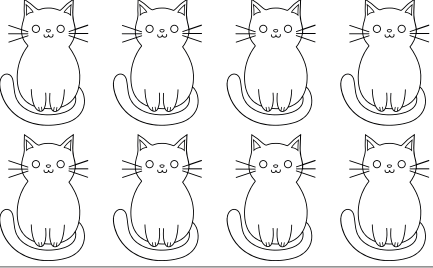

7 portakal çizelim.

7 tane "N" yazalım.

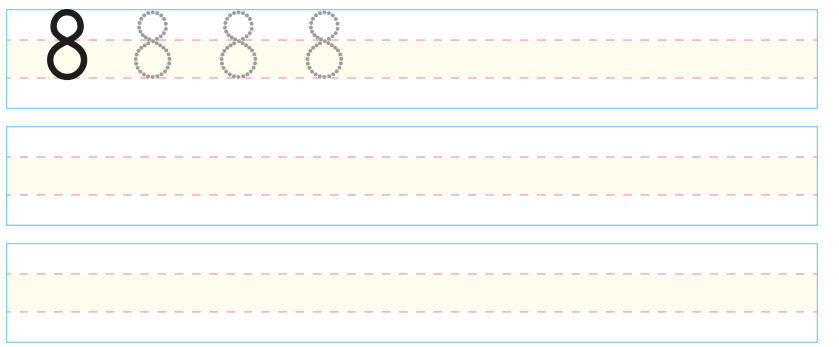
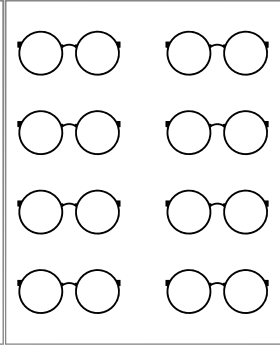
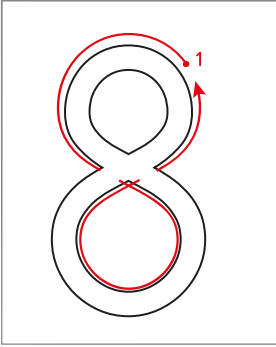
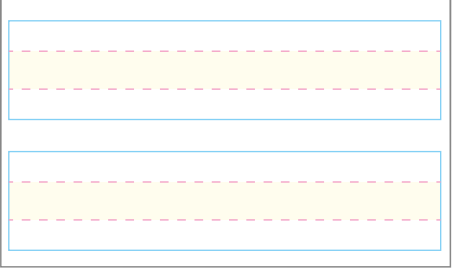

8 çanta boyyalım.



8 çiçek çizelim.

8 tane "İ" yazalım.

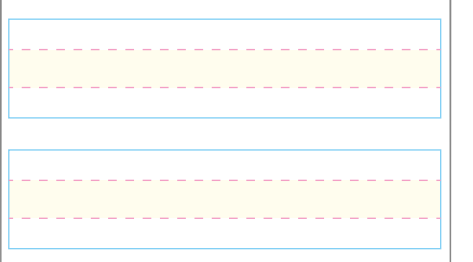

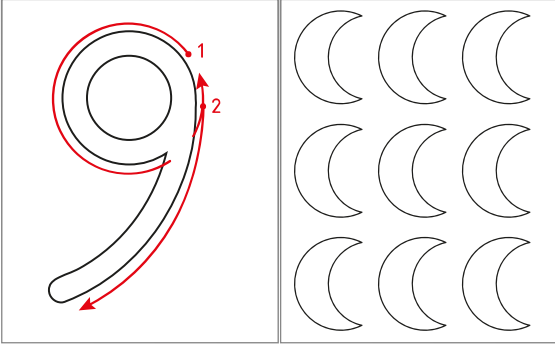

9 9 9 9

Blank handwriting lines for practicing the number 9.

Blank handwriting lines for practicing the number 9.

9 çiçek boyayalım.

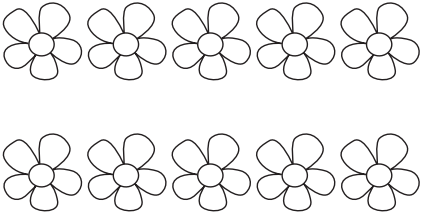

9 muz çizelim.

9 tane "L" yazalım.

Blank handwriting lines for practicing the letter L.

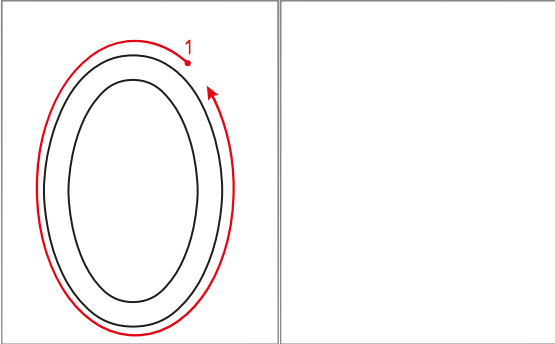

0 0 0 0

Blank handwriting lines for practicing the number 0.

Blank handwriting lines for practicing the number 0.

0 gül boyayalım.

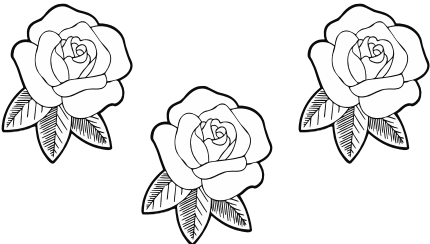

0 çocuk çizelim.

0 tane "E" yazalım.

Blank handwriting lines for practicing the letter E.

👉 Varlıkların sayısını yazalım.

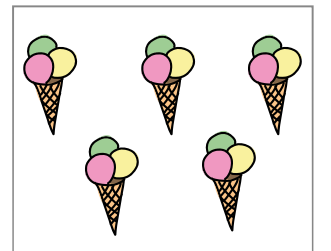
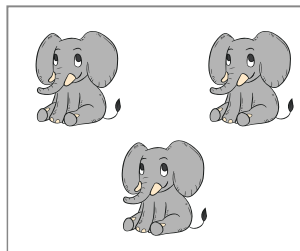
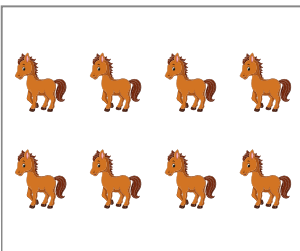
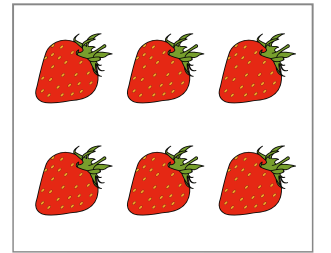
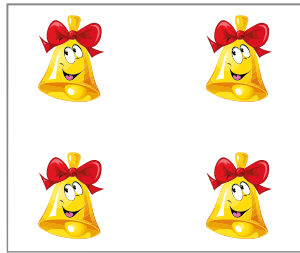
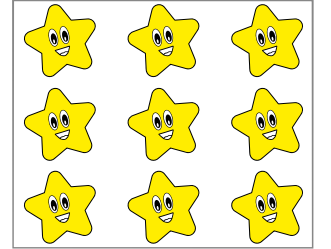
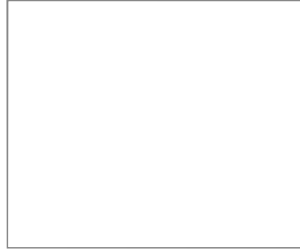
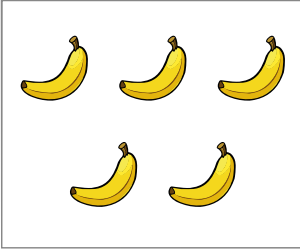
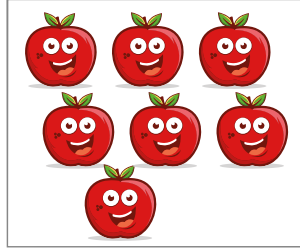
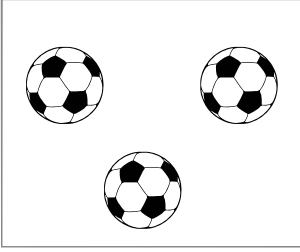

👉 Aşağıdaki varlıkları nesne sayılarıyla eşleştirelim.

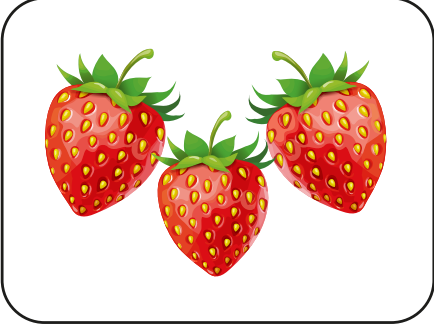

5

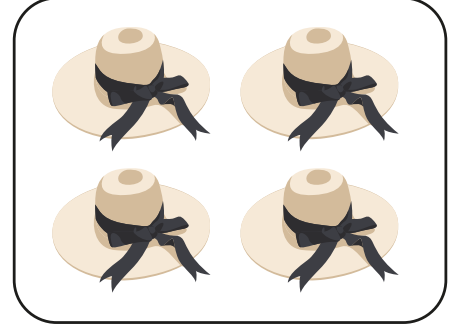

8

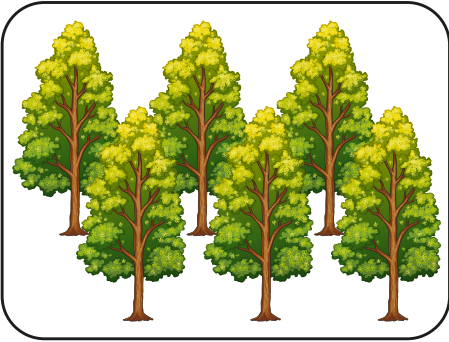

3

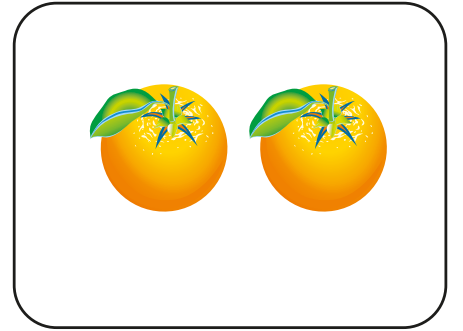

1



4

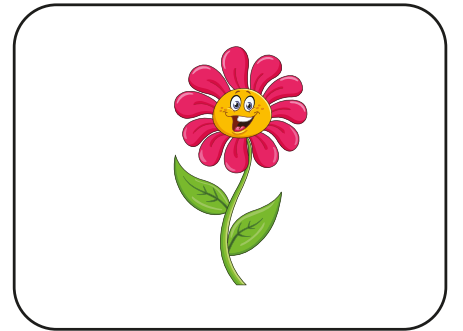

7

6

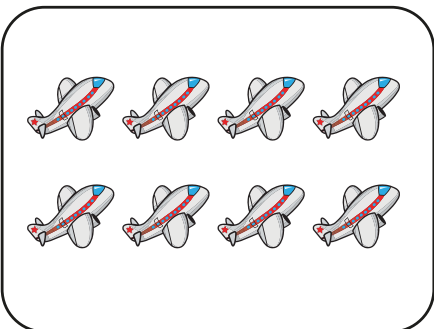

2

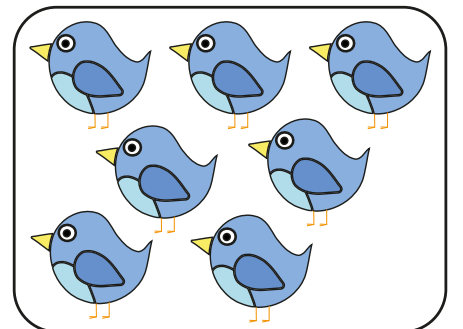

7

Varlıkların sayısını yazalım.

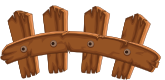
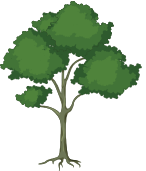

Varlıkların sayısını yazalım.

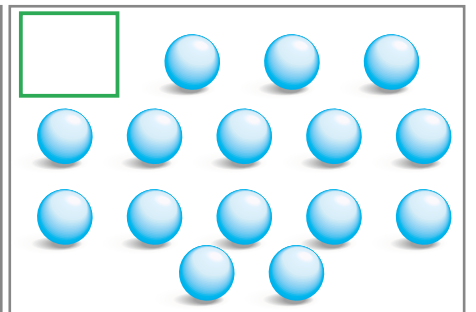
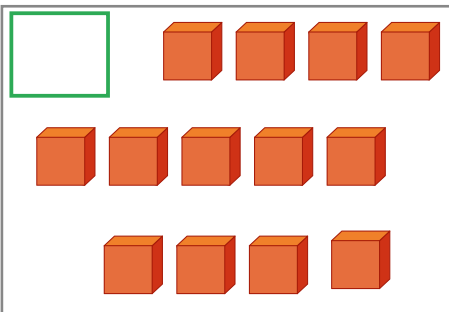
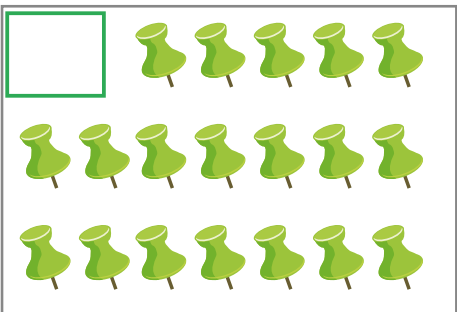
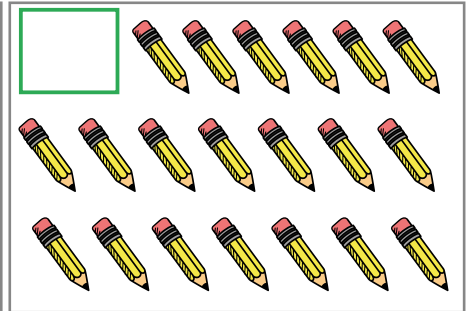
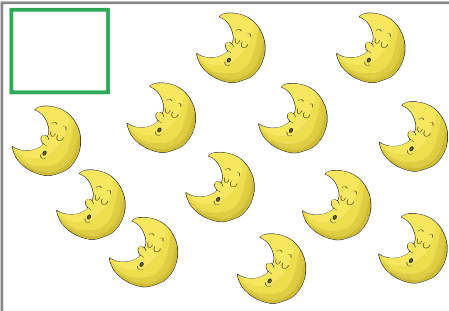
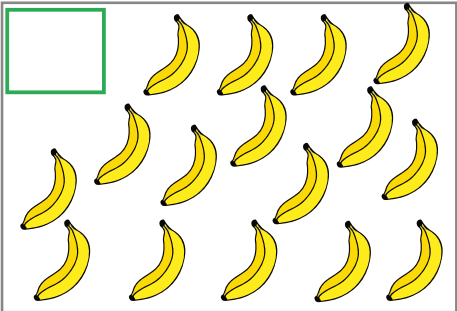
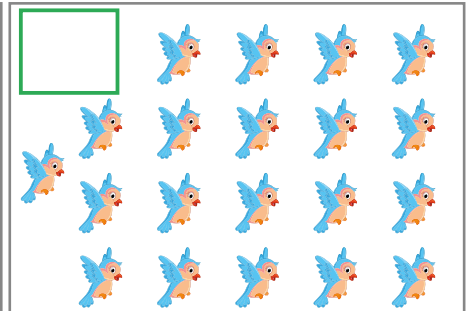
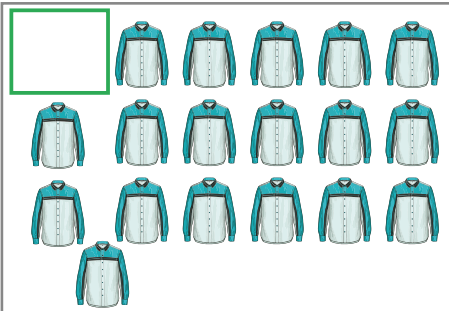
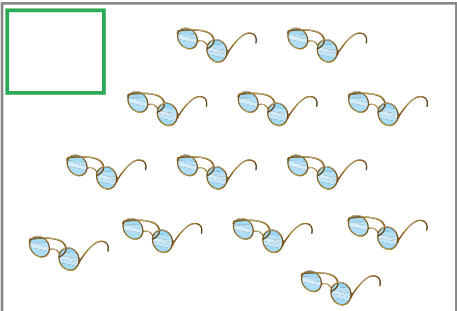
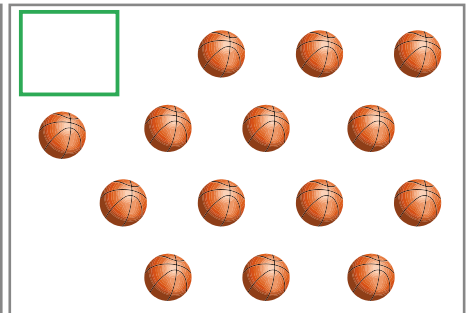
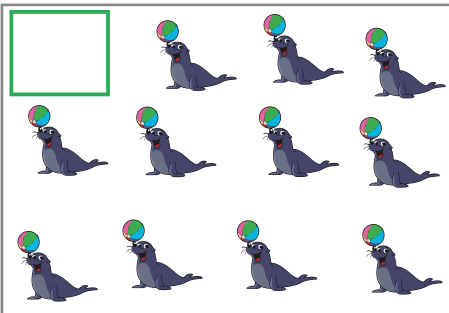
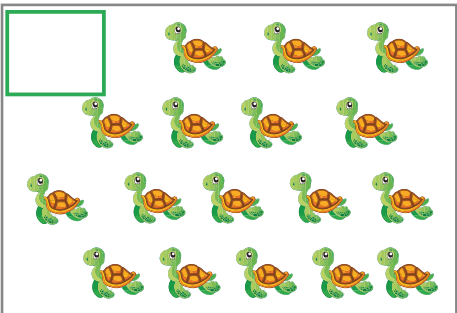
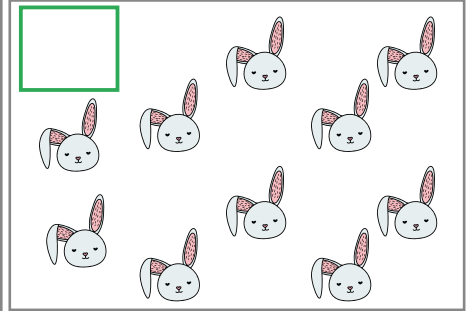
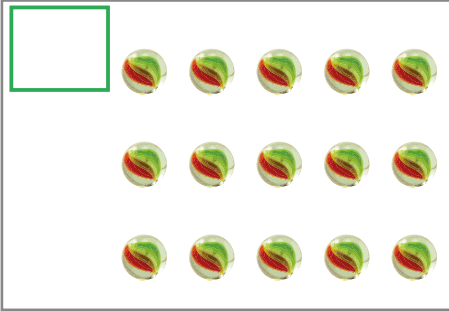
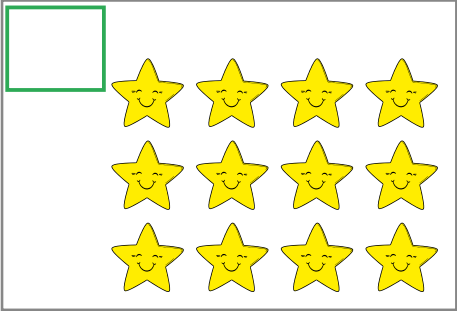



👉 Verilen sayı kadar şekil çizelim.

13 	15	12
10	7	14
20	8	16
6	11	9
14	5	17

👉 Aşağıda verilen sayılardan önce ve sonra gelen sayıları noktalı yerlere yazalım.

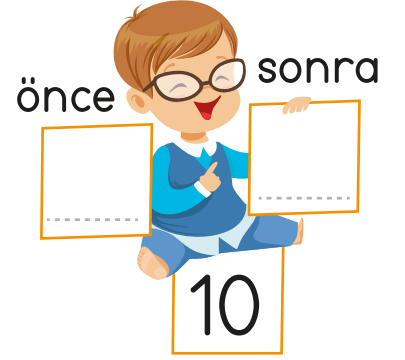
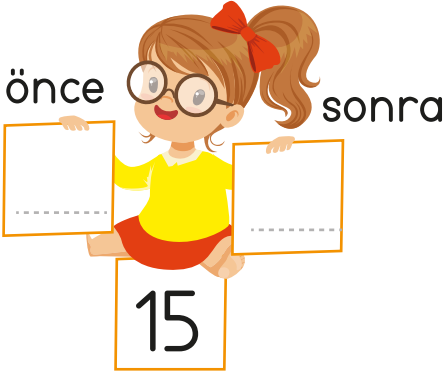
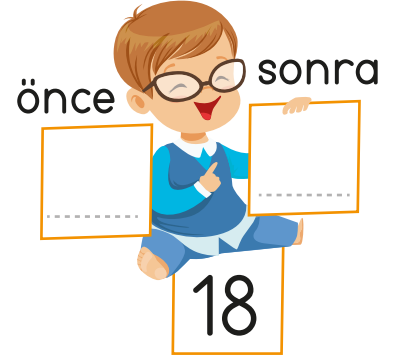
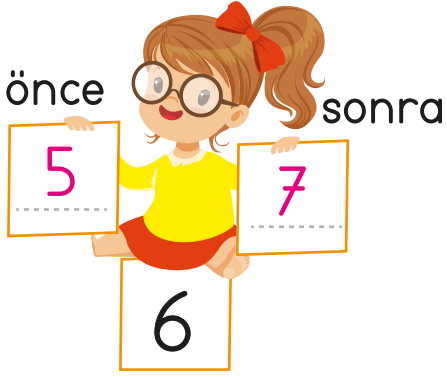

👉 Fincanlardaki sayıların arasına gelmesi gereken sayıları demliklerin üzerine yazalım.





 Boş kutulara gelecek sayılar yazalım.

	5	
--	---	--

	12	
--	----	--

	9	
--	---	--

2		4
---	--	---

8		10
---	--	----

7		9
---	--	---

	15	
--	----	--

	19	
--	----	--

	6	
--	---	--

1		3
---	--	---

10		12
----	--	----

16		18
----	--	----

	2	
--	---	--

	10	
--	----	--

	14	
--	----	--

9		11
---	--	----

18		20
----	--	----

5		7
---	--	---

	16	
--	----	--

	3	
--	---	--

	8	
--	---	--

11		13
----	--	----

17		19
----	--	----

14		16
----	--	----