



A SESİ ÇALIŞMALARI





👉 Görseli boyayalım. Gördüklerimizi anlatalım.



👉 Adında "a" sesi bulunan varlıkları işaretleyelim.

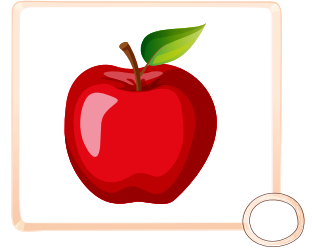
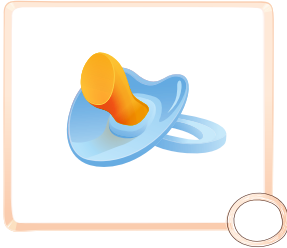
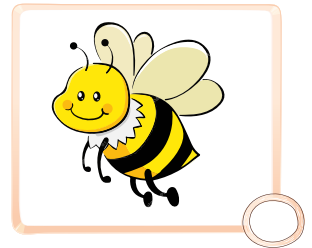
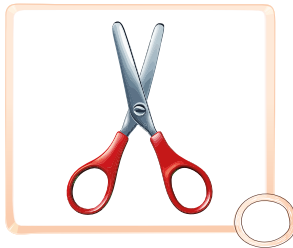
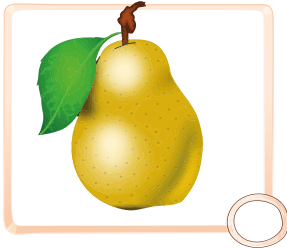
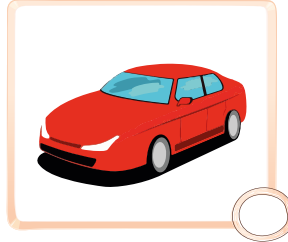
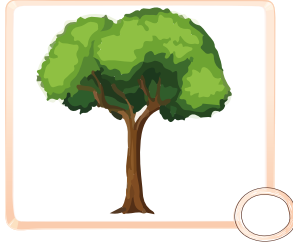

👉 "a" sesi ile başlayan varlıkları boyyalım.

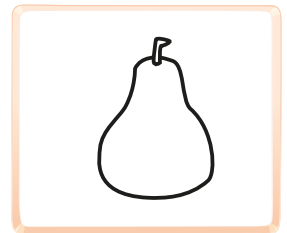
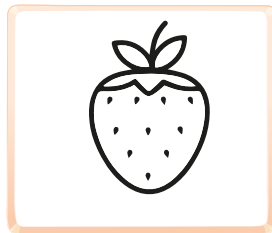
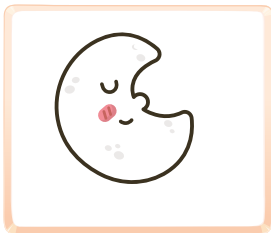
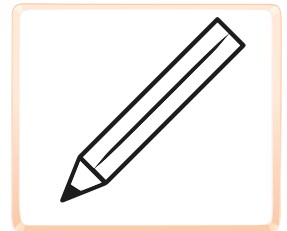
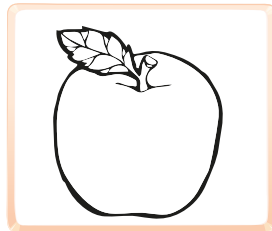
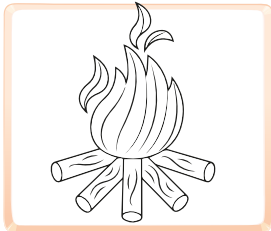
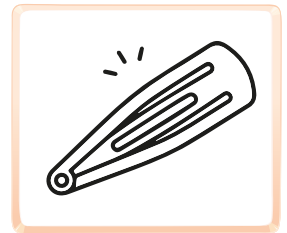
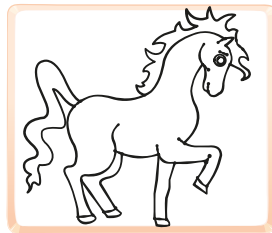
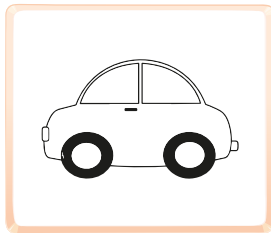

☞ "a" sesi ile biten varlıkları işaretleyelim.

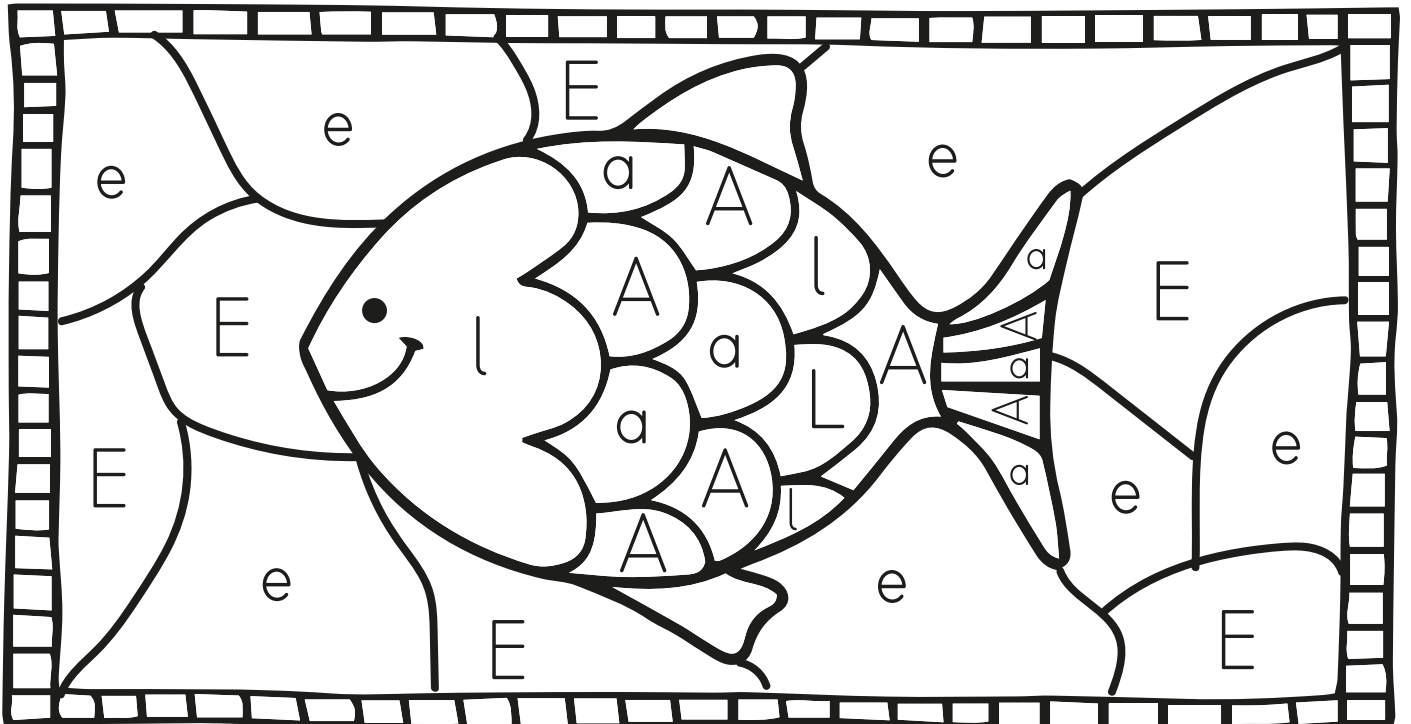

☞ Büyük "A" harfinin yazılış yönüne dikkat edelim. İçinden kalemimizle geçelim.

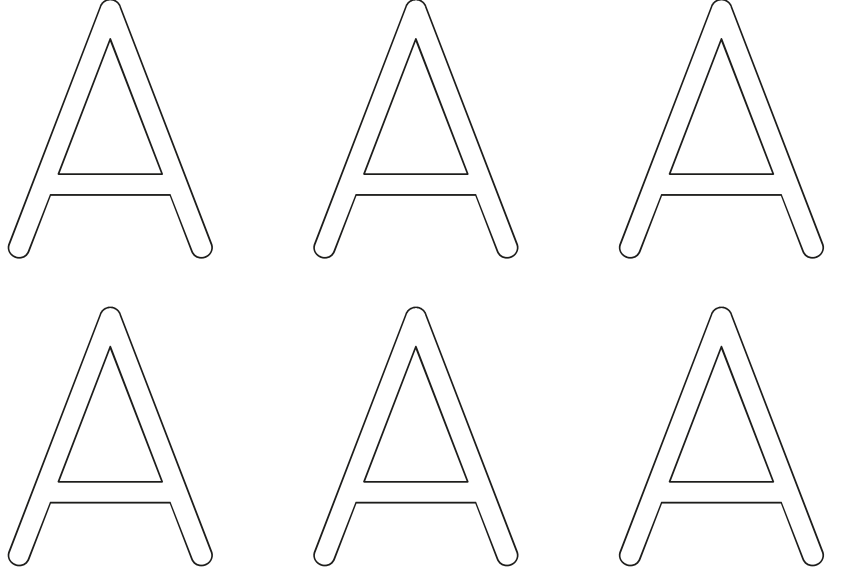
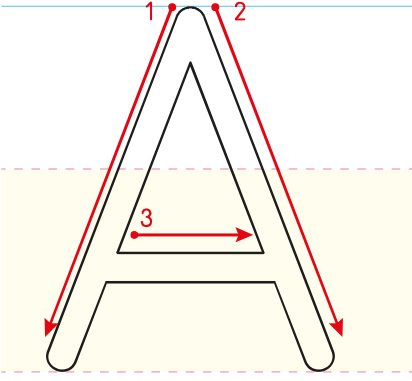

☞ "A" harfinin yazılı olduğu yerleri boyayalım.

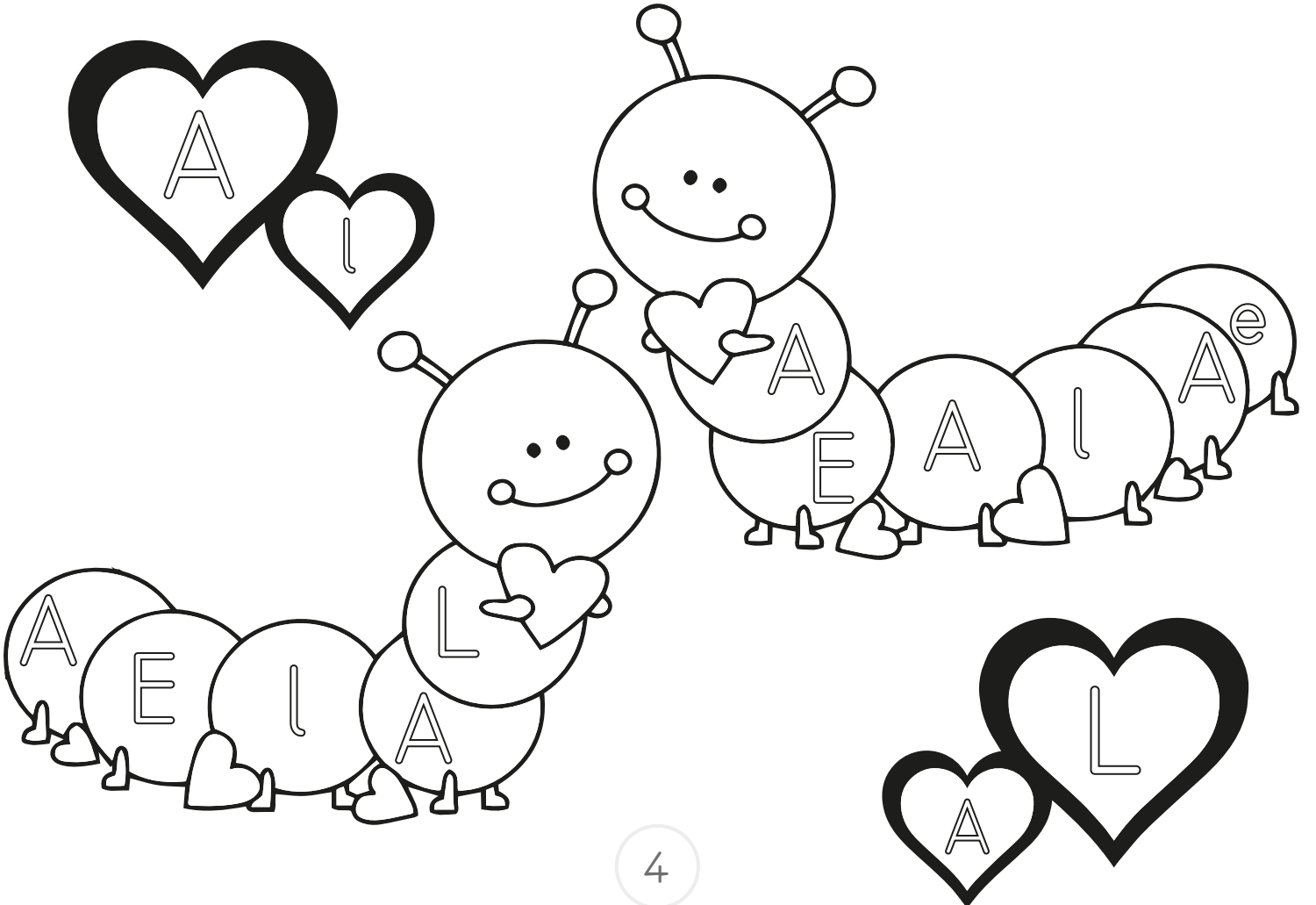

Yönergeleri uygulayalım.

• "A" harfini boyayalım.

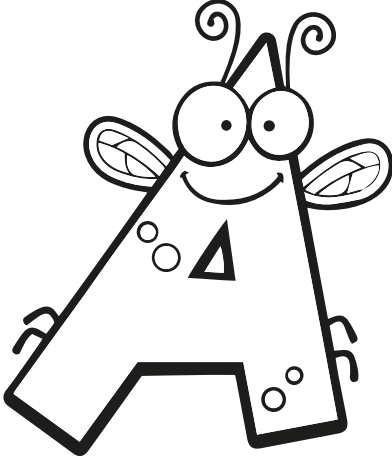

• "A" harflerini bulup yuvarlak içine alalım.

A e l

E A L

A l A

• Noktaları birleştirelim.

A A A

A A A

A A A

Yazma yönlerine dikkat ederek "A" harfini yazalım.

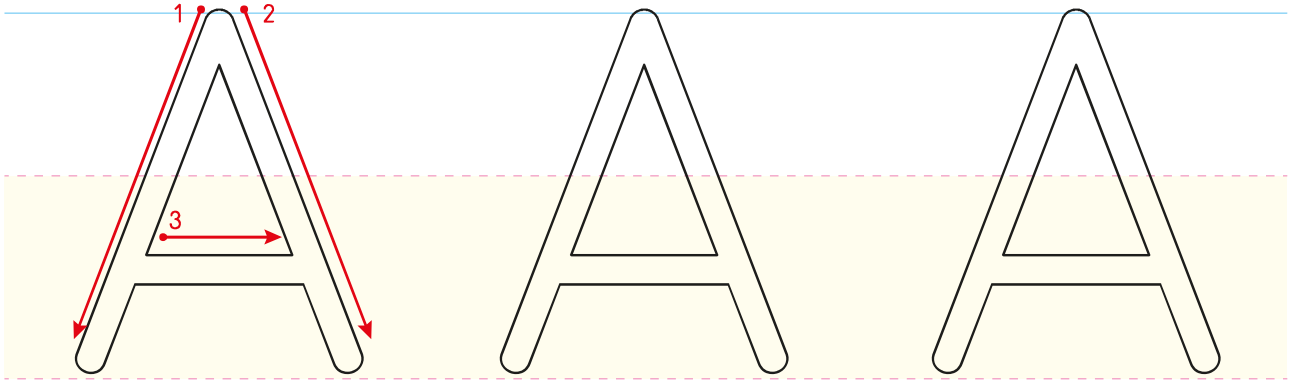

A A A A A A A A A A A

A A A A A A A A A A A



☞ "A" harfini yazalım.

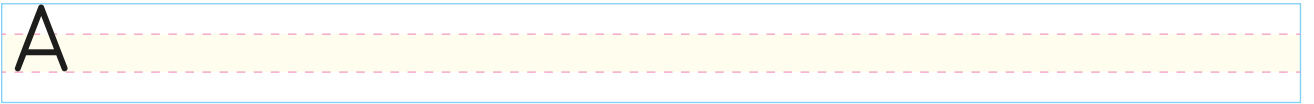
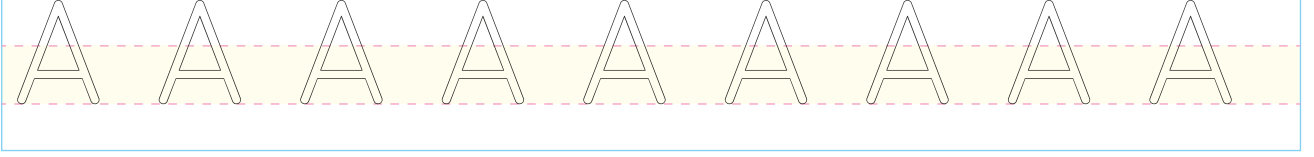



☞ Küçük "a" harfinin yazılış yönüne dikkat edelim. İçinden kalemimizle geçelim.

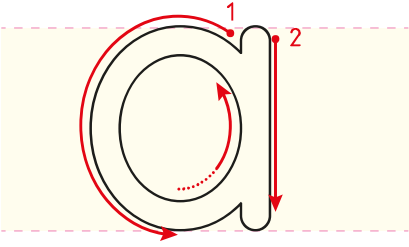

☞ "a" harfinin yazılı olduğu yıldızları boyayalım.



Yönergeleri uygulayalım.

• "a" harfini boyayalım.

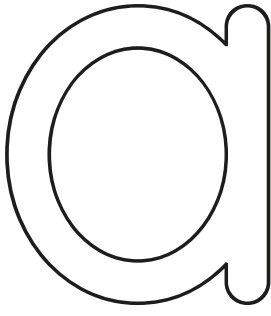

• "a" harflerini bulup yuvarlak içine alalım.

a b a
b b
b a b
a a b

• Noktaları birleştirelim.

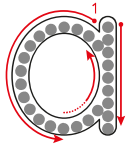

a a a
a a a

Yazma yönlerine dikkat ederek "a" harfini yazalım.

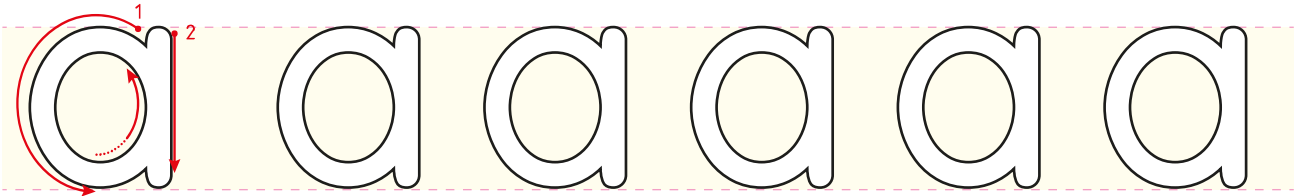

a a a a a a a a a a a a a a a

a a a a a a a a a a a a a a a

a a a a a a a a a a a a a a a



☞ "a" harfini yazalım.

a a a a a a a a a a

a a a a a a a

a a a a a a a

a

a

a

a

a

a

a

a

a



👉 Arabayı eve ulaştıran yolu bulalım.

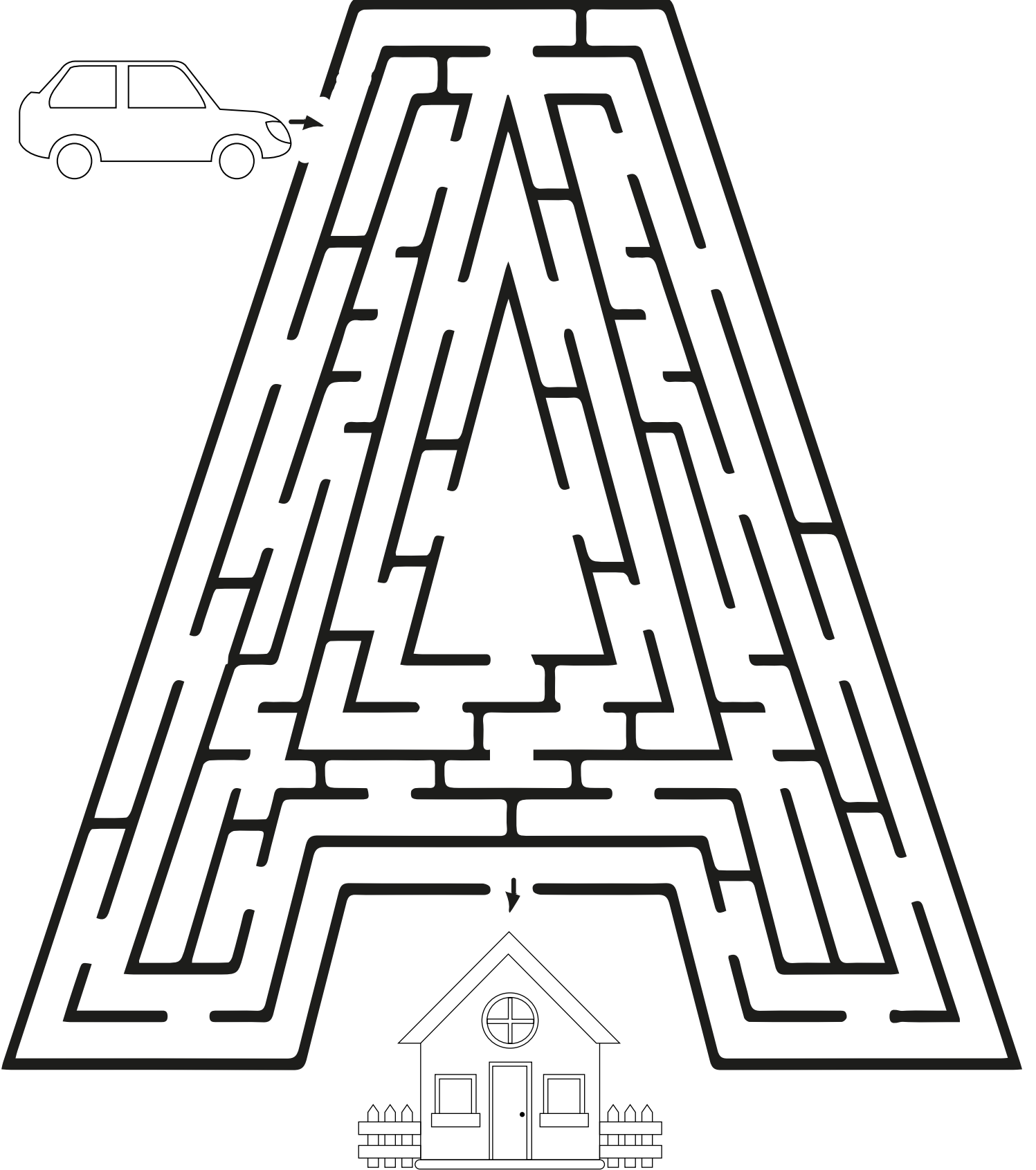
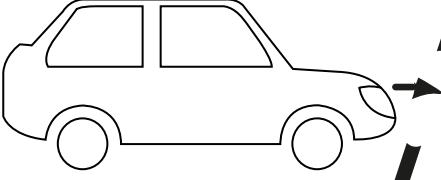



👉 Büyük "A" ve küçük "a" harfini yazalım.

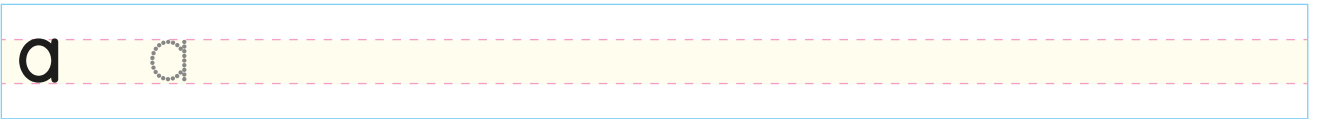
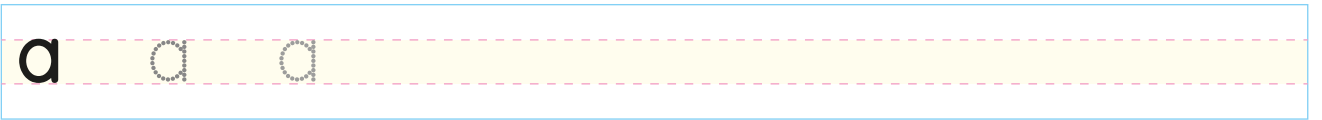
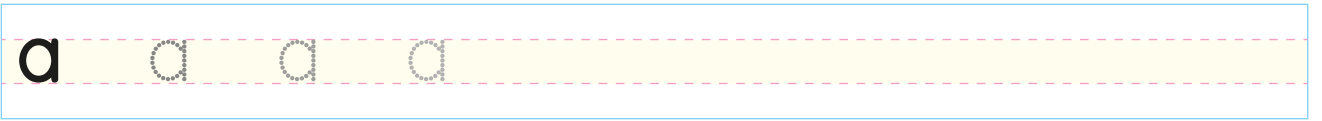
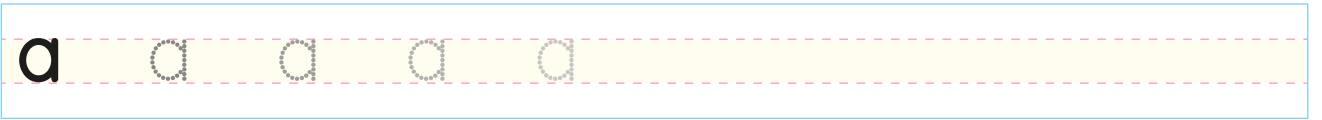
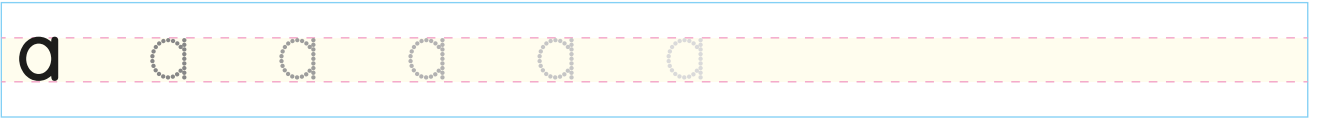
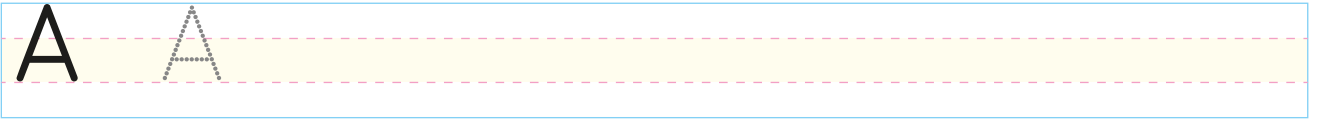
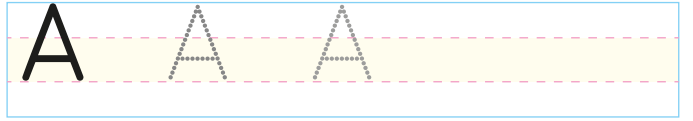
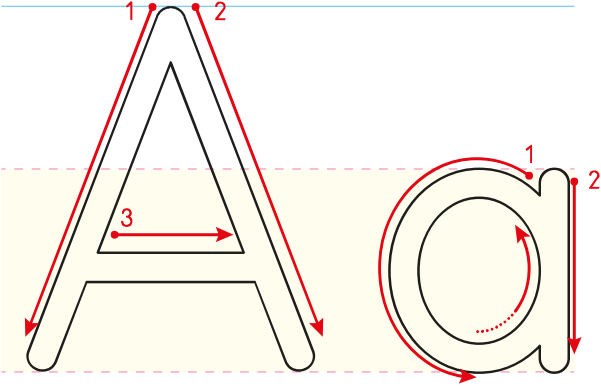



Okuyalım, yazalım.

a l al



al al al al al

al al al

al

al

al

l a la

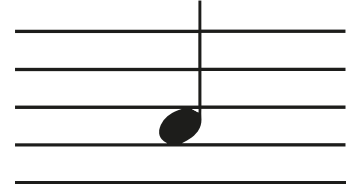

la la la

la la

la

la

la



Okuyalım, yazalım.

e la ela



ela ela ela ela ela

ela ela ela

ela

ela

ela

E la Ela



Ela Ela Ela

Ela Ela

Ela

Ela

Ela



Okuyalım, yazalım.

la le lale

lale

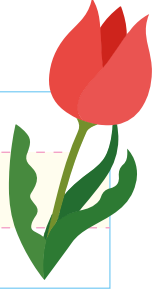

lale lale lale lale lale

lale lale lale

lale

lale

lale

La le Lale

Lale



Lale Lale Lale Lale Lale

Lale Lale Lale

Lale

Lale

Lale



Okuyalım, yazalım.

Ela lale al.



Ela lale al. Ela lale al.

Ela lale al. Ela lale al.

Ela lale al.

Ela lale al.

Ela lale al.

Okuyalım, yazalım.

EL ELE

El ele, el ele.

Ela el ele.

Lale el ele.

Ela lale el ele.

☞ Görseli verilen varlıkların yazılı olduğu kalpleri boyayalım.

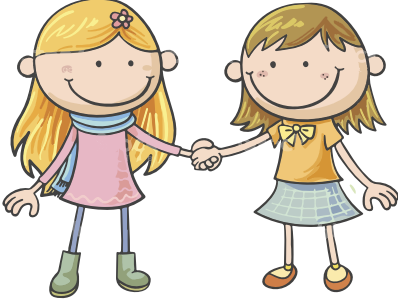
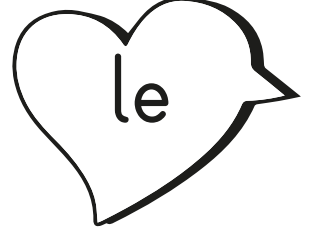
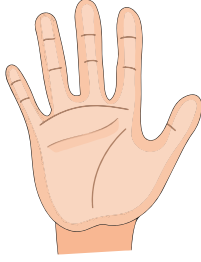
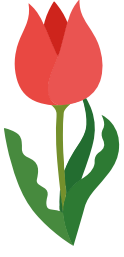

☞ Okuyalım, yazalım.

LALE AL

Handwriting practice box with a dashed line for tracing.

Ela al.

Handwriting practice box with a dashed line for tracing.

Lale al.

Handwriting practice box with a dashed line for tracing.

Ele lale al.

Handwriting practice box with a dashed line for tracing.

El ele lale al.

Handwriting practice box with a dashed line for tracing.

Ela lale al.

Handwriting practice box with a dashed line for tracing.



Okuyalım, yazalım.

a la ala



ala ala ala ala ala

ala ala ala

ala

ala

ala

al la alla



alla alla alla

alla alla

alla

alla

alla

Okuyalım, yazalım.

la la lala lala

lala lala lala lala lala

lala lala lala

lala

lala

lala

Okuyalım, görseli boyayalım.

ALA LALE

Ela lale al.

Ala lale al.

Ele ala lale al.

Ela ala lale elle.

Ela ele ala lale al.

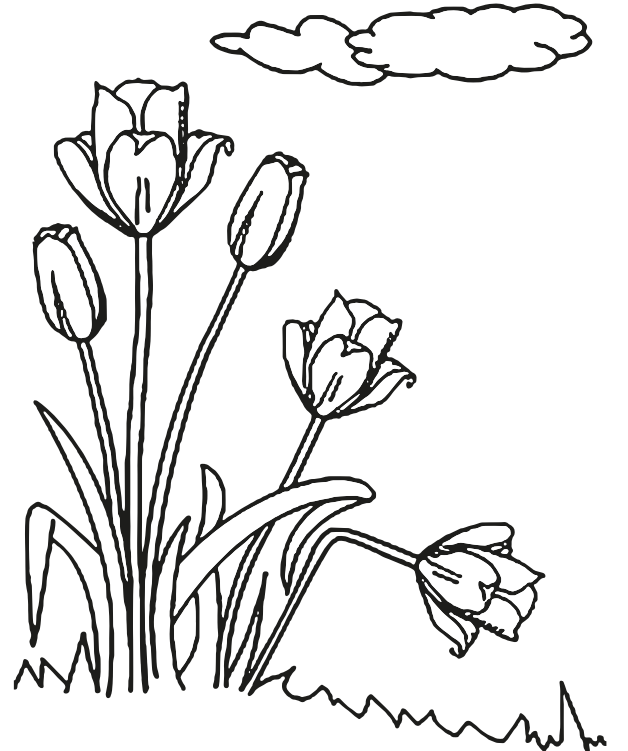



👉 2 rakamını yazalım.

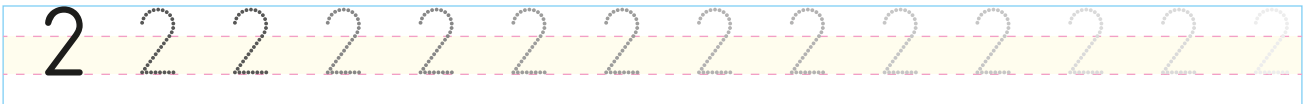
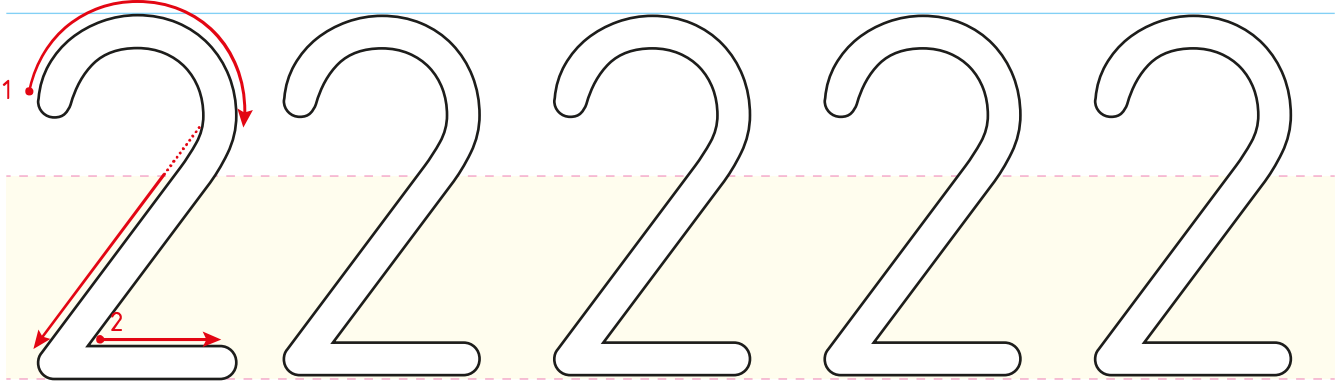

👉 Okuyalım, yazalım.

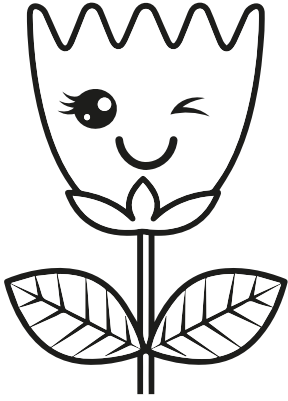

Ela lale al.

Ela lale al.

Ela Lale el ele.

Ela lale el ele.



El ele lale al.

El ele lale al.

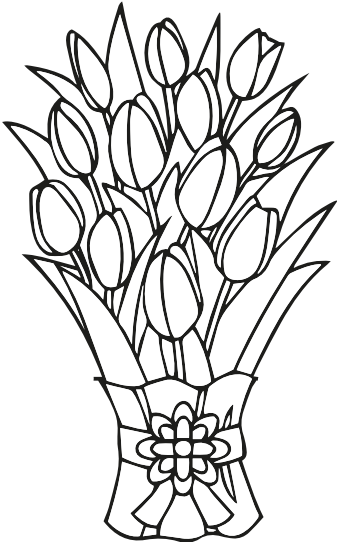



☞ Yönergeleri uygulayalım.

- Adı "a" sesi ile başlayan varlıkların görselini sayfanın aşağısındaki görsellerden yapıştıralım.

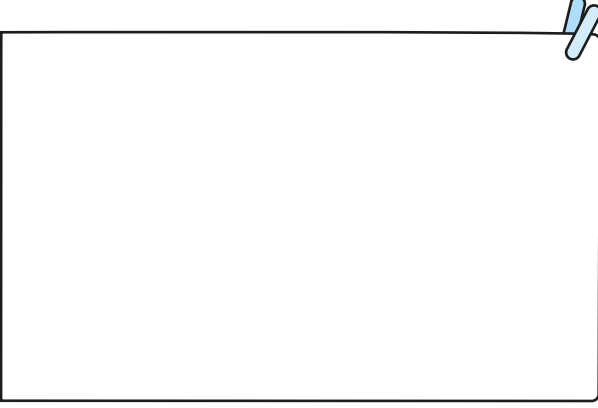

- Adı "a" sesi ile biten varlıkların görselini sayfanın aşağısındaki görsellerden yapıştıralım.

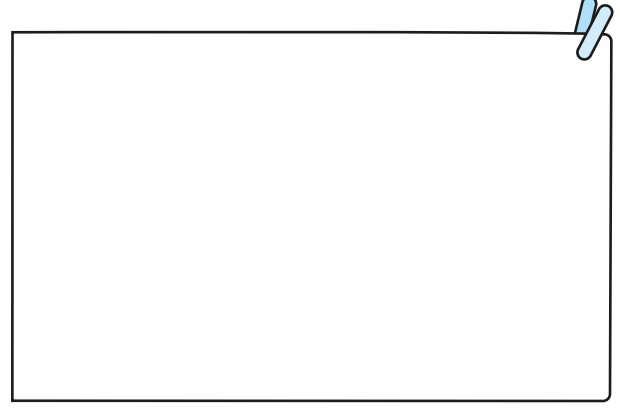

- Adında en çok "a" sesi olan görseli boyyalım.

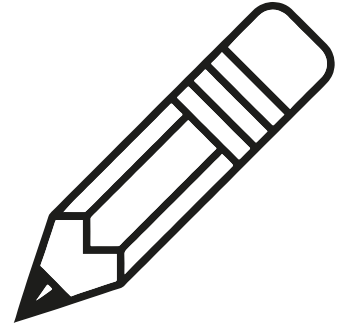
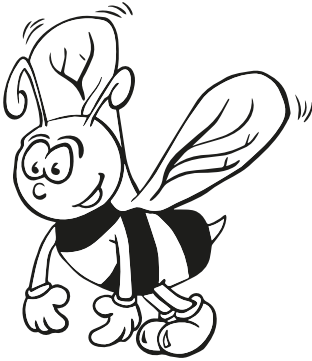

- Büyük "A" yazalım.

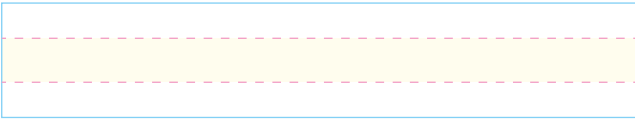

- Küçük "a" yazalım.

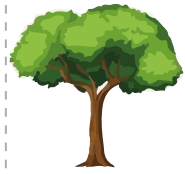
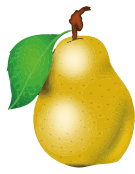
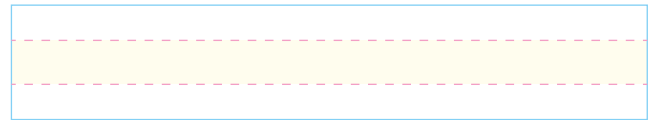
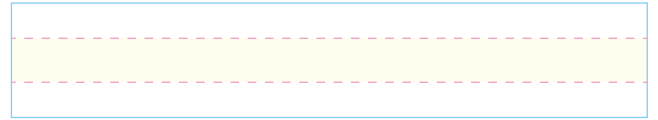

MATEMATİK

1

2

3

4

5

6

7

8

+

-

9

0

÷

×

=

?





👉 Varlıkların eşini bulup eşleştirelim.

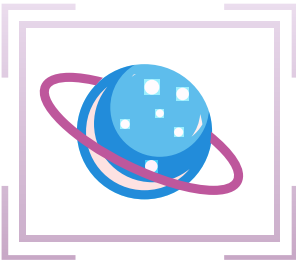
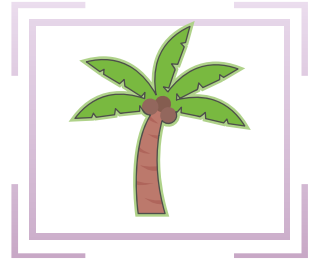
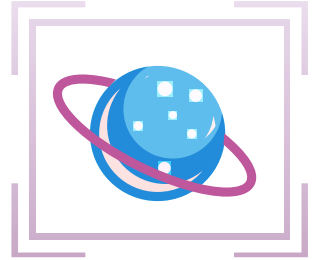
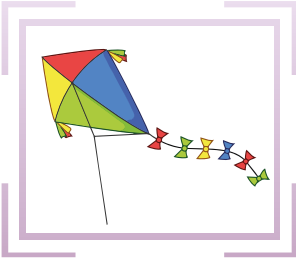
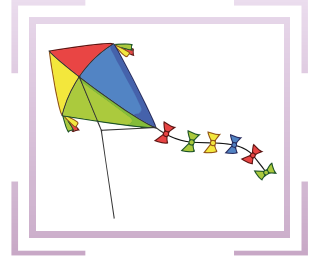
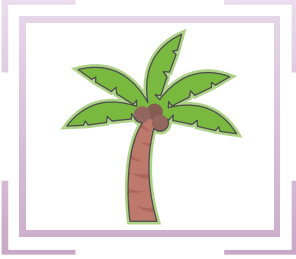

☞ Başta verilen varlığın eşini bulup işaretleyelim.

İki resim arasındaki 7 farkı bulalım.

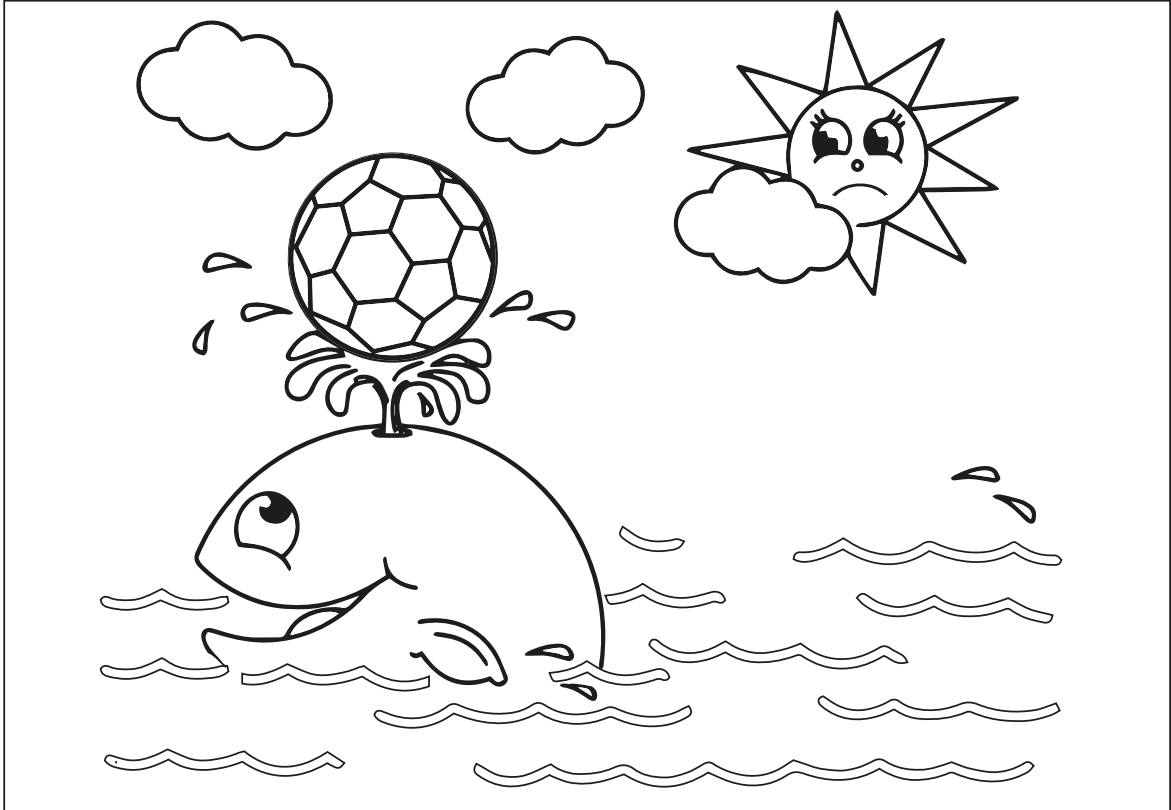
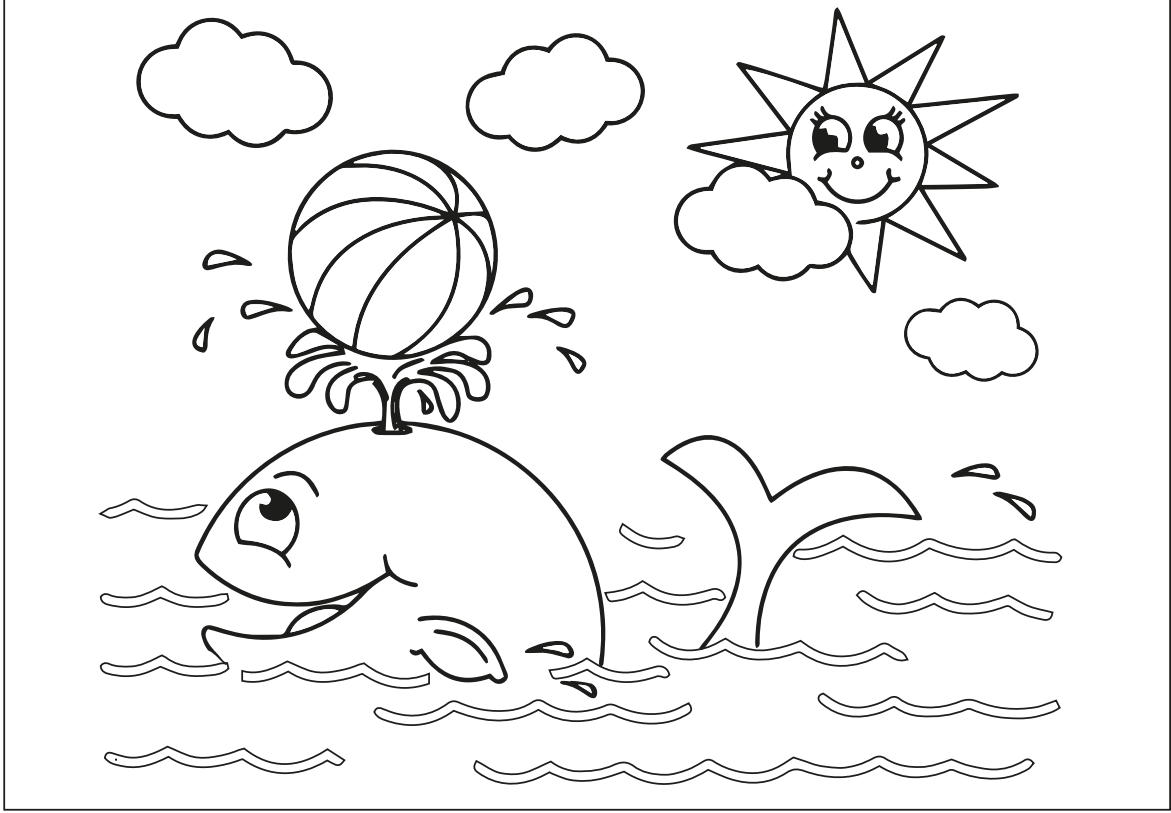

👉 Aşağıdaki harfleri eşleri ile eşleştirelim.

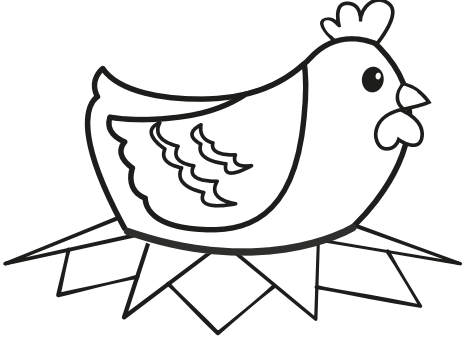

L

E

e

a

A

L

E

A

e

a

👉 Birbirine eş şekilleri eşleştirelim. Farklı olan şekilleri istediğimiz renge boyayalım.

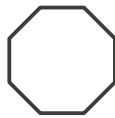
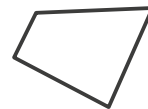
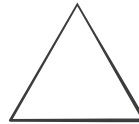
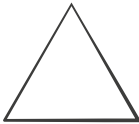
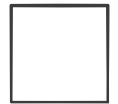
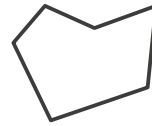
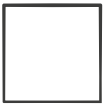
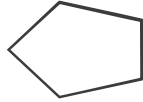



Her sıradaki varlıklardan daha ağır olanı işaretleyelim.

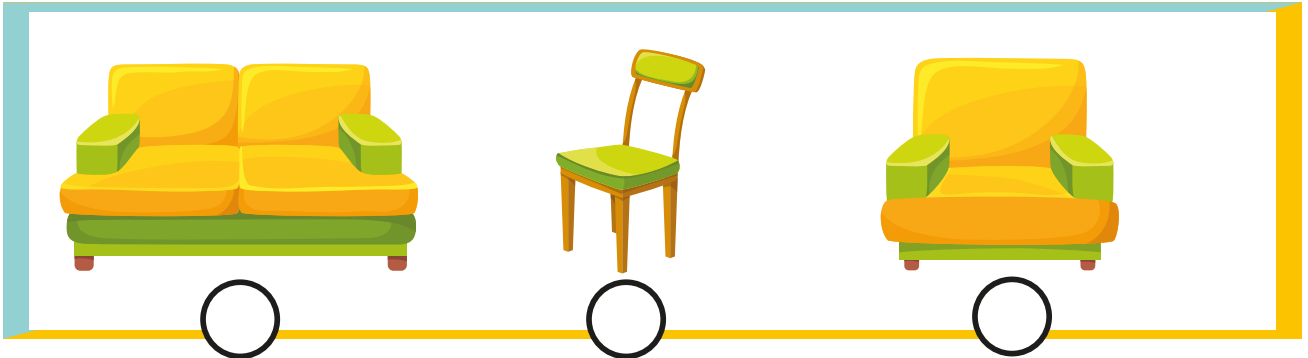
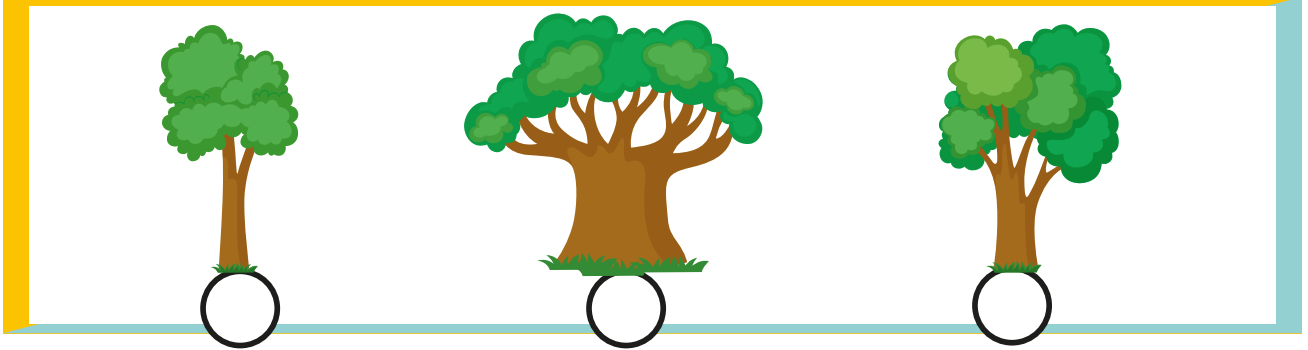

Her sıradaki varlıklardan daha hafif olanı işaretleyelim.

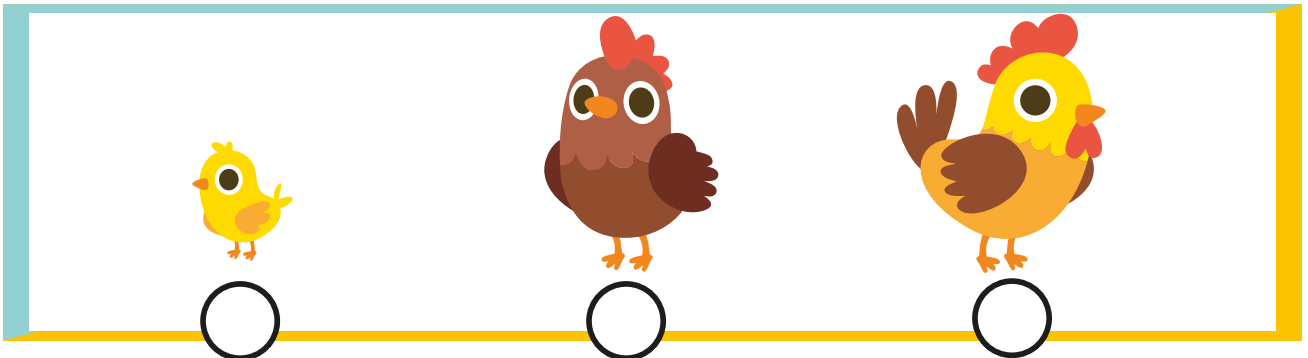
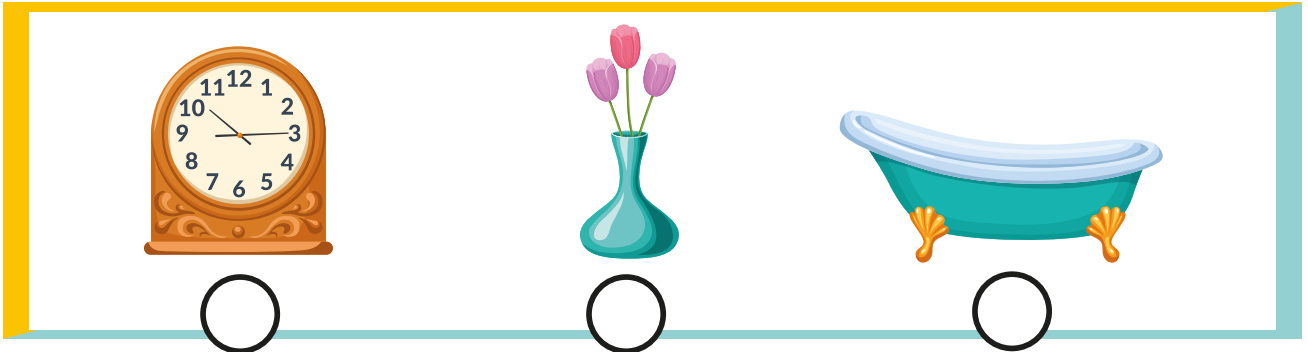

☞ Aşağıdaki varlık çiftlerinden ağır olanı mavi, hafif olanı sarıya boyyalım.

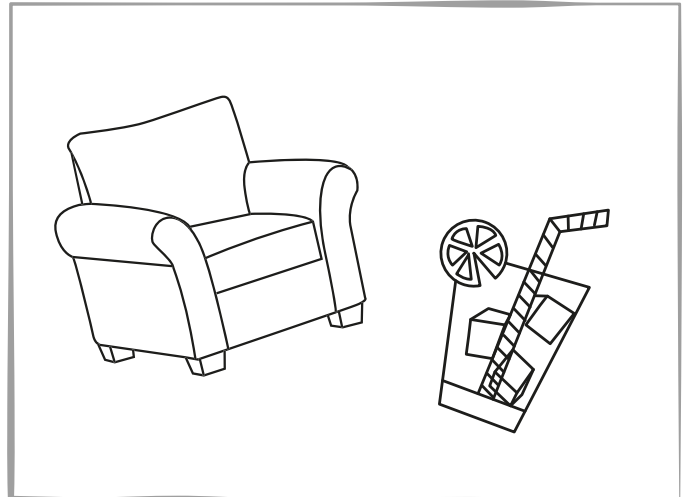
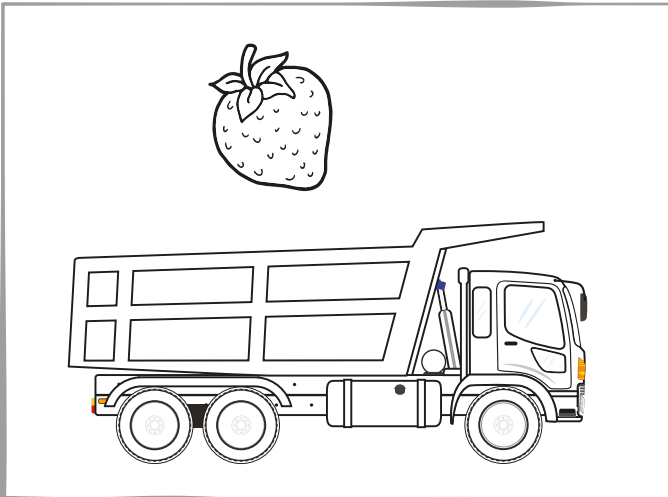
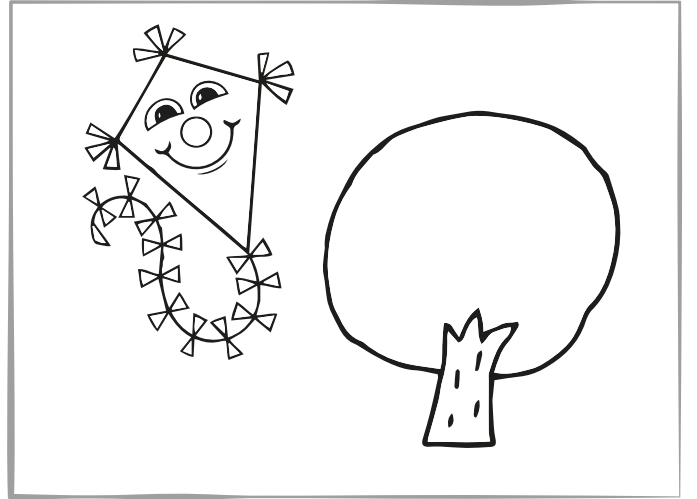
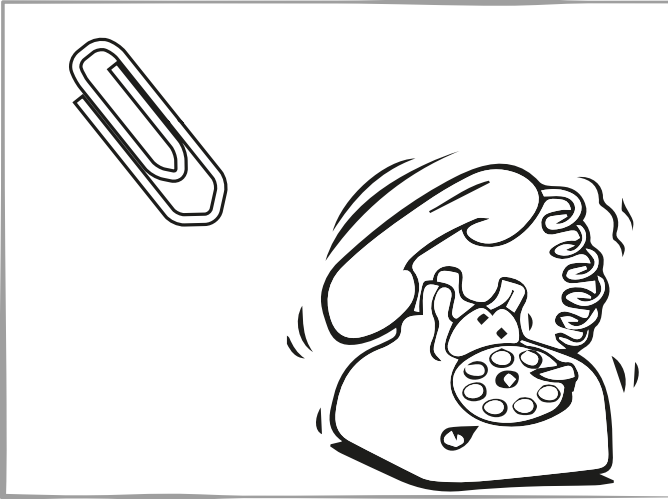
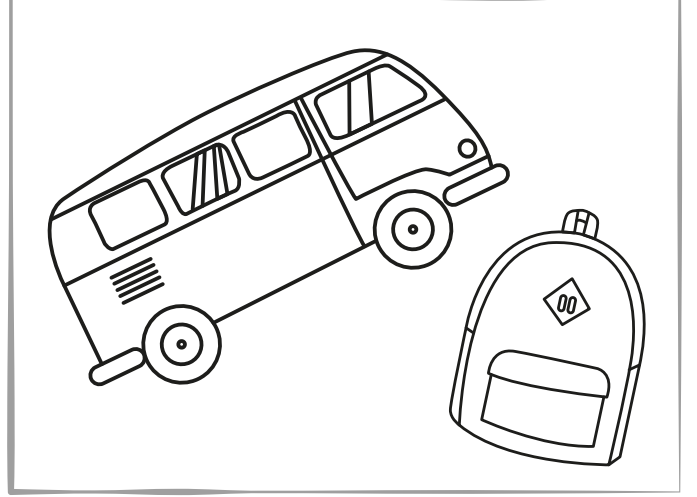
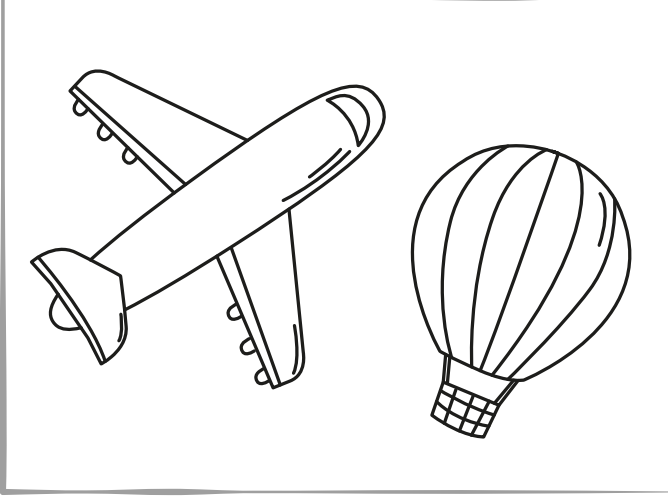

👉 Terazileri inceleyelim. Ağır olan varlıkları işaretleyelim.

