



Ü VE Y SESİ ÇALIŞMALARI



👉 Adında "ü" sesi bulunan varlıkları boyayalım.



👉 "ü" sesi ile başlayan varlıkları işaretleyelim.

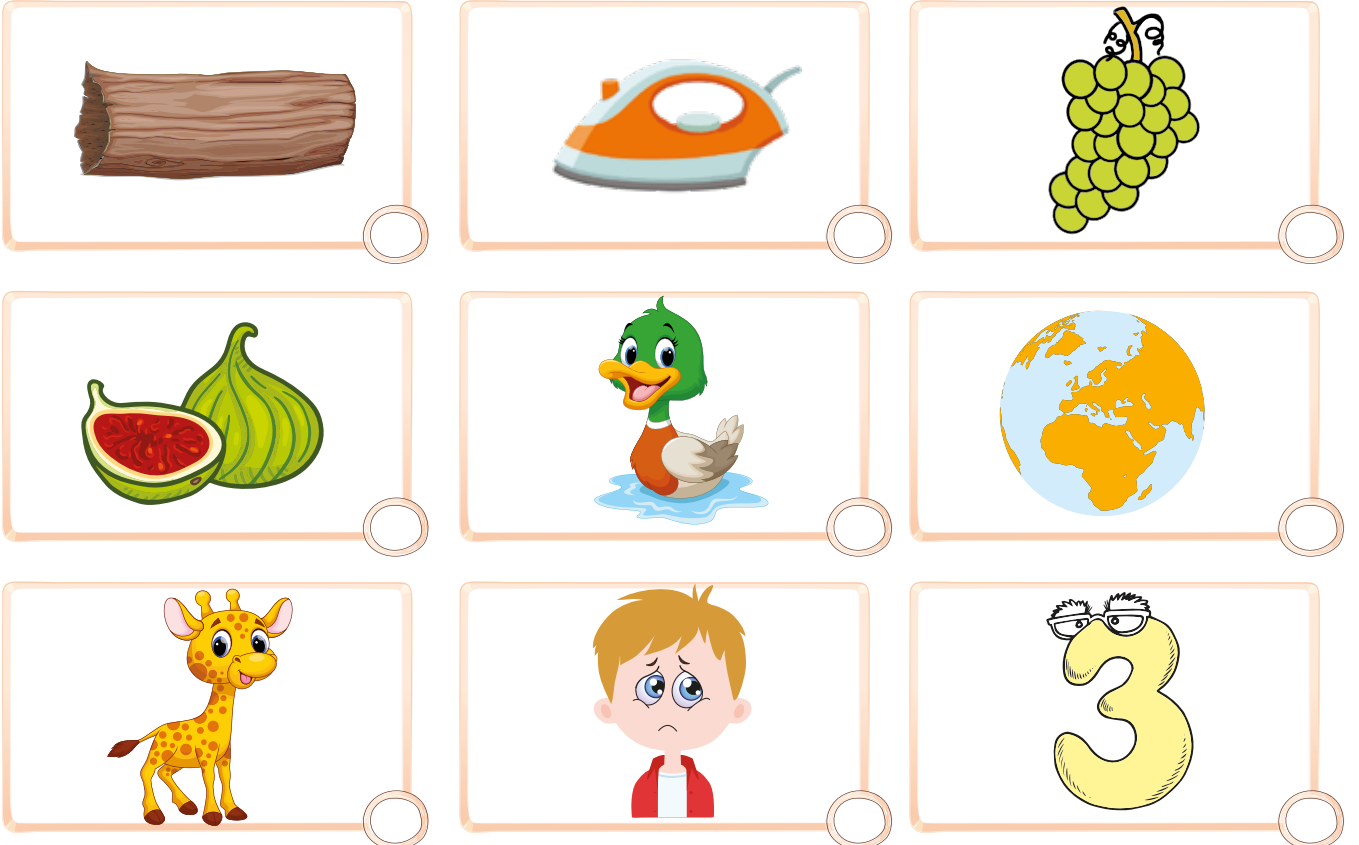

☞ Büyük "Ü" harfinin yazılış yönüne dikkat edelim. İçinden kalemimizle geçelim.

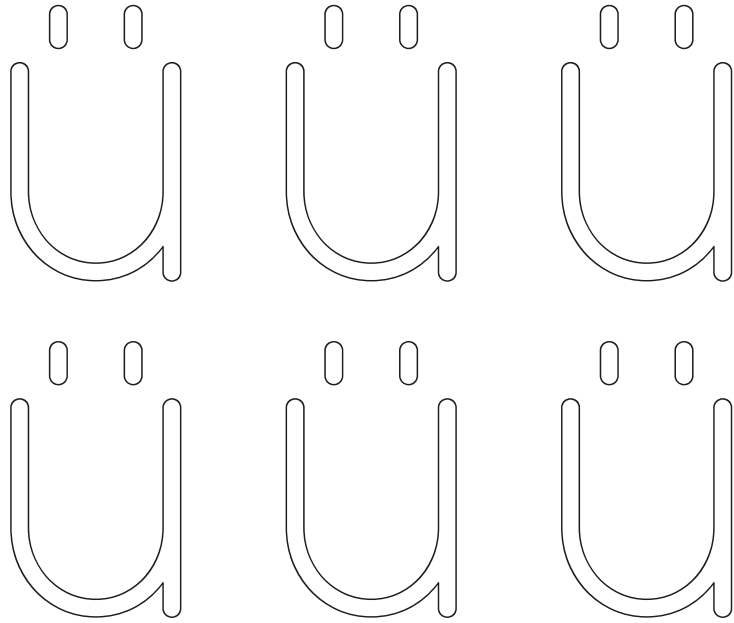
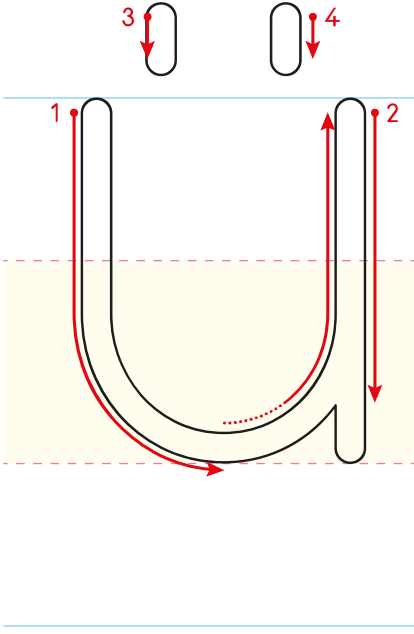

☞ "Ü" harfinin yazılı olduğu balonları boyayalım.

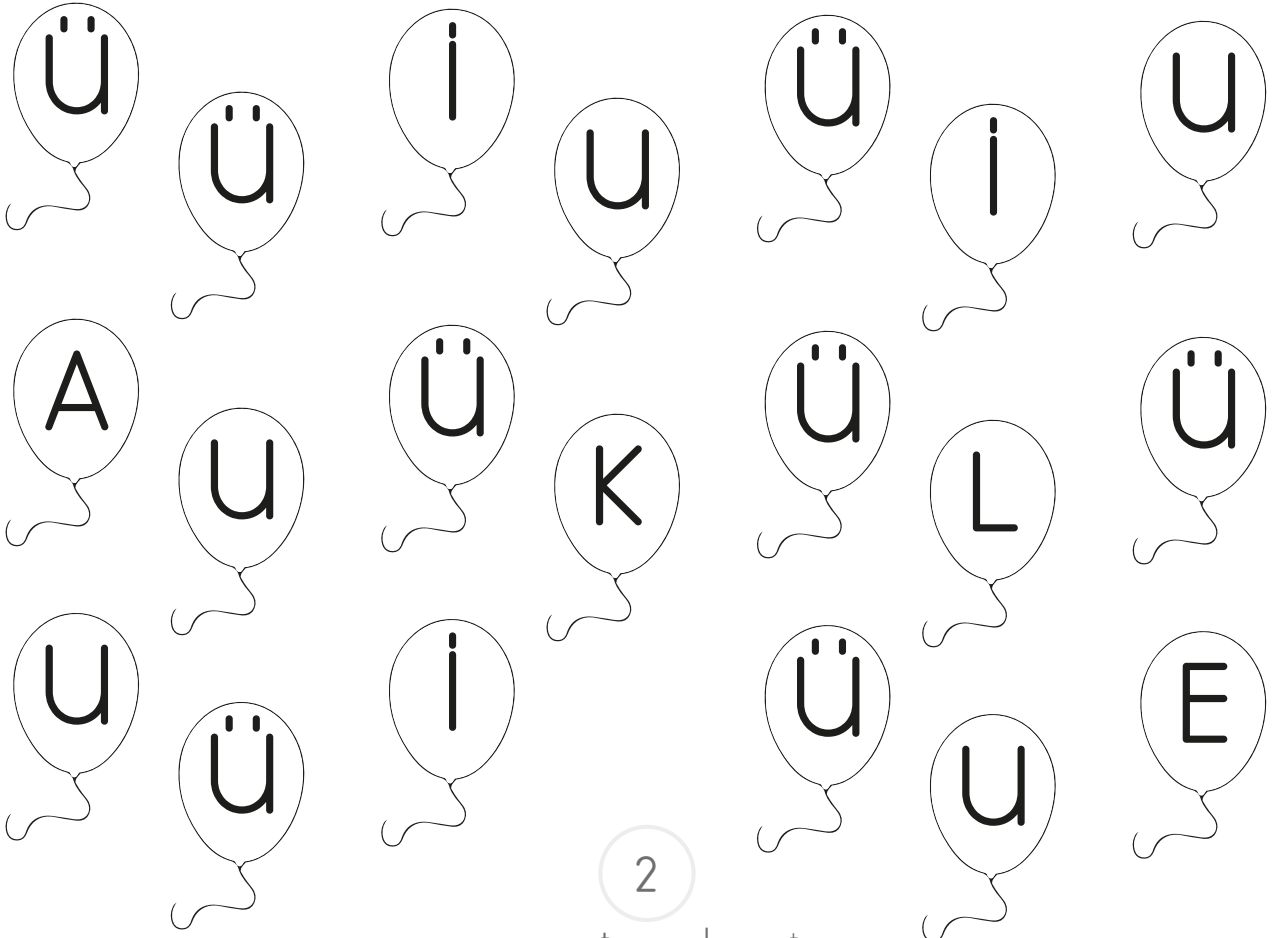

Yönergeleri uygulayalım.

• "Ü" harfini boyayalım.

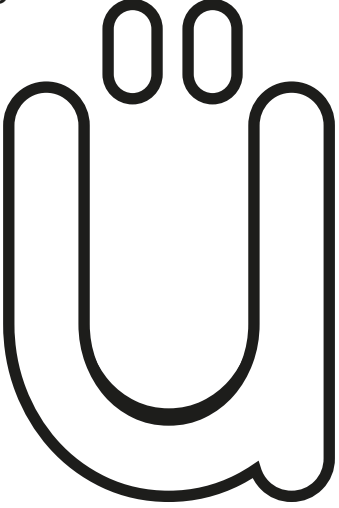

• "Ü" harflerini bulup yuvarlak içine alalım.

N U o ü
u k e ü
ü A u ü

• Noktaları birleştirelim.

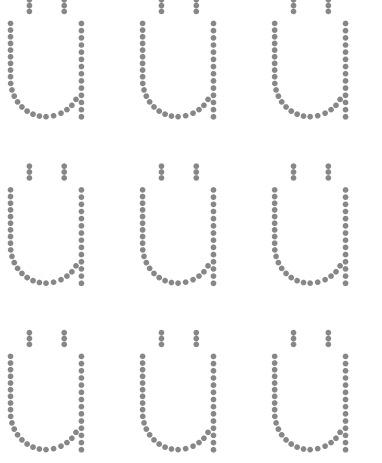

Yazma yönlerine dikkat ederek "Ü" harfini yazalım.

1 2 3 4

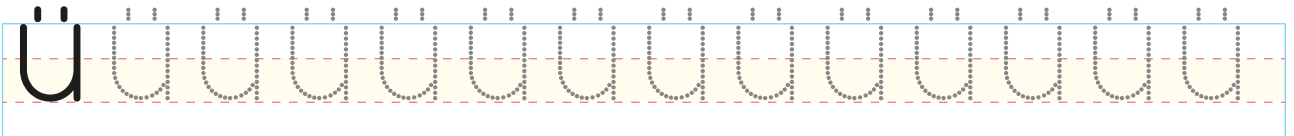
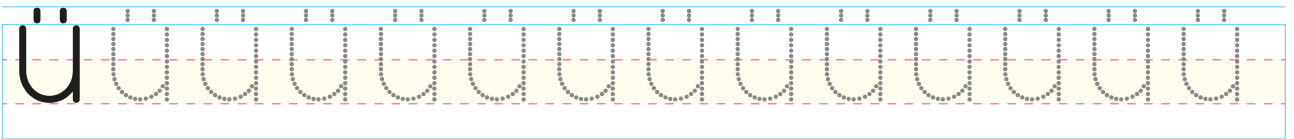
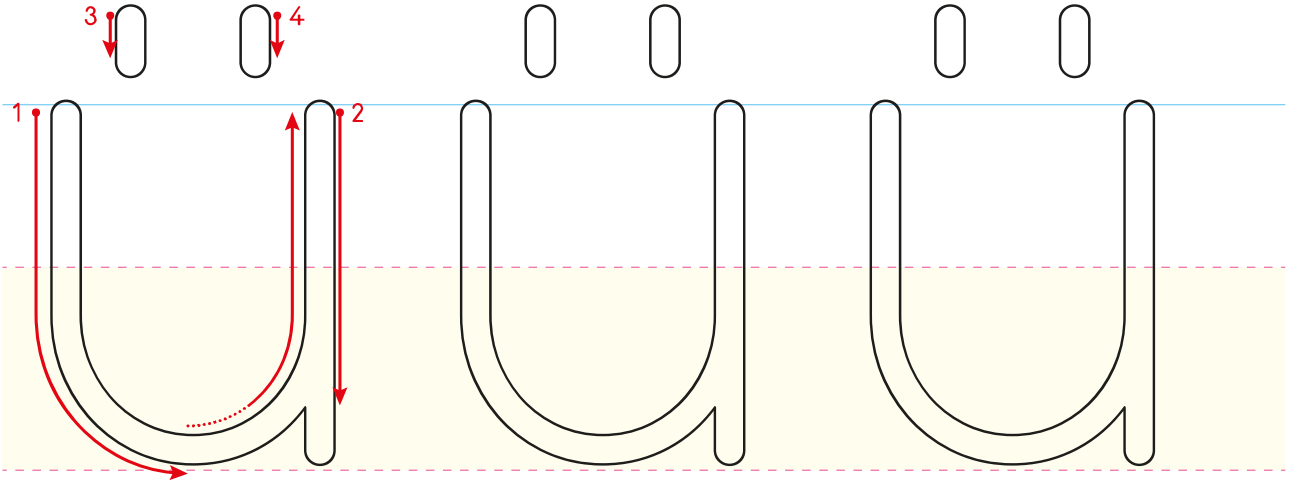



☞ "Ü" harfini yazalım.

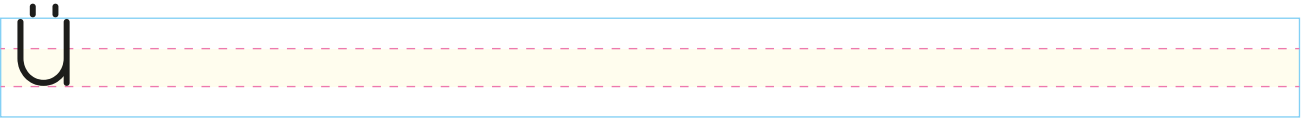
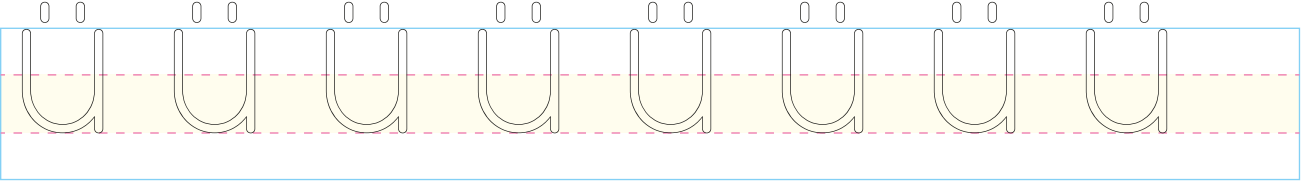



☞ Küçük "ü" harfinin yazılış yönüne dikkat edelim. İçinden kalemimizle geçelim.

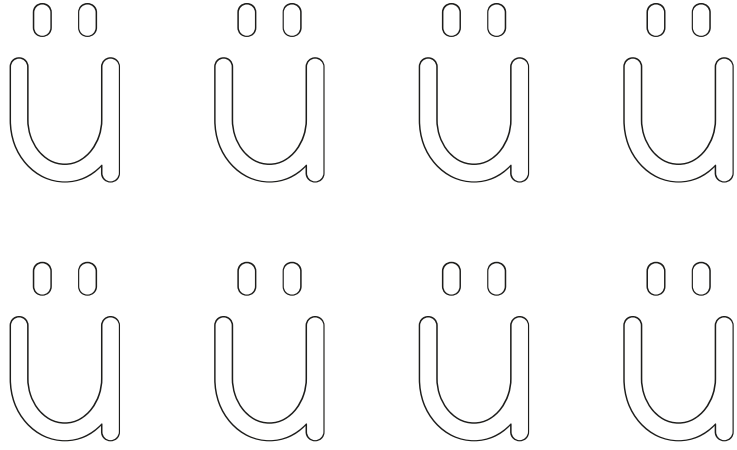
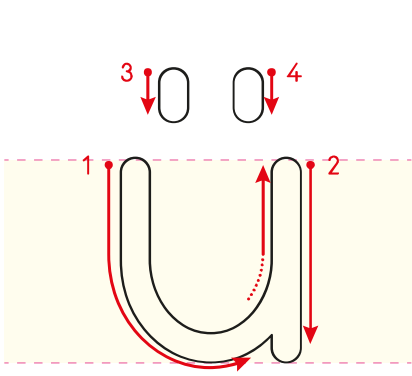

☞ "ü" harfinin yazılı olduğu yıldızları boyayalım.





☞ "ü" harfini yazalım.

ü ü ü ü ü ü ü ü ü ü ü ü ü

ü ü ü ü ü

ü ü ü ü

ü

ü

ü

ü

ü

ü

ü

ü

ü



👉 Büyük "Ü" ve küçük "ü" harfini yazalım.

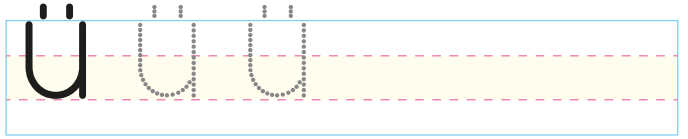
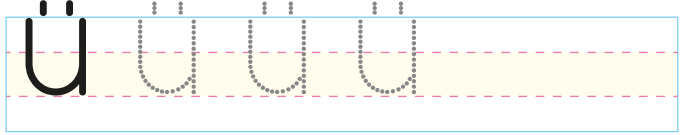
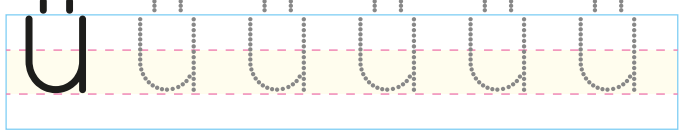
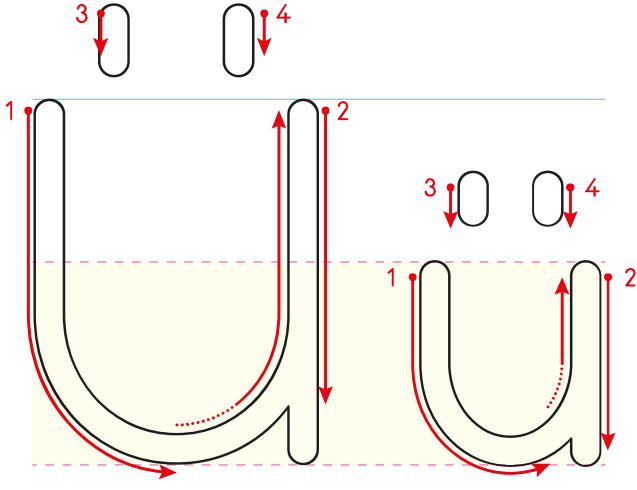

Ü ü

ü ü ü ü ü

ü ü ü

ü ü

ü ü

ü ü

ü



Okuyalım, yazalım.

ü l ül ül

ül

l ü lü lü

lü

ü k ök ök

ök

k ü kü kü

kü

ül ke ülke

Ül kü Ülkü

ü n ün ün

ün

n ü nü nü

nü

ün lü ünlü

Ünlü ülke.

Ülkü o ülke ünlü ülke.



Okuyalım, yazalım.

ü m üm üm

m ü mü mü

üm

mü

ü t üt üt

t ü tü tü

üt

tü

tü mü tümü

üt me ütme

ü tü ütü

Tü lin Tülin

Tülin tümünü ütme.

Blank writing line for the sentence "Tülin tümünü ütme."

Tülin o tülü ütüle.

Blank writing line for the sentence "Tülin o tülü ütüle."



Okuyalım, yazalım.

a	kü		Ü	mit	
me	nü		Ü	nal	
kü	tük		ül	kem	
ün	lem		kü	me	
ka	kül		tü	nek	

Ünal o akü.

Ülkem ünlü.

Ümit o kütük.

Menü oku.

O tünekte.

Ülkemi anlat.

Tülin küme ol.

Okuyalım, yazalım.

TÜKET

Ünal ekmek tüket.
Ekmek ile et tüket.
Ünal tümünü ekle.
O et mükemmel.
Mükemmel eti tüket.



Handwriting practice line with a dashed middle line.

Handwriting practice line with a dashed middle line.

Handwriting practice line with a dashed middle line.

Handwriting practice line with a dashed middle line.

Handwriting practice line with a dashed middle line.

Handwriting practice line with a dashed middle line.



Okuyalım, yazalım.

k a ü t ü ü n ü^m e t i^m ü

t n l ü e ü l n m e Ü a l n Ü l ü k

Heceleri eşleştirip kelimeler oluşturalım.

mü tü tim ak la kat tü ke el

Okuyalım, yazalım.

Ümit ünlü ol.

O tünel mi?

Ona akü al.



☞ Karışık kelimelerden cümleler oluşturup yazalım.

al

Ümit

ütü

kaliteli

Ünal

atlet

annene

al

ekmek

tüketme

Ülkü

iki

tül

Tülin

iki

ütüle

kim

ünlü

olan

Ünal

Tülin

akü

otona

al

☞ Görseli verilen varlıkların adını yazalım.

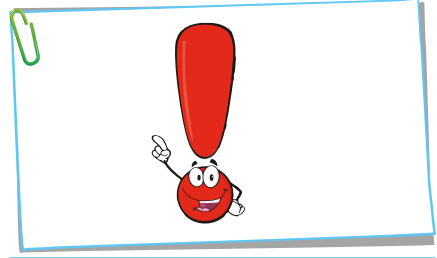

.....

.....

.....

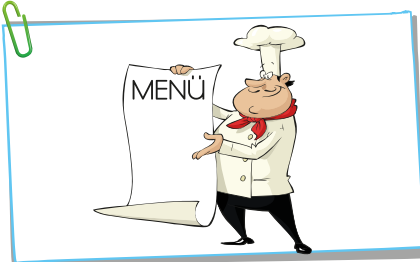
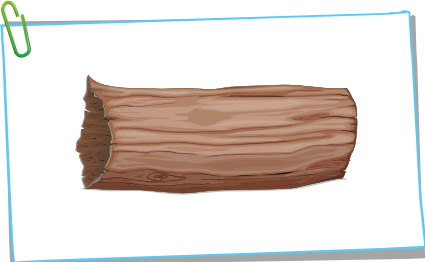

.....

.....

.....

☞ Noktalı yerleri uygun kelimelerle tamamlayalım.

ülkeni

ütü

ünlü

külü

akü

☞ O komutan.

☞ Ümit, Ünal'a anlat.

☞ Ünal, al, onu otana tak.

☞ Tülü kaliteli ile ütüle.

☞ Ünal, Tülin ile at.

☞ Metni okuyalım. Aşağıya yazalım.

ÜNLÜ ÜLKE

Ümit, ülkeni Ünal'a anlat.

Ülkenin tüneline anlat.

Ülkenin tüneli ünlü.

Ümit tüneli Ünal'a anlat.

Ünal'a ünlü ülkeni anlat.

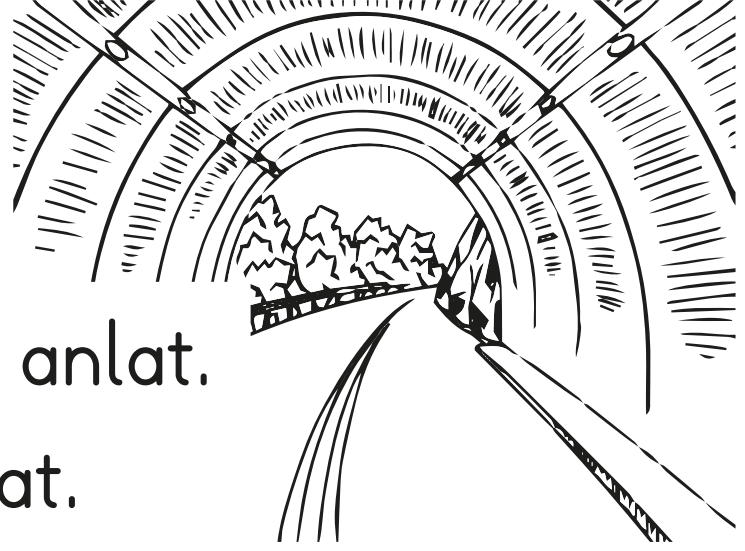

Handwriting practice line with a dashed middle line.

Handwriting practice line with a dashed middle line.

Handwriting practice line with a dashed middle line.

Handwriting practice line with a dashed middle line.

Handwriting practice line with a dashed middle line.

Handwriting practice line with a dashed middle line.



👉 0 rakamını yazalım.

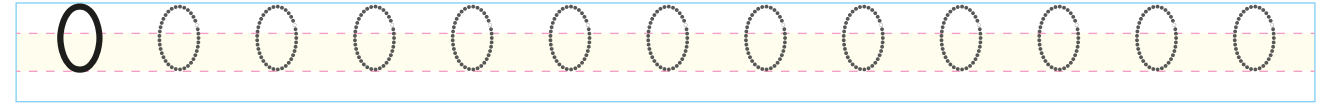
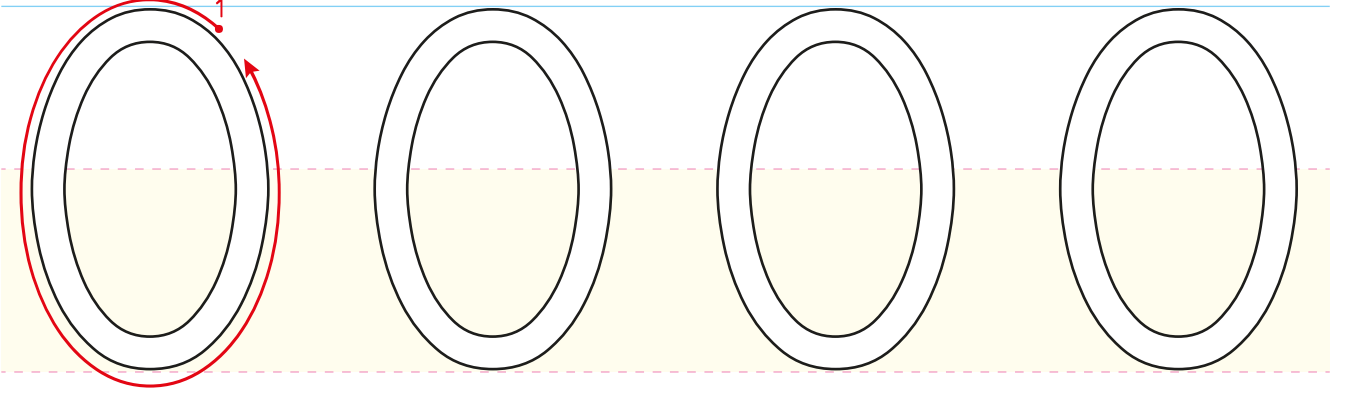

👉 Metni okuyalım. Aşağıya yazalım.

NÜKET

Nüket atleti ütüle.
Ütülü atleti katla.
O atlet Ülkü'nün.
Ülkü'nün atletini katla.
Ütüle ütüle katla.



Blank writing area with a dashed line for tracing.

Blank writing area with a dashed line for tracing.

Blank writing area with a dashed line for tracing.

Blank writing area with a dashed line for tracing.

Blank writing area with a dashed line for tracing.

Blank writing area with a dashed line for tracing.



☞ Cümleleri okuyalım. Soruları cevaplayalım.

Ünal ülkeni anlat.

Kim ?

Ülkü ütü al.

Ne ?

Nüket külü at.

Kim ?

Ümit ünlü ol.

Ne ?

O Ülkü'nün tülü.

Kimin ?

Ütü ile ütüle.

Ne ile ?

O Ünal'ın atleti.

Kimin ?

O tünel ünlü.

Ne ?

Tülin'e ütü al.

Kime ?

Ümit akü tak.

Ne ?

Ülkü ekmek tüket.

Kim ?

Nüket o menü.

Ne ?



Metni okuyalım. Soruları cevaplayalım.



TÜLİNİN TÜLÜ

Anne o tül kimin? Ünal o tül Tülin'in. Tülin'in tülü iki tane. Onun tülünü ütüle. Ama mükemmel ütüle. Tamam anne. Ünal tülü tuttu. Ütü ile tuttu. Tülin'i mutlu etti.

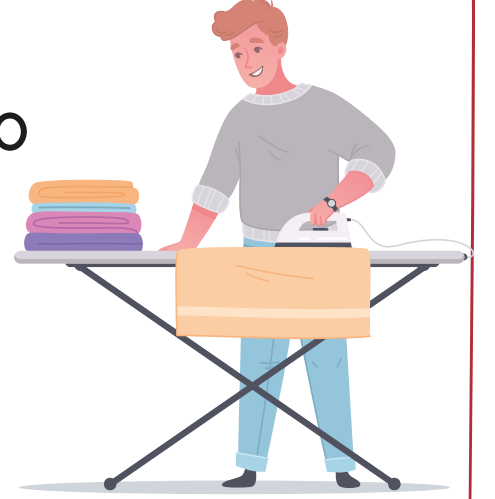

1. O tül kimin?

2. Ünal ne tuttu?

3. Ünal kimi mutlu etti?

Yönergeleri uygulayalım.

- Kız isimlerini sayfanın aşağısından kesip yapıştıralım.

- Erkek isimlerini sayfanın aşağısından kesip yapıştıralım.



- Adında en çok "ü" sesi olan görseli boyayalım.

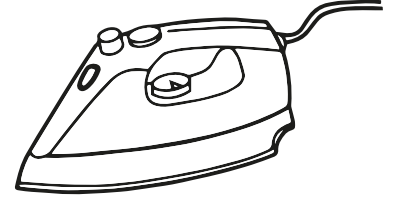
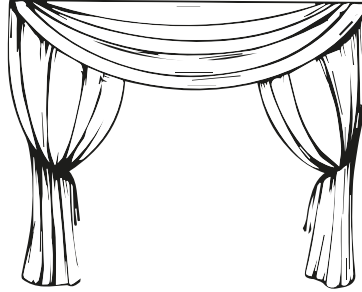
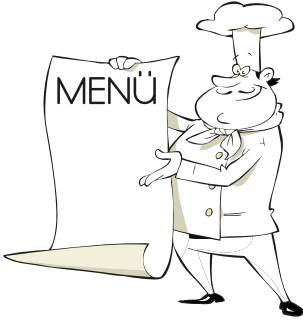

- Büyük "Ü" yazalım.

- Küçük "ü" yazalım.

Two sets of handwriting practice lines for the uppercase letter 'Ü'. Each set consists of a solid blue top line, a dashed red middle line, and a solid blue bottom line.

Two sets of handwriting practice lines for the lowercase letter 'ü'. Each set consists of a solid blue top line, a dashed red middle line, and a solid blue bottom line.

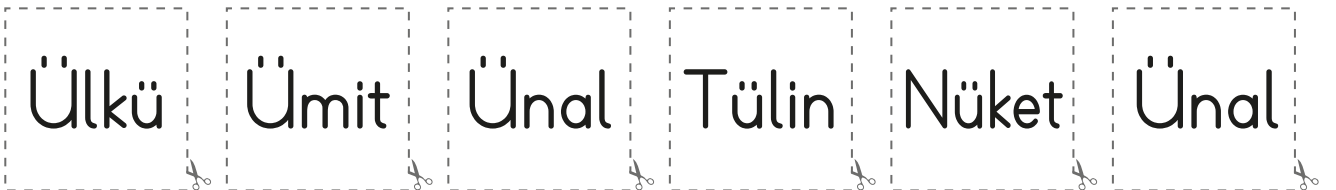

👉 Adında "y" sesi bulunan varlıkları boyayalım.

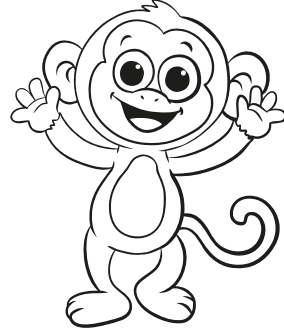
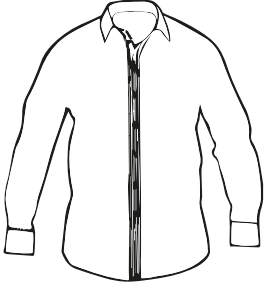
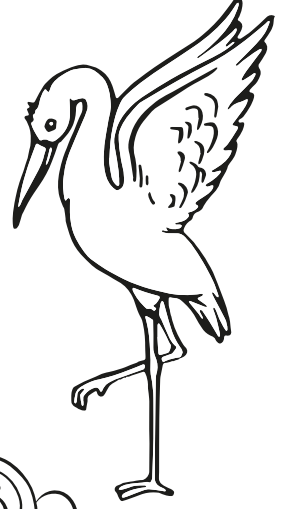
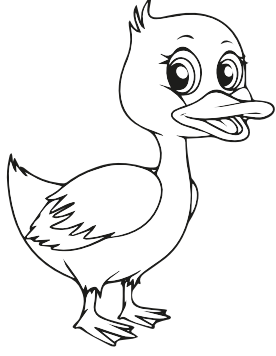

👉 "y" sesi ile başlayan varlıkları işaretleyelim.



👉 Büyük "Y" harfinin yazılış yönüne dikkat edelim. İçinden kalemimizle geçelim.

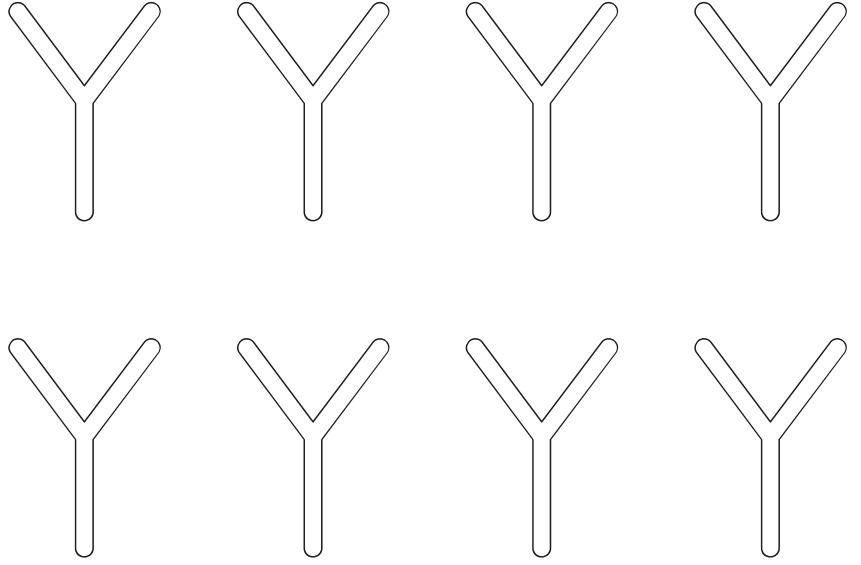
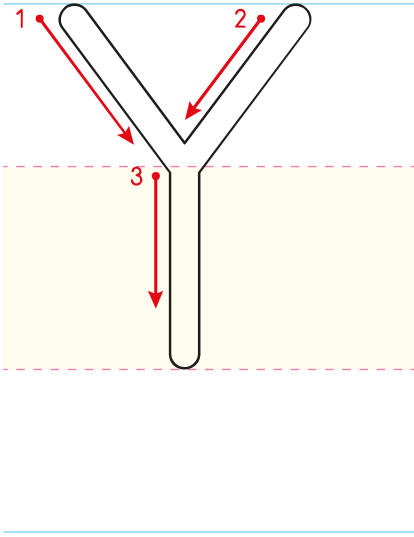

👉 "Y" harfinin yazılı olduğu balonları boyayalım.

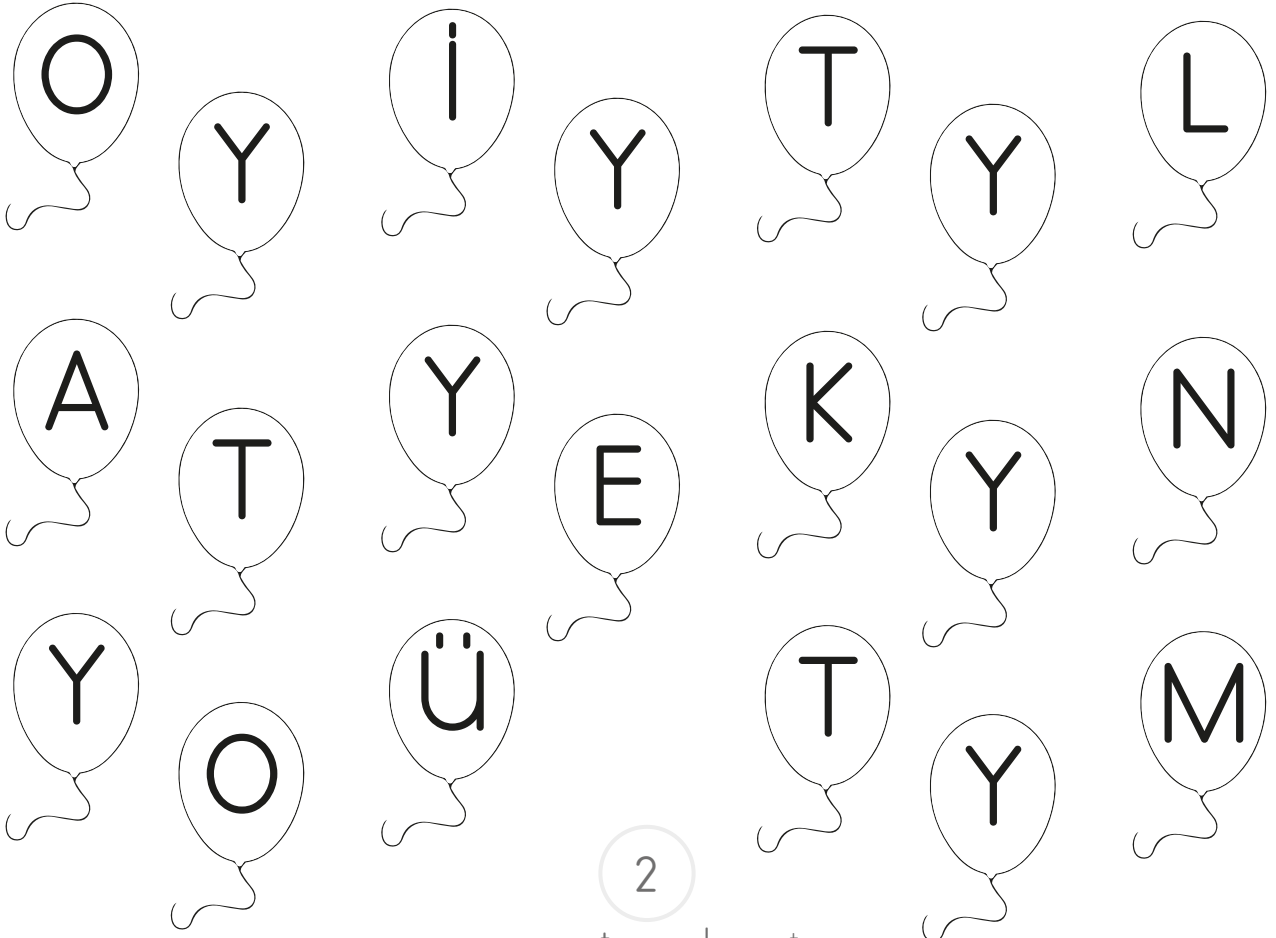

Yönergeleri uygulayalım.

• "Y" harfini boyayalım.

• "Y" harflerini bulup yuvarlak içine alalım.

• Noktaları birleştirelim.

Yazma yönlerine dikkat ederek "Y" harfini yazalım.



☞ "Y" harfini yazalım.

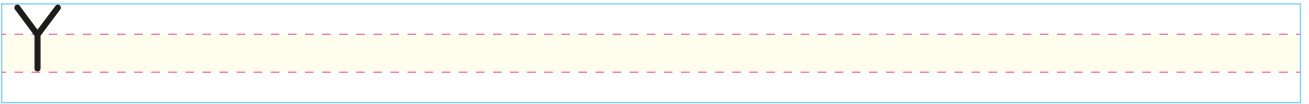
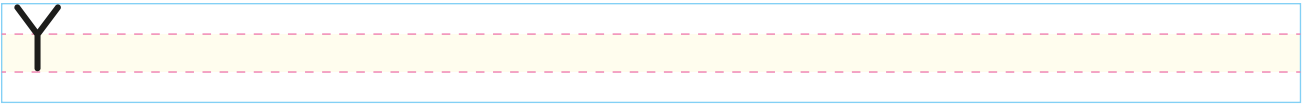
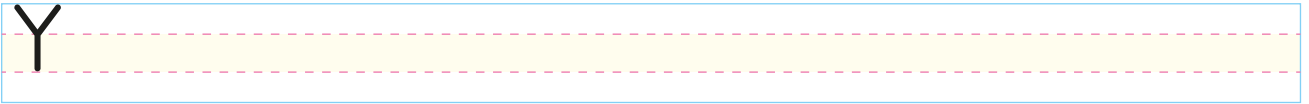
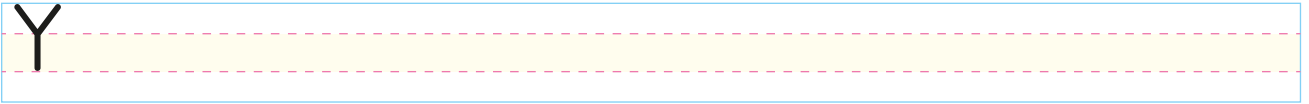
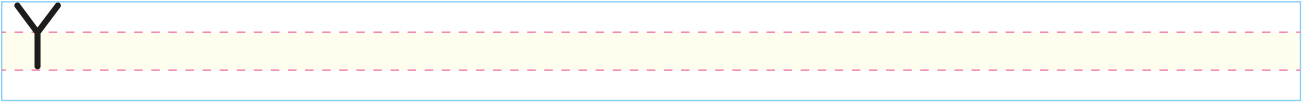
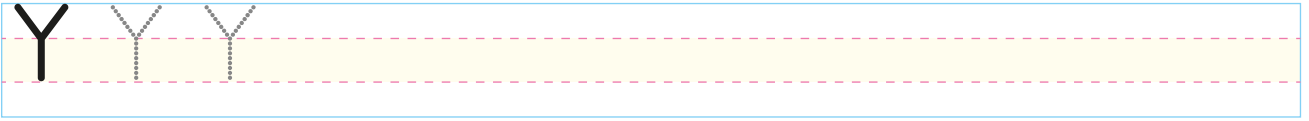
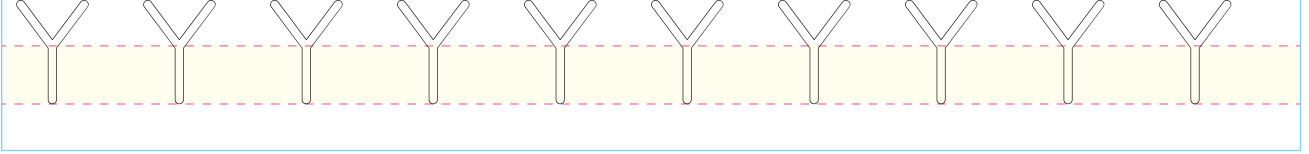



☞ Küçük "y" harfinin yazılış yönüne dikkat edelim. İçinden kalemimizle geçelim.

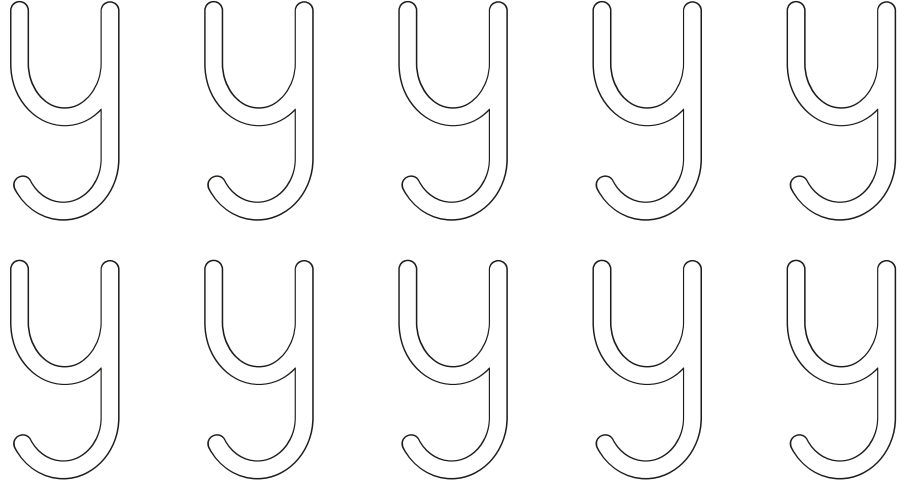
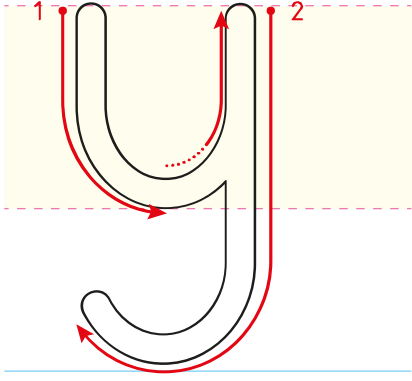

☞ "y" harfinin yazılı olduğu yıldızları boyayalım.



Yönergeleri uygulayalım.

• "y" harfini boyayalım.

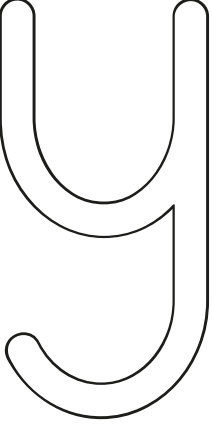

• "y" harflerini bulup yuvarlak içine alalım.

p y k ü
i k y
y y l o
t t y

• Noktaları birleştirelim.

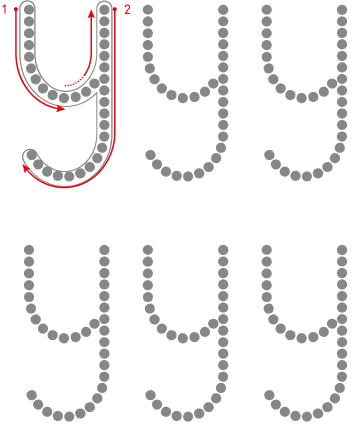

Yazma yönlerine dikkat ederek "y" harfini yazalım.

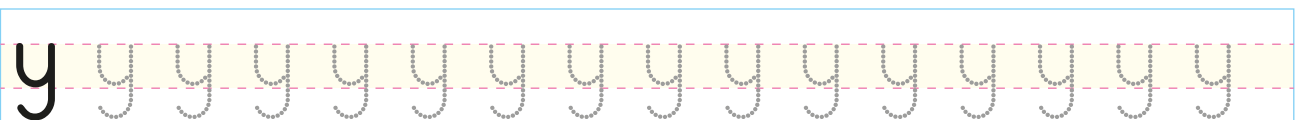
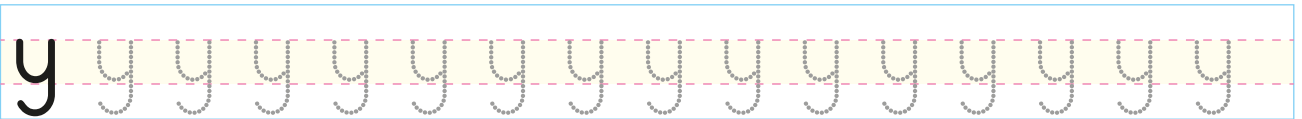
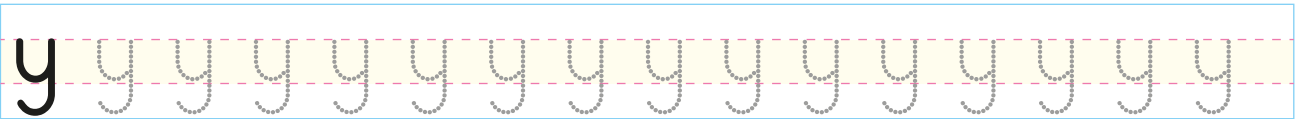
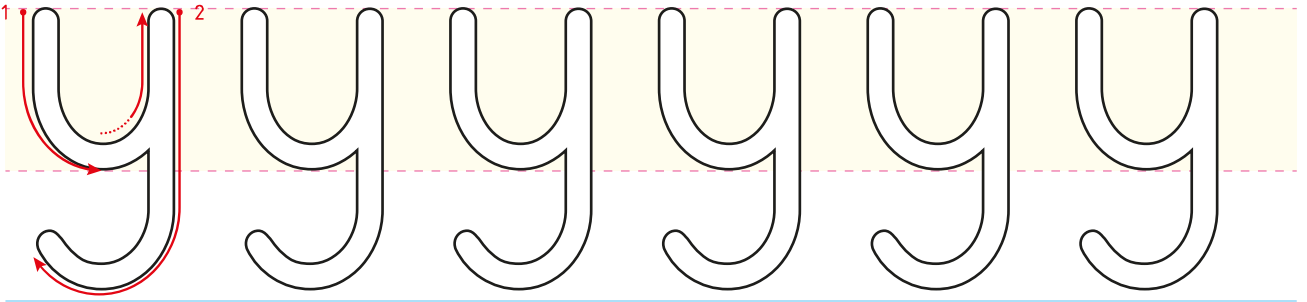



☞ "y" harfini yazalım.

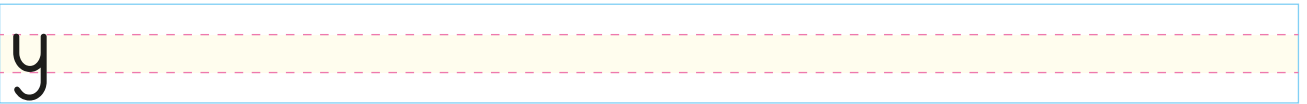
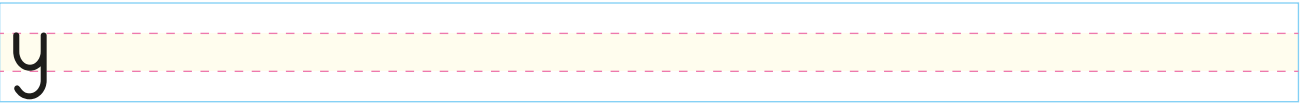
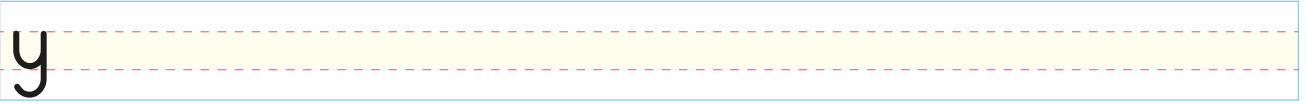
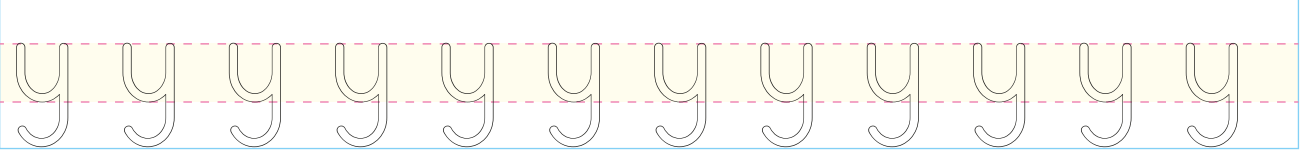



👉 Büyük "Y" ve küçük "y" harfini yazalım.

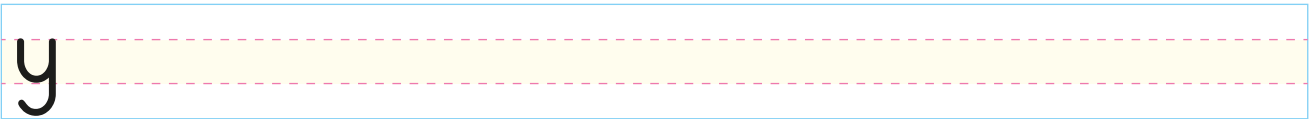
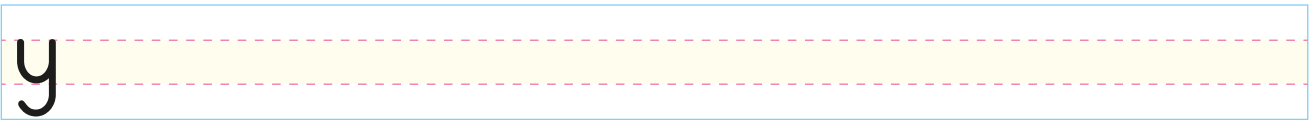
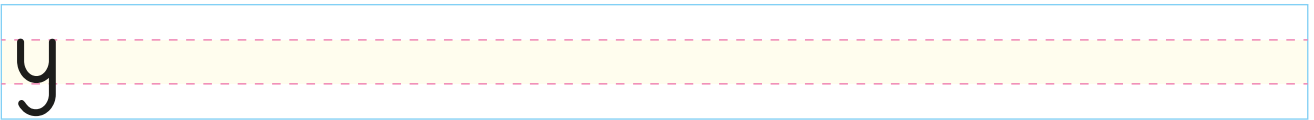
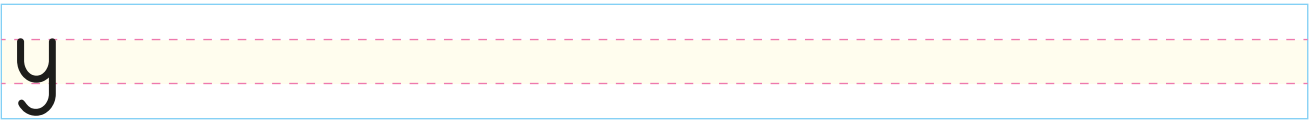
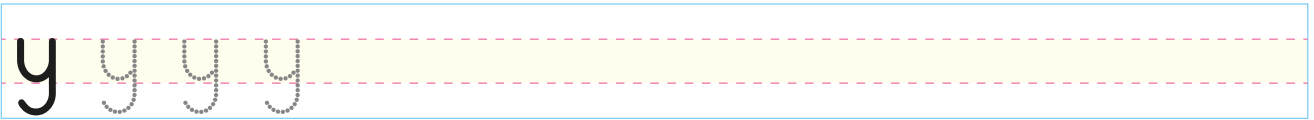
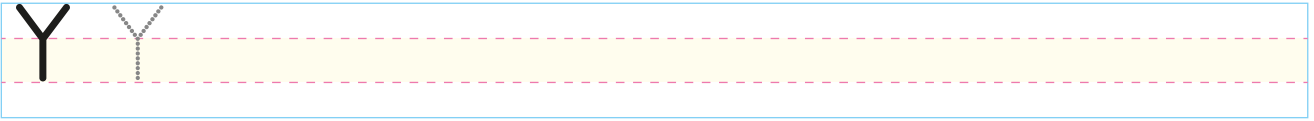
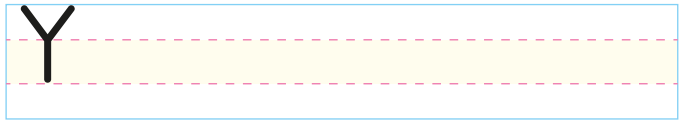
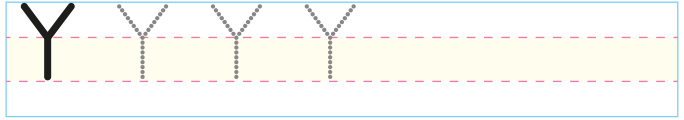
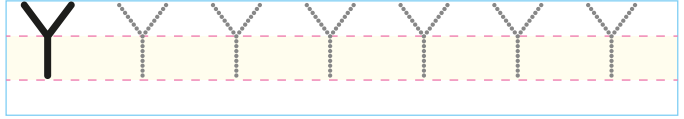
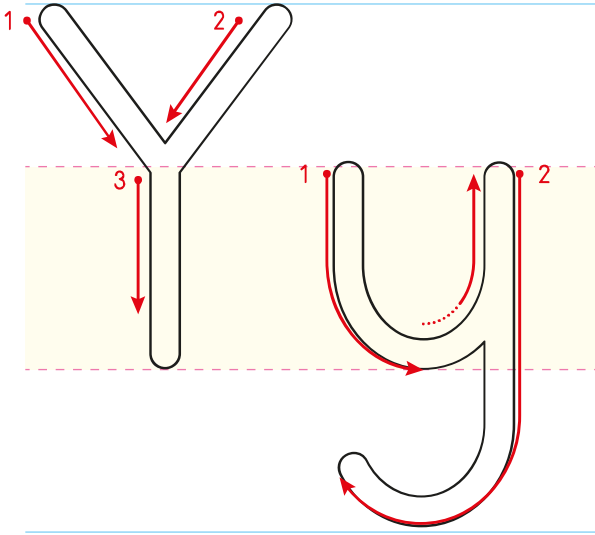



Okuyalım, yazalım.

e y ey ey

y e ye ye

ey

ye

a y ay ay

y a ya ya

ay

ya

Ey lül Eylül

ye ni yeni

ye mek yemek

Ay la Ayla

ya tak yatak

Ayla yemek ye.

Eylül yeni yatak al.



Okuyalım, yazalım.

i y iy iy

y i yi yi

iy

yi

o y oy oy

y o yo yo

oy

yo

i yi iyi

yi ne yine

oy na oynad

yo la yola

ma yo mayo

Oya mayo al.

İyi mayo al.

Yine oyna.



Okuyalım, yazalım.

u y uy uy

y u yu yu

uy

yu

ü y üy üy

y ü yü yü

üy

yü

uy ku uyku

ku yu kuyu

ko yun koyun

kö yü köyü

yün lü yünlü

Koyun yünlü.

Köyü yönet.

Uykulu olma.

Okuyalım, yazalım.

Ey men

Ay kut

Ay lin

Ay tül

Oy lum

Ka ya

yu mak

yel ken

kam yon

yol luk

kay mak

kim yon

Okuyalım, görseli boyayalım.

Kamyon ile oyna.

Aytül yumak al.

Kimyon kullan.

Eymen kaymak ye.

Yelken ile oyna.

Ayla yolluk al.

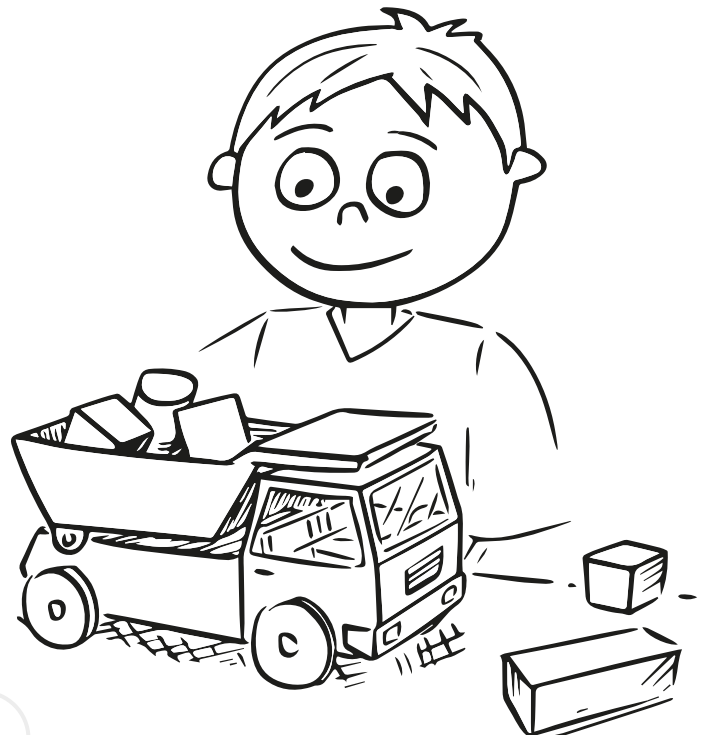



Okuyalım, yazalım.

KAMYONA YÜKLE

Kamyona yem yükle.

Yük ile yem yükle.

Kutay, kamyonu al.

Yeni kamyonu yükle.

İyi kamyonu yükle.



Blank writing line with a dashed midline for tracing practice.

Blank writing line with a dashed midline for tracing practice.

Blank writing line with a dashed midline for tracing practice.

Blank writing line with a dashed midline for tracing practice.

Blank writing line with a dashed midline for tracing practice.

Blank writing line with a dashed midline for tracing practice.

Okuyalım, yazalım.

a n y a e m y e k y u u k y a A l

k t y a o u n y l a y o k A n y i l

Heceleri eşleştirip kelimeler oluşturalım.

i ku lu uy tal lik An yi ya

Okuyalım, yazalım.

Antalya'da in.

Yalan yok.

Yatakta yat.



☞ Karışık kelimelerden cümleler oluşturup yazalım.

iki

Oya

al

leylek

Aykut

al

koyun

ona

oyna

ile

oyun

Ayla

Eylül

yolunu

yaya

kullan

Eymen

lila

Aleyna

iki

al

mayo

Oktay

yat

tüylü

yatakta

👉 Noktalı yerleri uygun kelimelerle tamamlayalım.

leylek

Yaman

kaymak

kuyuya

yak

koyun

kolye

oyun

kaykay

yünlü

- ➔ Kaya ekmek ile ye.
- ➔ Nilay Aykut ile otlat.
- ➔ Eylül on iki tane mum
- ➔ Oktay kaliteli al.
- ➔ kalk oyun oyna.
- ➔ Oya ninene yelek al.
- ➔ Ayten yem atma.
- ➔ Kaya eliyle tuttu.
- ➔ Atalay ile kay.
- ➔ Aylin ona tak.



☞ Metni okuyalım. Aşağıya yazalım.

MAYMUN

Leyla o 1 maymun.

O maymun komik maymun.

Maymuna yem koyma.

Leyla maymun ile oyna.

O maymun yetenekli.



Blank writing area with a dashed line for tracing.

Blank writing area with a dashed line for tracing.

Blank writing area with a dashed line for tracing.

Blank writing area with a dashed line for tracing.

Blank writing area with a dashed line for tracing.

Blank writing area with a dashed line for tracing.



☞ Cümleleri okuyalım. Soruları cevaplayalım.

Kaykayla kayma.

Neyle ?

Oya oyun oyna.

Kim ?

Tülay kaymak ye.

Ne ?

Tilkiyi yakala.

Neyi ?

Nilay'a iyilik et.

Kime ?

Koluna künyeyi tak.

Neyi ?

Ona yeni etek al.

Ne ?

Leyla,kolye tak.

Kim ?

Kaya ile oyna.

Kimle ?

İlkay yem at.

Ne ?

Oktay koyun otlat.

Ne ?

Yaman elma ye.

Kim ?

Bulmacayı çözelim.

The crossword puzzle grid is composed of yellow squares. The clues are as follows:

- Monkey (top right)
- Road (top left)
- Crescent moon (left)
- Stork (left)
- Sheep (left)
- Truck (left)
- Bed (left)
- Mirror (left)
- Skateboard (middle)
- Swimsuit (middle)
- Lace collar (right)
- Spring (right)

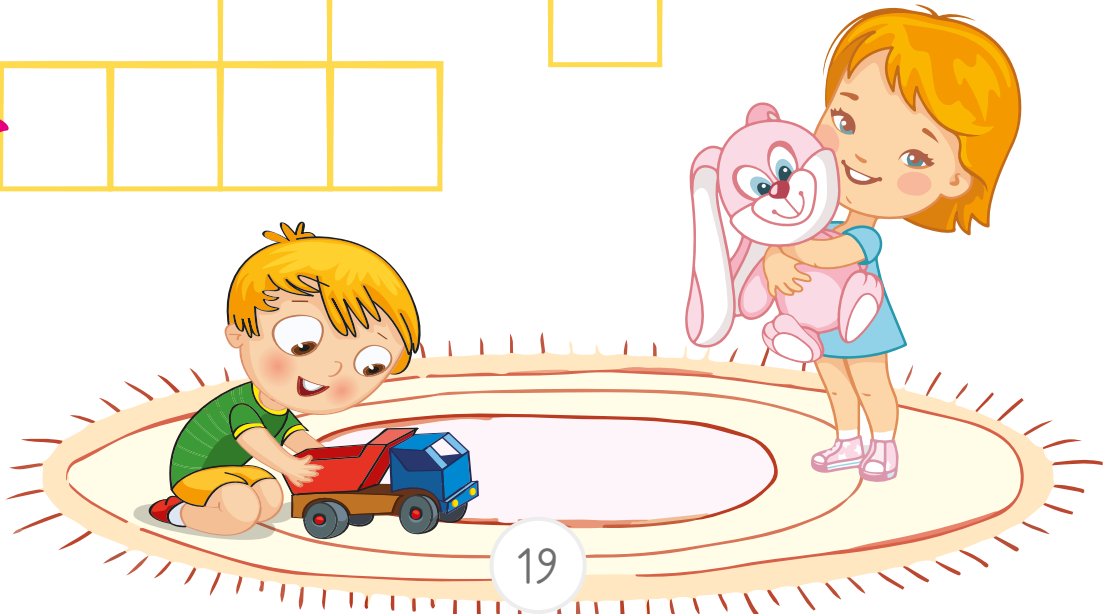



Resfebe etkinliğini yapalım.

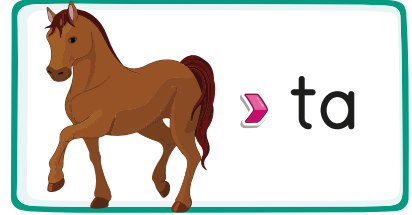
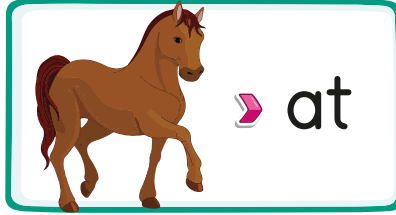
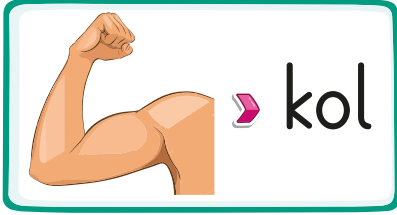
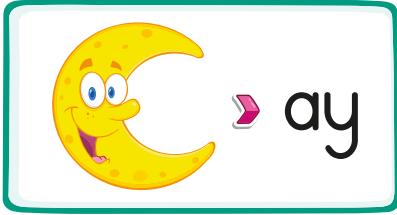

--	--	--	--



--	--	--	--	--	--



--	--	--	--

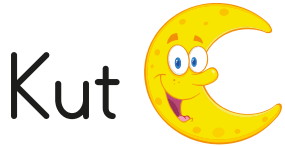

--	--	--	--	--

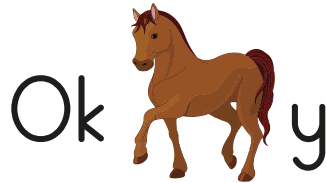

--	--	--	--	--

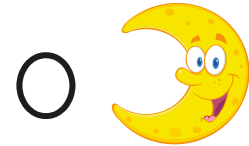

--	--	--

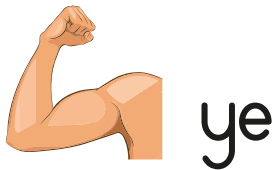

--	--	--	--	--

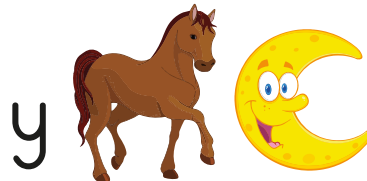

--	--	--	--	--

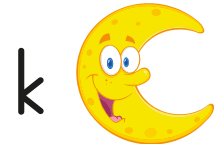

--	--	--



--	--	--	--

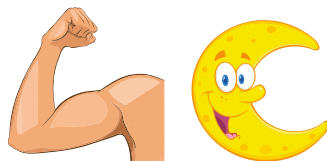

--	--	--	--	--



--	--	--

Yönergeleri uygulayalım.

- Kız isimlerini sayfanın aşağısından kesip yapıştıralım.

- Erkek isimlerini sayfanın aşağısından kesip yapıştıralım.



- Adında en çok "y" sesi olan görseli boyayalım.

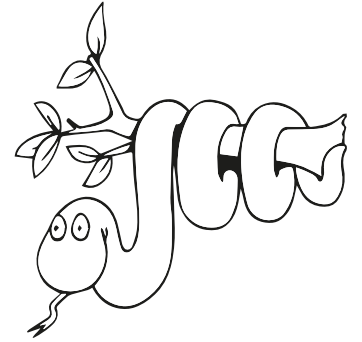
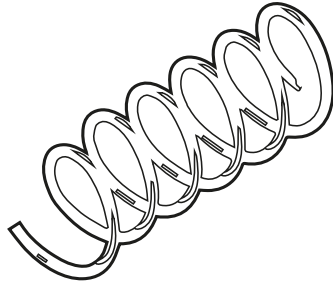

- Büyük "Y" yazalım.

- Küçük "y" yazalım.

Blank writing area for the uppercase letter 'Y'.

Blank writing area for the lowercase letter 'y'.

Blank writing area for the uppercase letter 'Y'.

Blank writing area for the lowercase letter 'y'.

Oktay

Oya

Kaya

Yekta

Eylül

Aylin

MATEMATİK

1

2

3

4

5

6

7

8

+

-

9

0

÷

×

=

?



Varlıkları sayalım. 10'dan az ise ↓, 10'dan çok ise ↑ boyyalım.

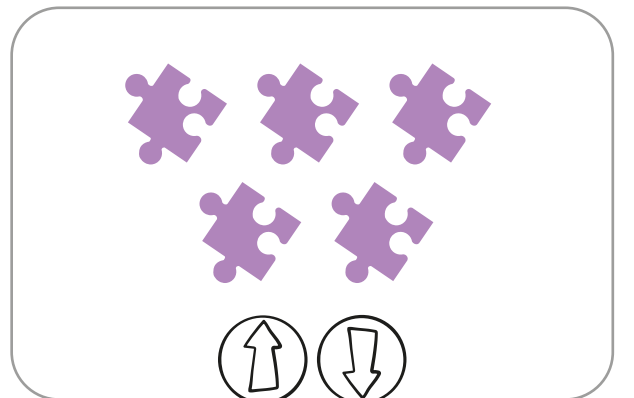
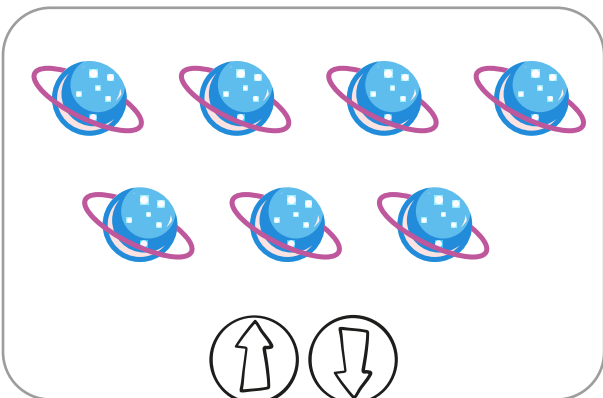
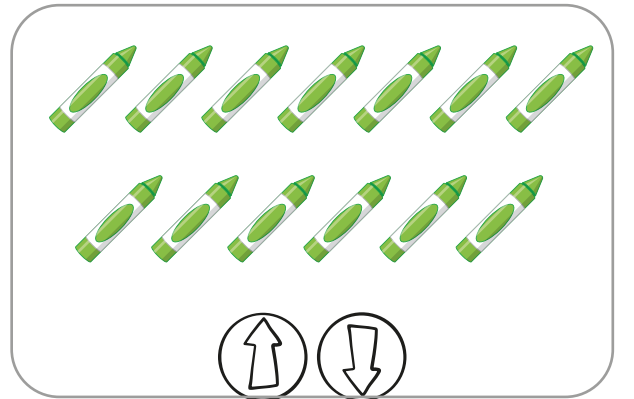
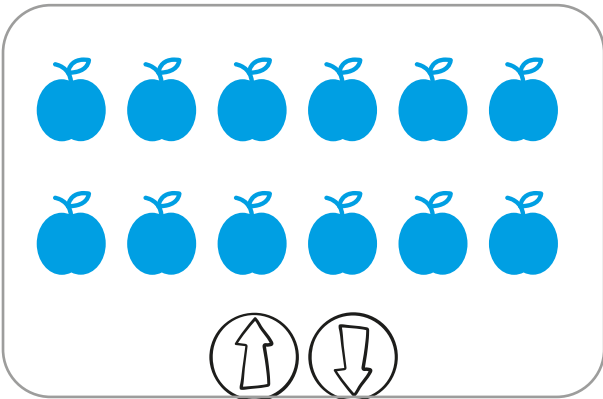
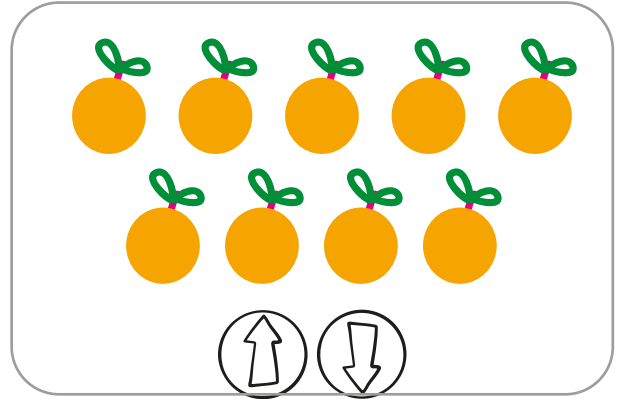
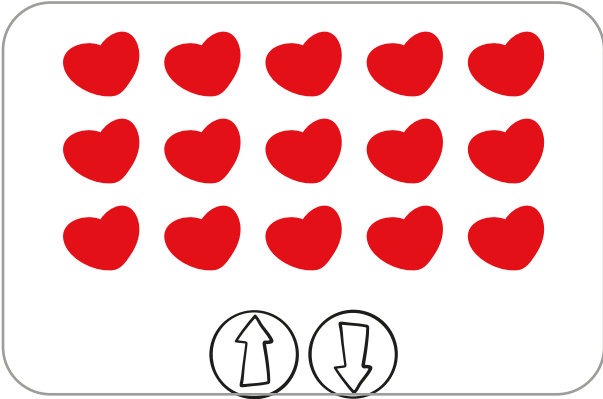
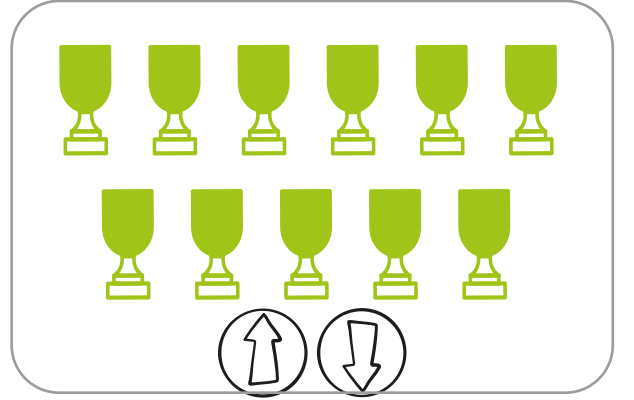
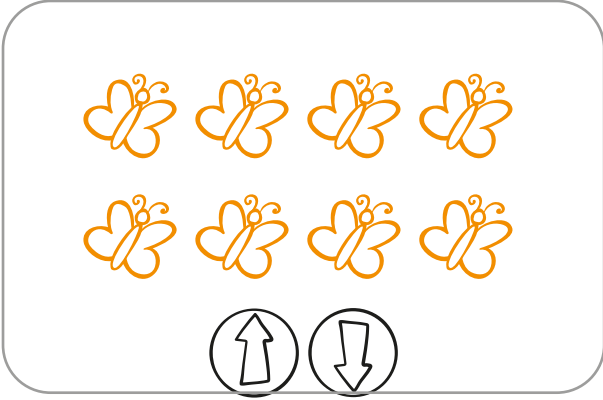



👉 Sayıları 10 ile karşılaştıralım. 10'dan küçük olan sayıların yıldızını boyayalım.

8 12

15 9

10 17

19 7

3 11

2 16

9 13

14 6

20 1

18 4

5 12

19 3

👉 Sayıları 10 ile karşılaştıralım. 10'dan büyük olan sayıların yıldızını boyayalım.

9 16

11 7

3 19

12 6

1 20

14 2

5 13

17 8

10 4

16 2

15 9

6 18



10'dan büyük olan sayıları yuvarlak içine alalım.

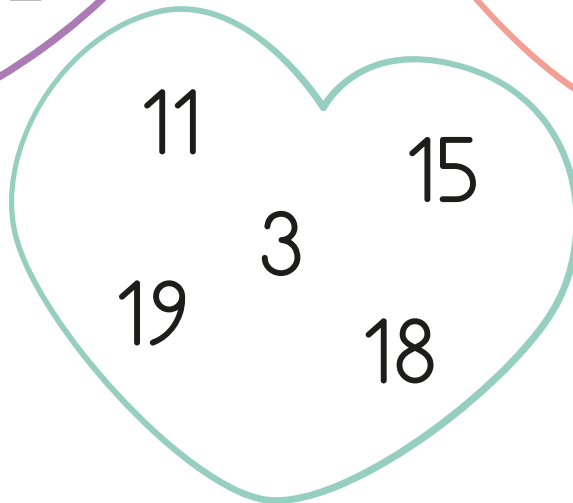
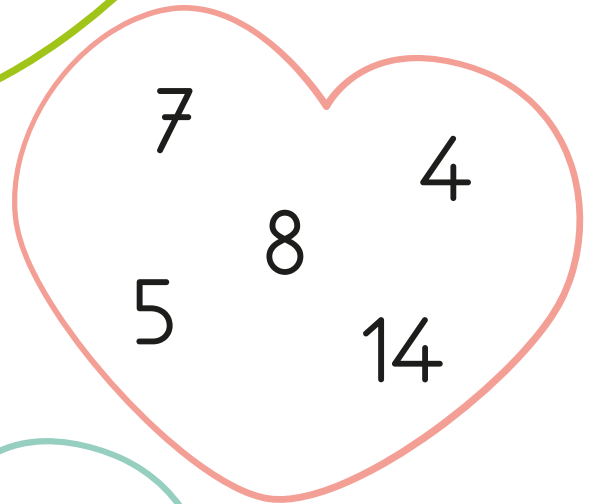
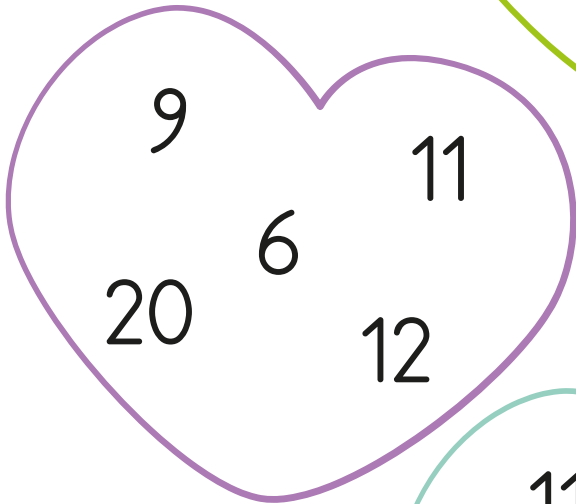
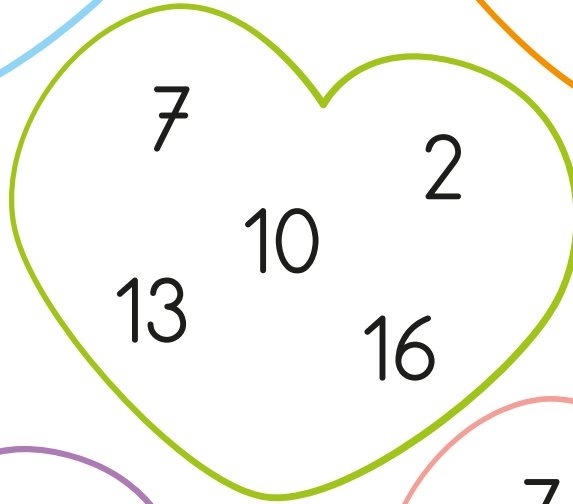
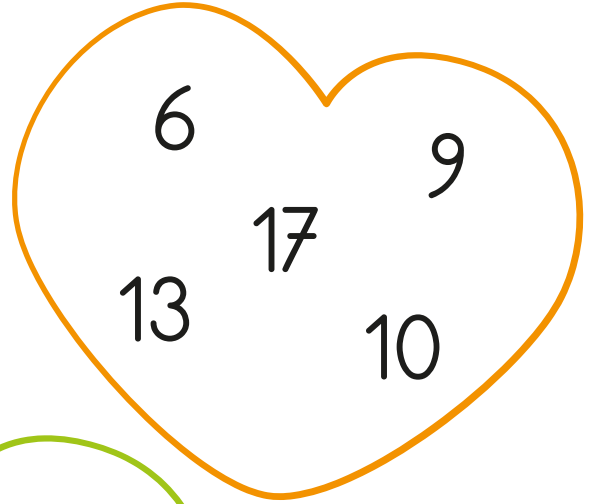
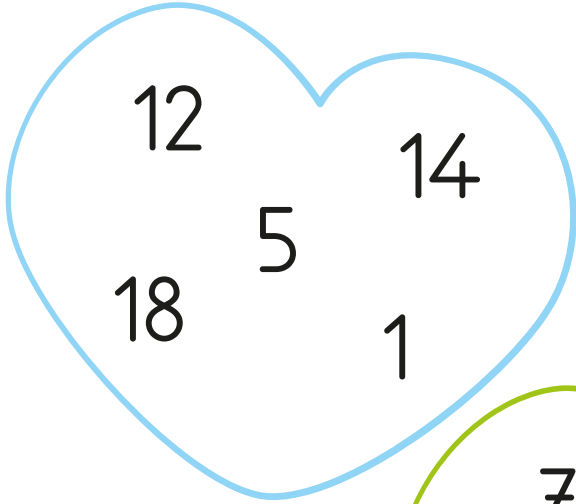



10'dan küçük olan sayıları yuvarlak içine alalım.

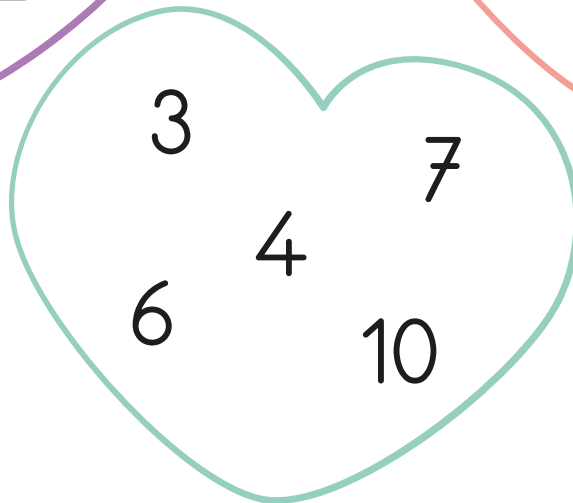
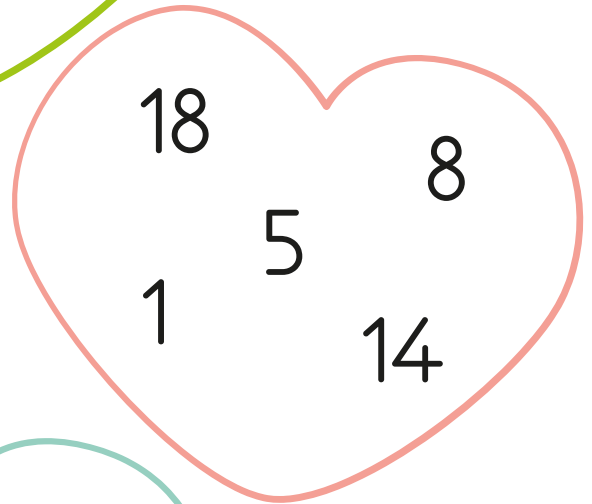
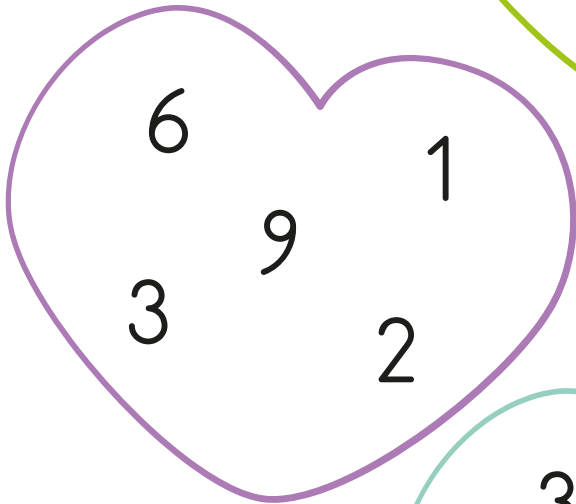
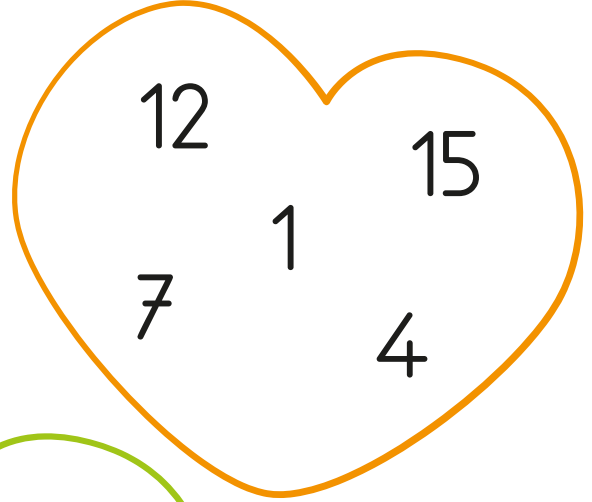
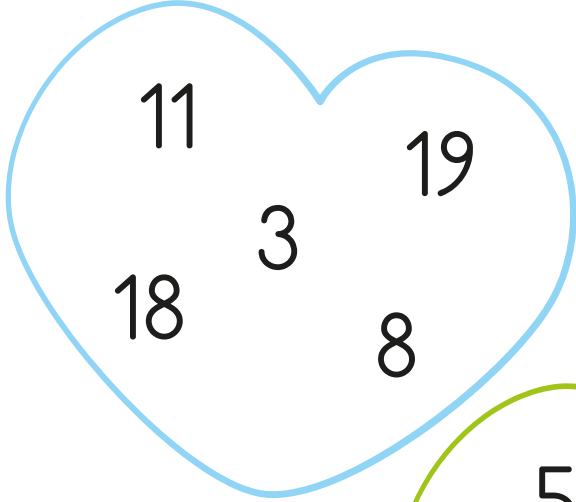



👉 10'dan küçük olan sayıların balonunu boyyalım.

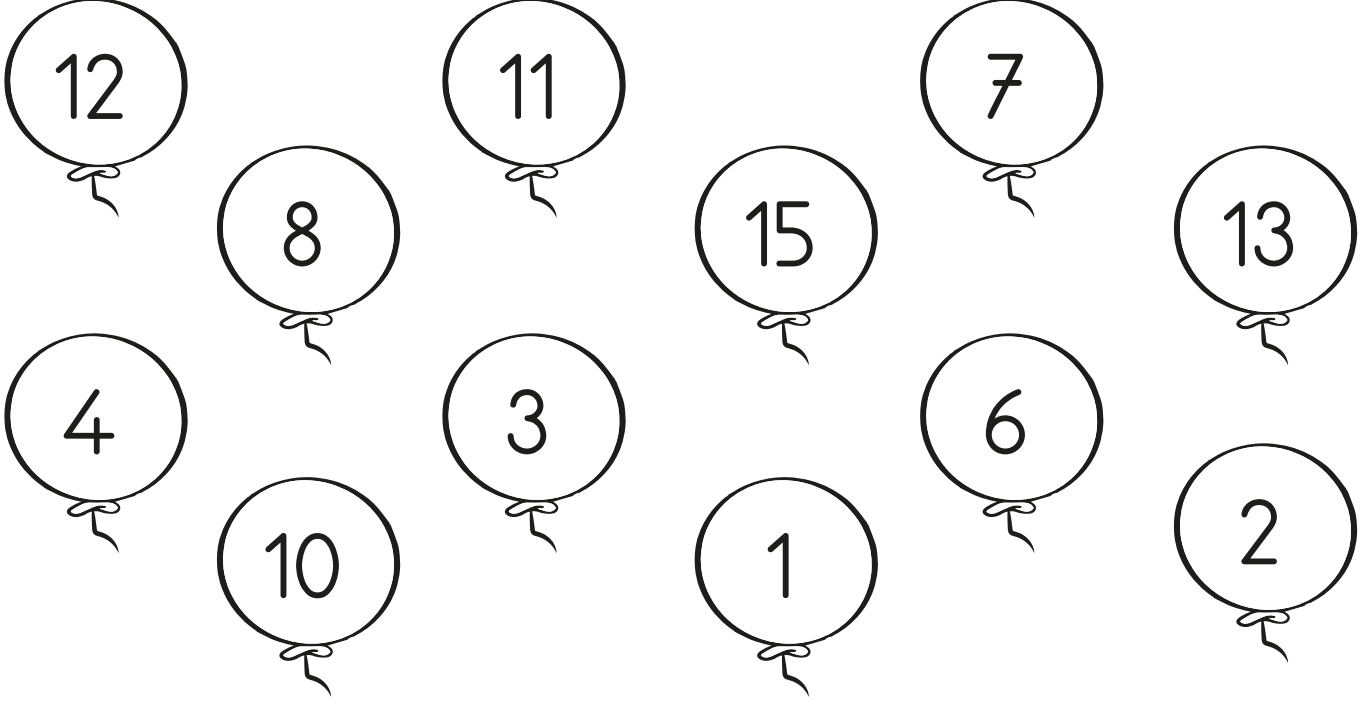

👉 10'dan büyük olan sayıların balonunu boyyalım.

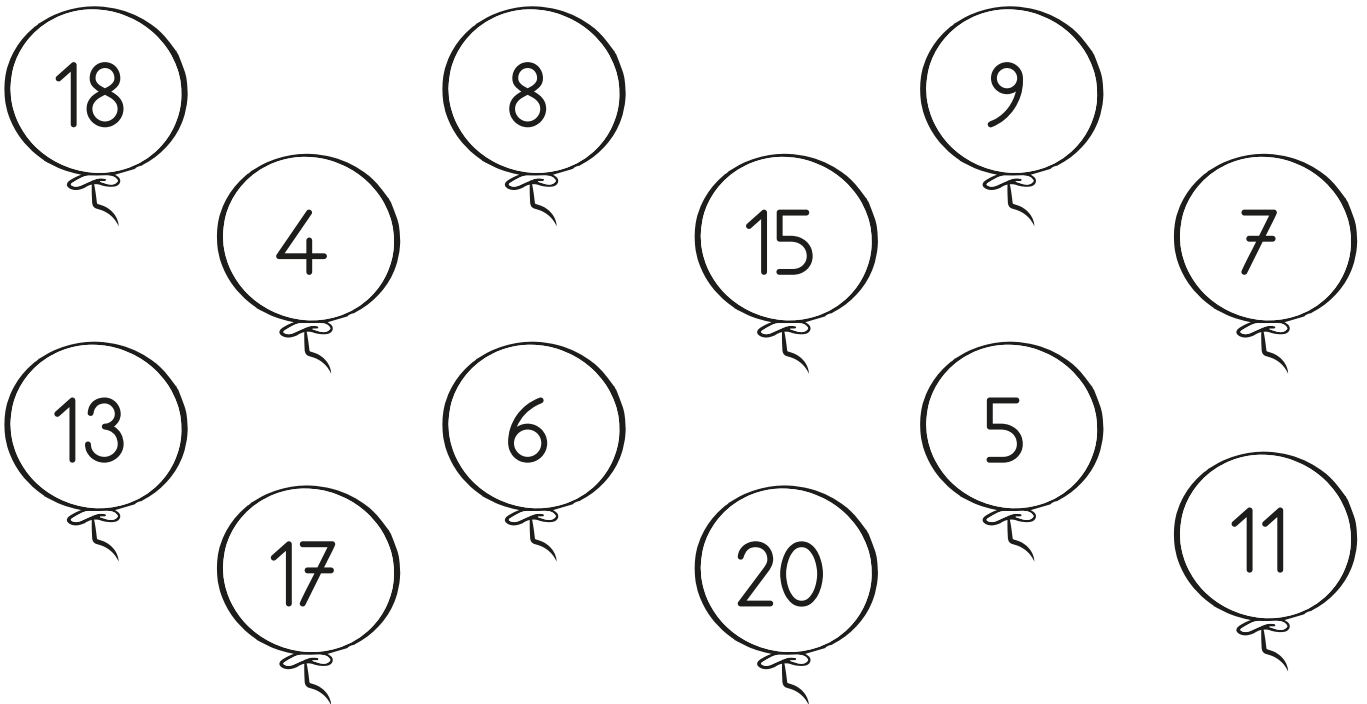



 Yönergeleri uygulayalım.

 Kutulara 10'dan daha az top çizelim.

--

--

--

--

 Kutulara 10'dan daha çok top çizelim.

--

--

--

--

 10'dan küçük 5 sayı yazalım.

--	--	--	--	--

 10'dan büyük 5 sayı yazalım.

--	--	--	--	--



 Sayıları kesip uygun kutulara yapıştıralım.



16	2	12	5	15	4
9	13	7	18	1	8
19	6	14	3	17	11

10'dan büyük

10'dan küçük



10'dan büyük sayıları yeşile boyayalım.

10'dan küçük sayıları kahverengiye boyayalım.

	15	13	11	14	19	16	14	3		
11	1	2	18	17	19	12	6	13	12	
	19	18	7	15	13	7	15	11	16	
		14	9	16	2	19	1	4	3	14
			12	3	16	6	18	20	11	
				15	5	12				
					8					
					7					
					2					