

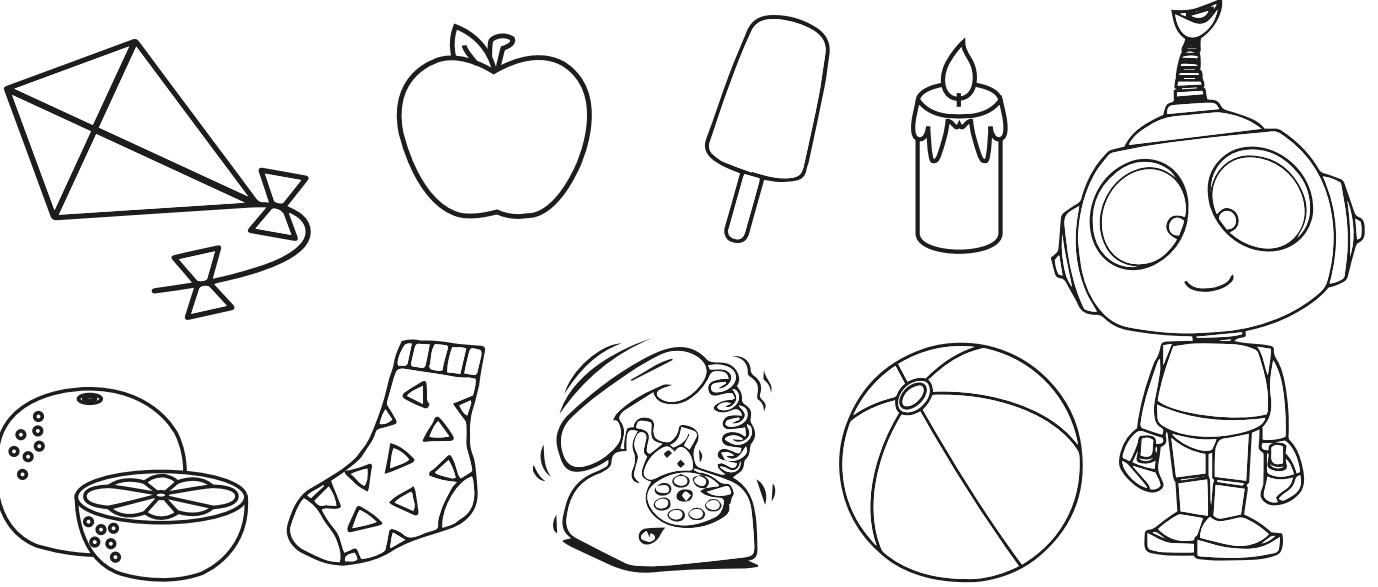

O VE M SESİ ÇALIŞMALARI



👉 Adında "o" sesi bulunan varlıkları boyayalım.



👉 "o" sesi ile başlayan varlıkları işaretleyelim.





☞ Büyük "O" harfinin yazılış yönüne dikkat edelim. İçinden kalemimizle geçelim.

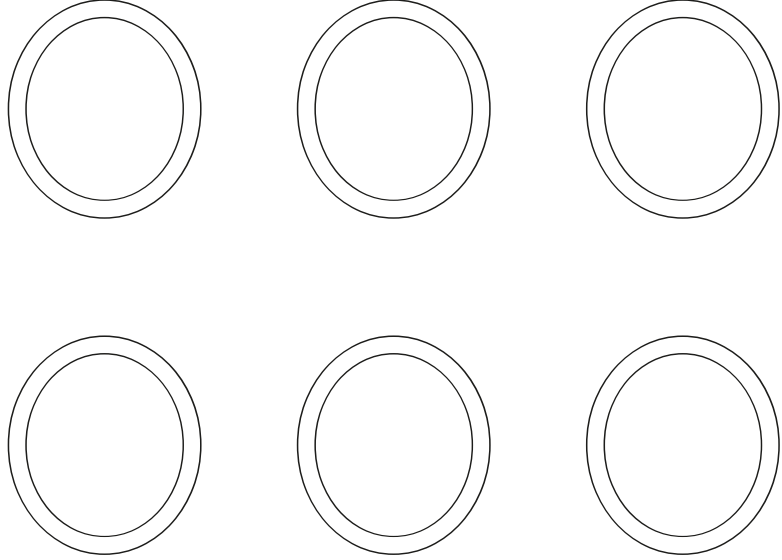
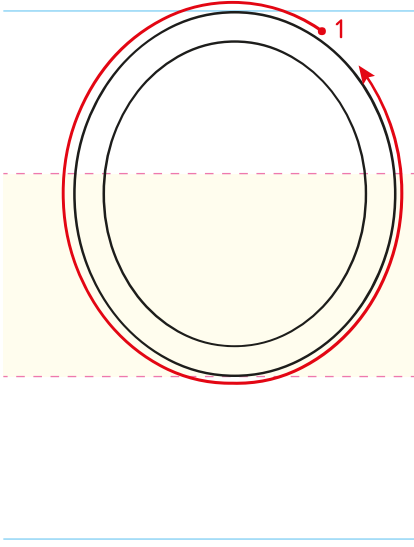

☞ "O" harfinin yazılı olduğu balonları boyayalım.

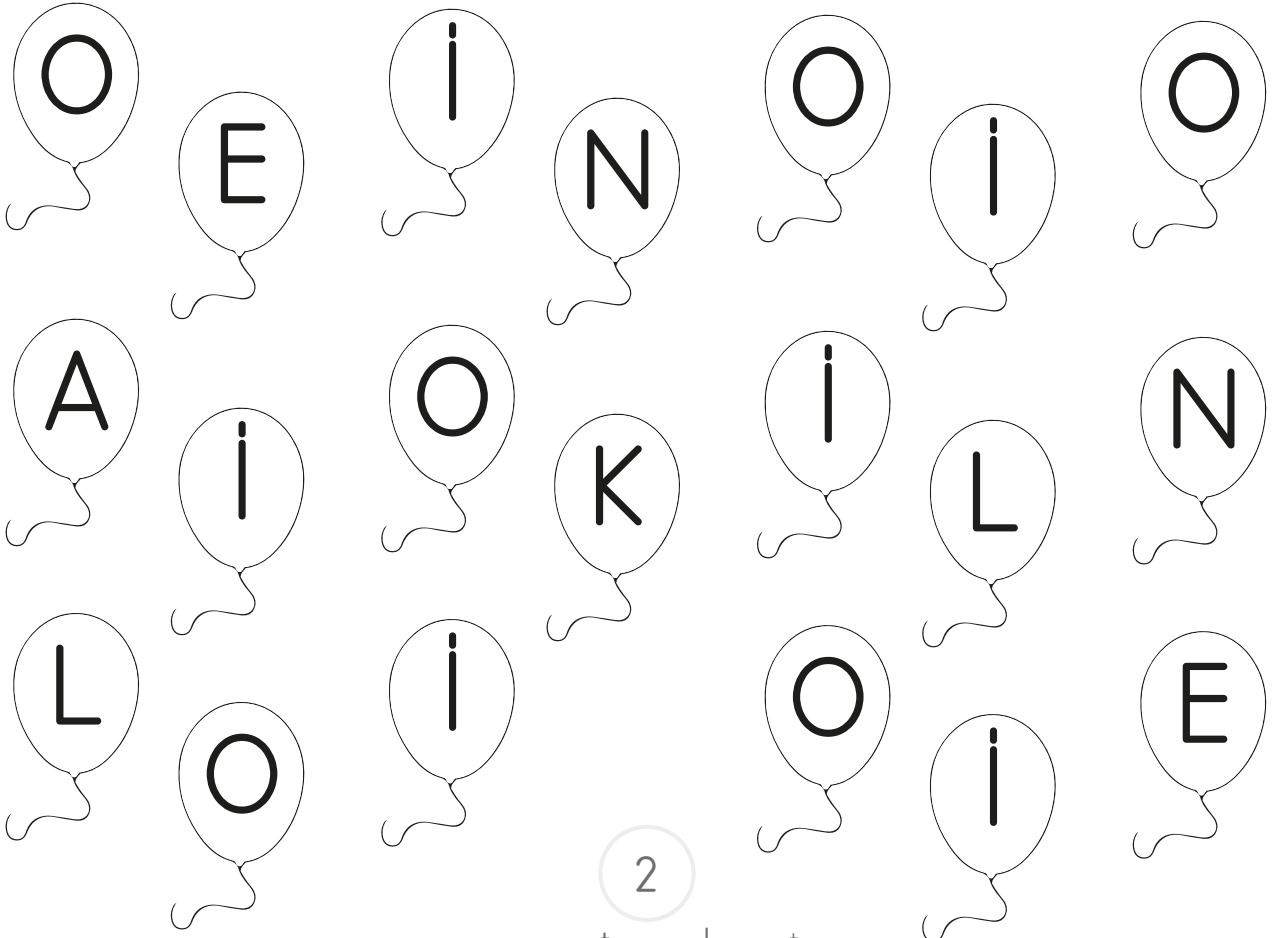

Yönergeleri uygulayalım.

• "O" harfini boyayalım.

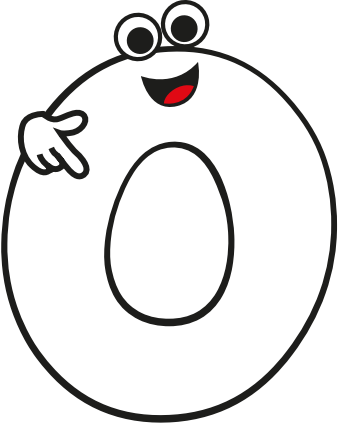

• "O" harflerini bulup yuvarlak içine alalım.



• Noktaları birleştirelim.

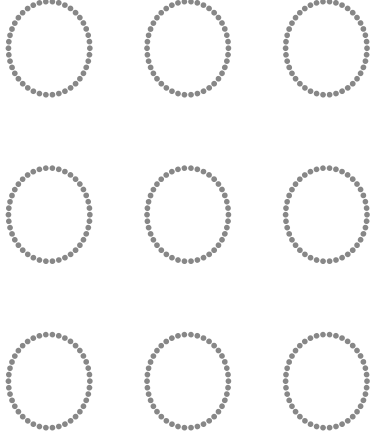

Yazma yönlerine dikkat ederek "O" harfini yazalım.

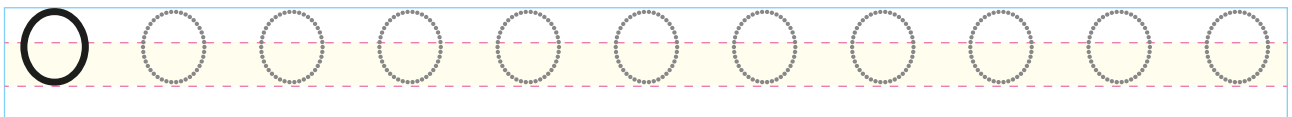
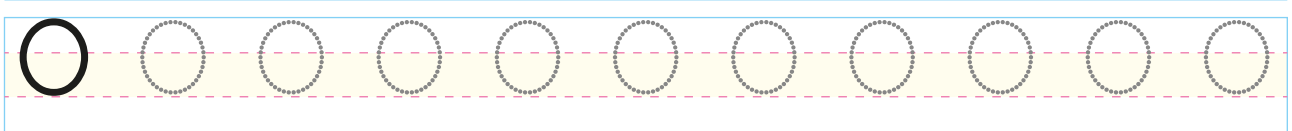
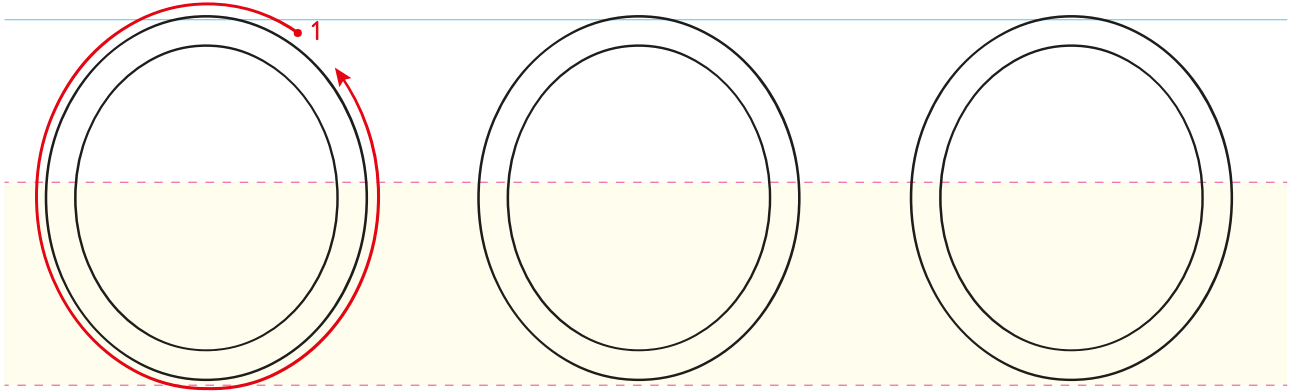



👉 "o" harfini yazalım.

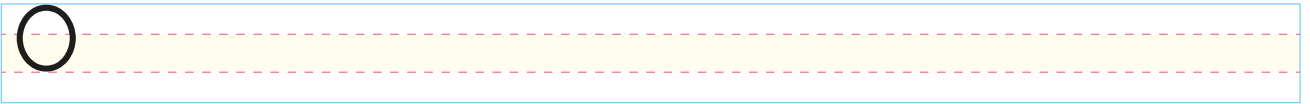
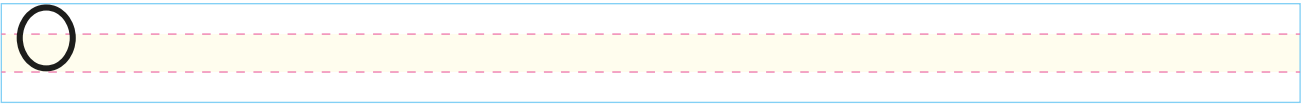
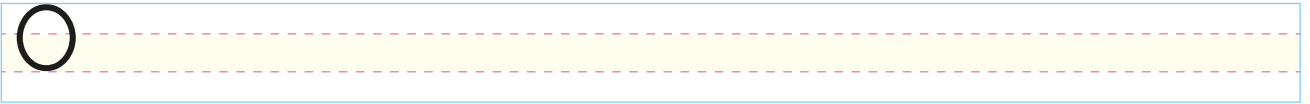
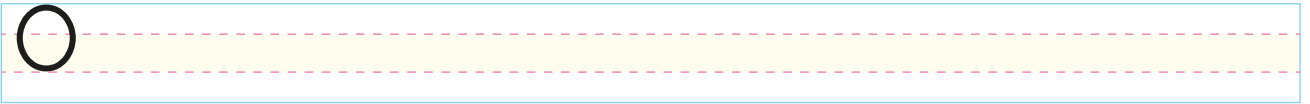
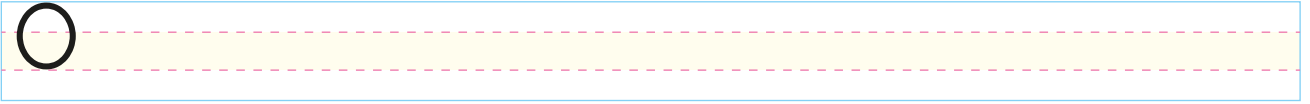
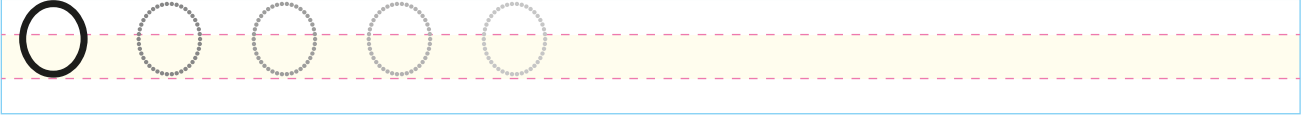
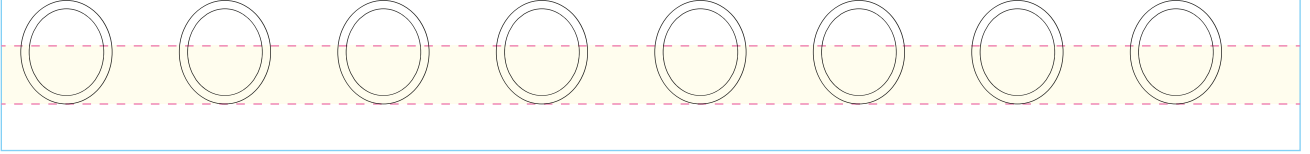



☞ Küçük "o" harfinin yazılış yönüne dikkat edelim. İçinden kalemimizle geçelim.

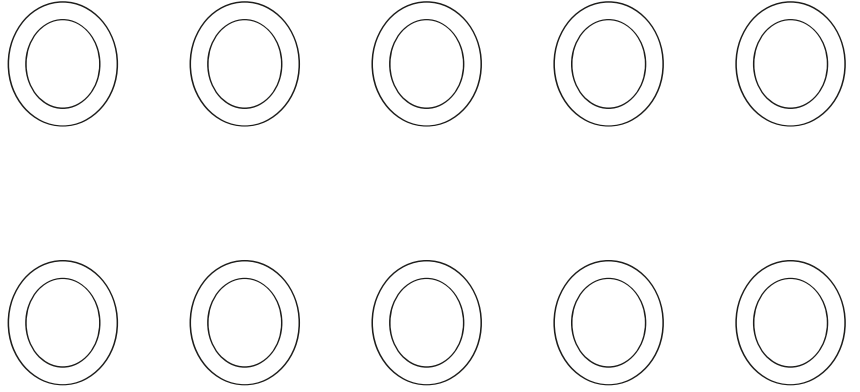
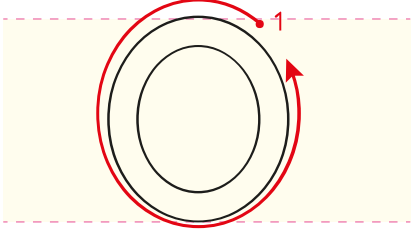

☞ "o" harfinin yazılı olduğu yıldızları boyayalım.



Yönergeleri uygulayalım.

• "o" harfini boyayalım.

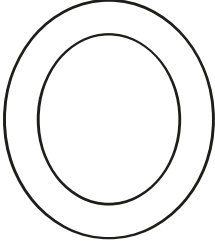

• "o" harflerini bulup yuvarlak içine alalım.

o n k o
i o k
p n l o
i o j

• Noktaları birleştirelim.

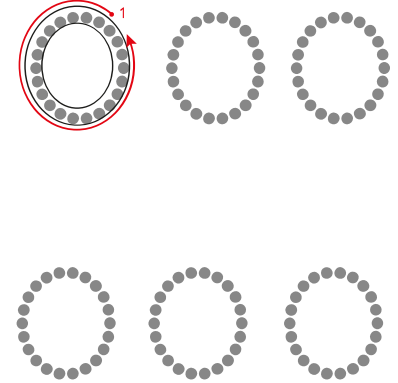

Yazma yönlerine dikkat ederek "o" harfini yazalım.

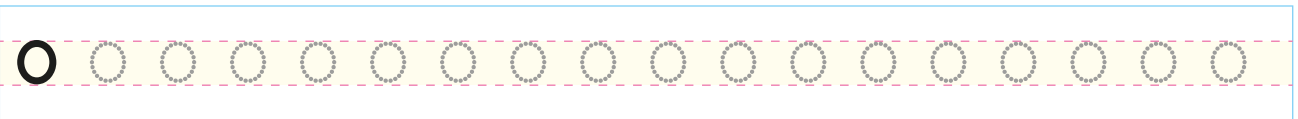
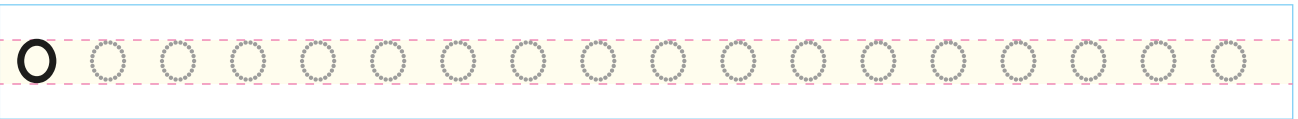
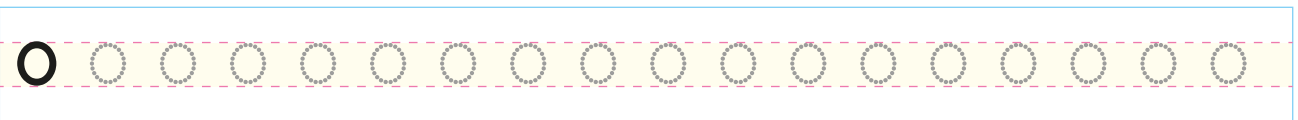
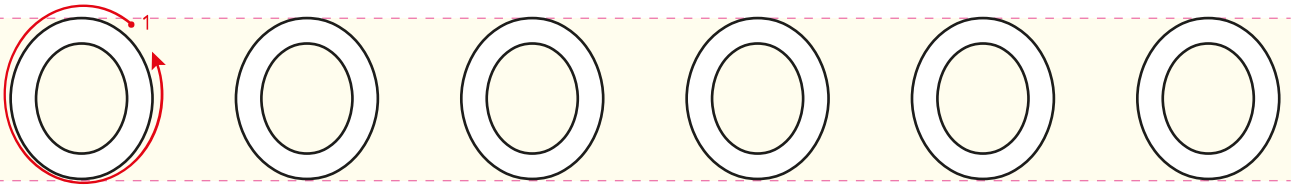



👉 "o" harfini yazalım.

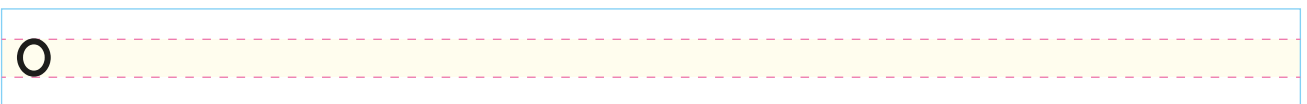
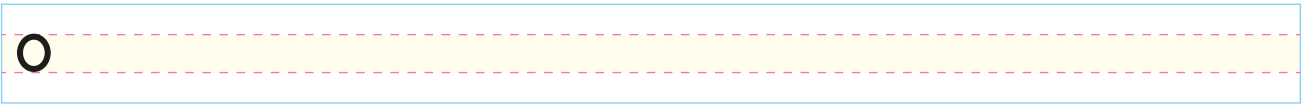
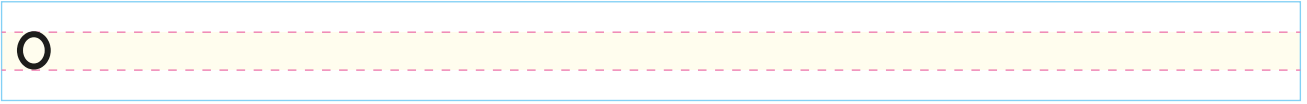
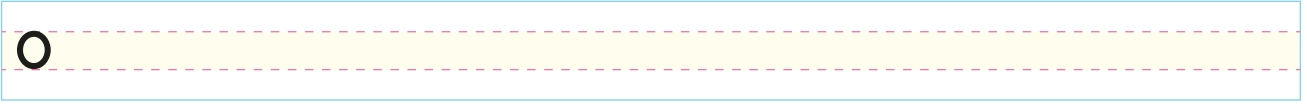
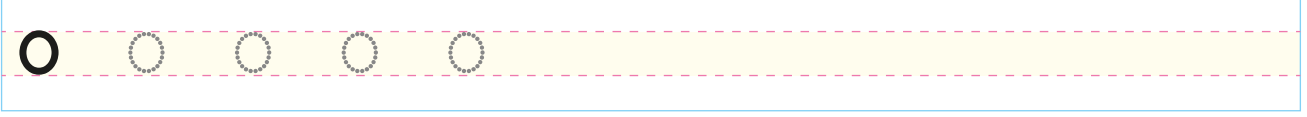
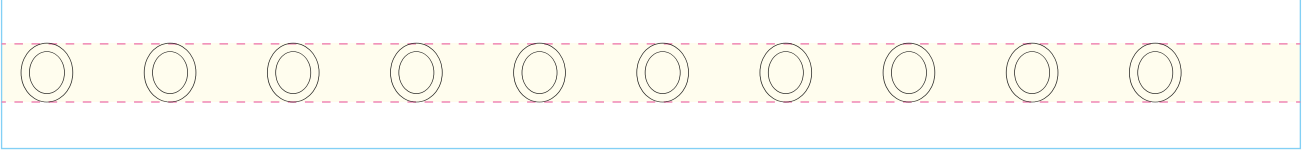



👉 Renklere dikkat ederek görseli boyayalım.

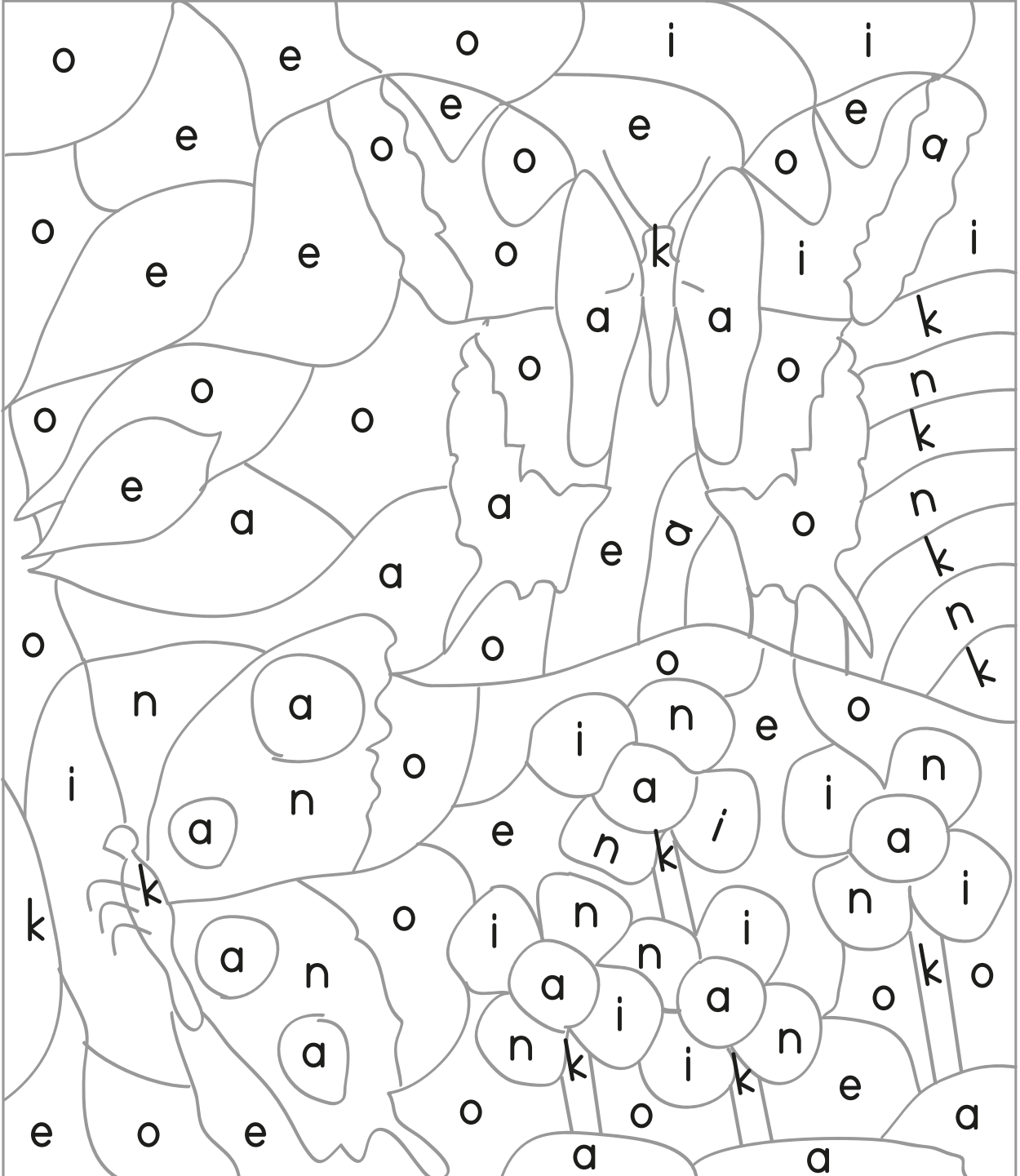
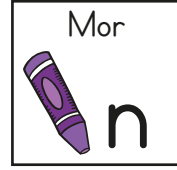
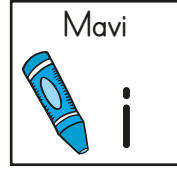
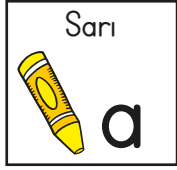



👉 Büyük "O" ve küçük "o" harfini yazalım.

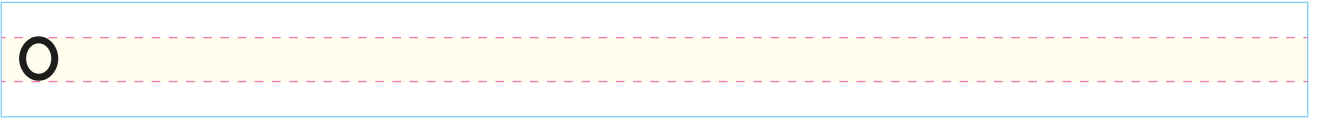
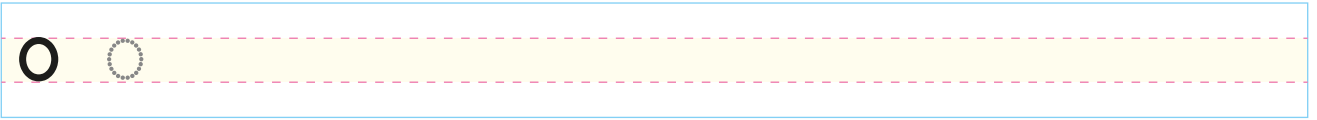
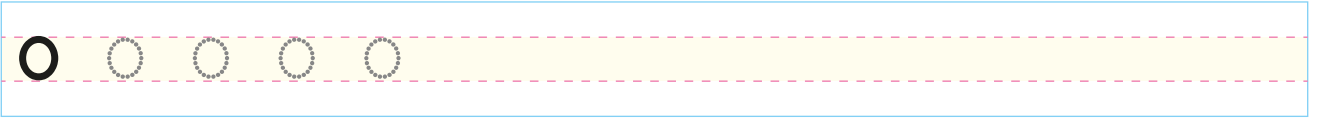
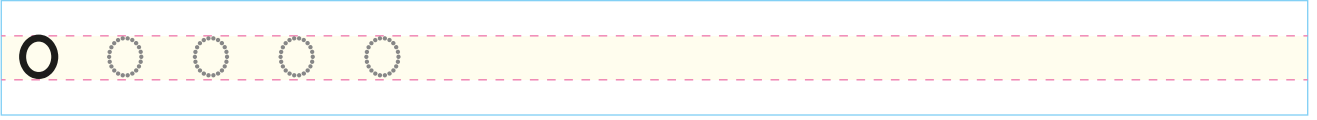
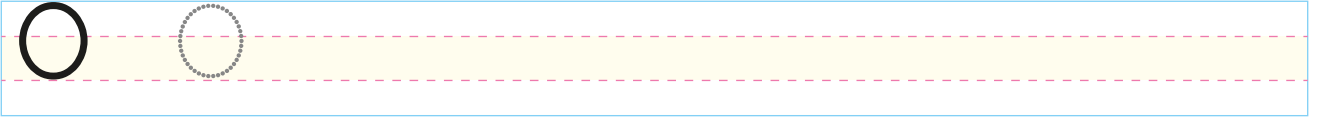
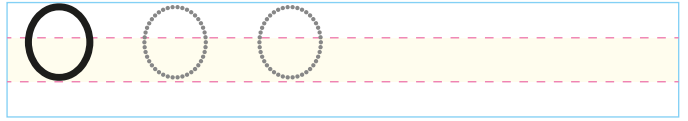
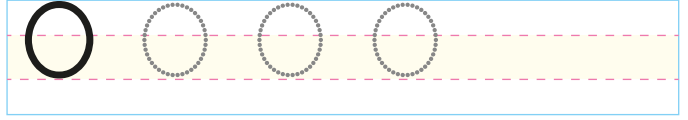
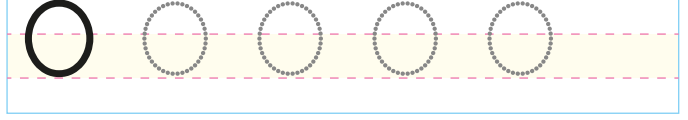
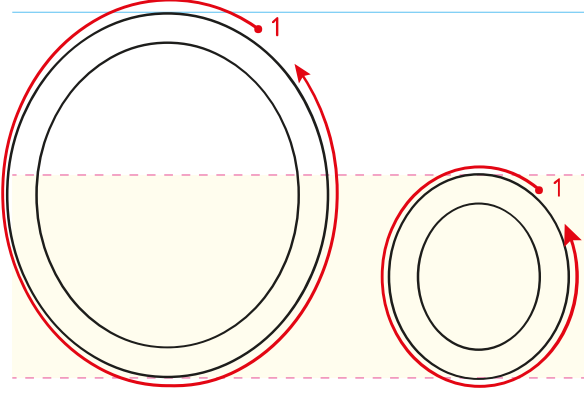



Okuyalım, yazalım.

o l ol ol ol ol

ol

ol

o k ok ok ok ok

ok

ok

o n on on on on

on

on

n o no no no no

no

no



Okuyalım, yazalım.

l o lo lo lo lo

lo

k o ko ko ko

ko

n o no no no

no

ko l kol kol kol

kol

ko n kon kon kon

kon

ko k kok kok kok

kok



Okuyalım, yazalım.

O kan Okan Okan Okan

Okan

ko li koli koli koli

koli

ko ni koni koni koni

koni

Okan koli al.

Okan o koni.



Okuyalım, yazalım.

a lo o na

ki lo ka no

ko nak kok la

ko la ko lon

ok ka ka non

Okuyalım, görseli boyayalım.

Ona iki kilo nane al.

Okan nane kokla.

Okan ile kol kola.

Kokla Okan, nane kokla.



Okuyalım, yazalım.

o a n k

n O a k

i k o l

a o l

i k l o

o a n

n i o k

l k a k o

Heceleri eşleştirip kelimeler oluşturalım.

ko nak le → kolile

ka li o

ka ka la

Okuyalım, yazalım.

Okan konakla.

İki kilo kolile.

Ona kakao ekle.



☞ Karışık kelimelerden cümleler oluşturup yazalım.

nane

kokla

Okan

on

iki

On

al

koli

koni

on

al

Kenan

al

Okan'a

koni

Ali

konak

al

Nail

laleli

ile

Okan

kola

kol



Okuyalım, yazalım.

KOLİLE

Okan eline koli al.

İki koli al, eline al.

Okan nane ile kek kolile.

On koli nane kolile.

On koli kek kolile.

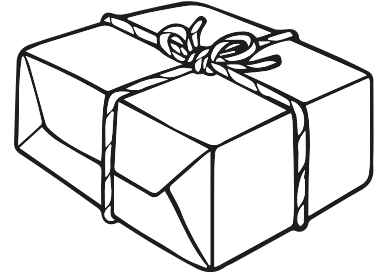
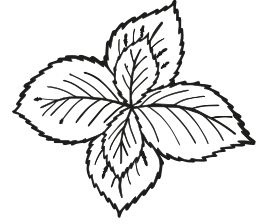

Handwriting practice line with a dashed middle line.

Handwriting practice line with a dashed middle line.

Handwriting practice line with a dashed middle line.

Handwriting practice line with a dashed middle line.

Handwriting practice line with a dashed middle line.

Handwriting practice line with a dashed middle line.

☞ Görseli verilen varlıkların adını yazalım.

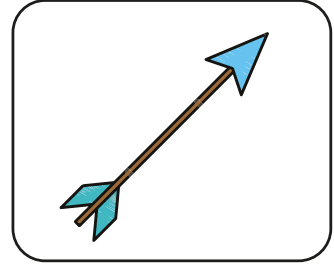
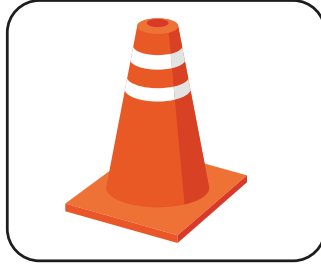

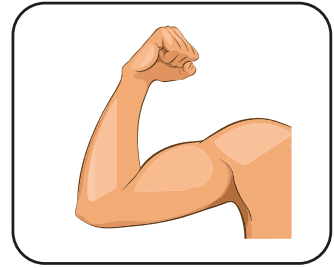
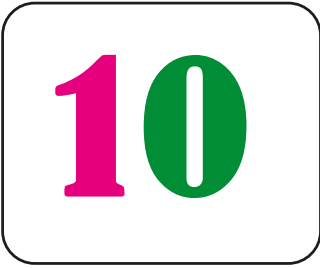

☞ Cümleleri doğru kelimelerle tamamlayalım.

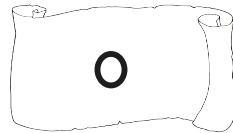

Nail nane _____ .

Okan eline _____ ne?

Kenan iki _____ nane ek.

Ali _____ laleli konak.

Alo Okan _____ .



👉 6 rakamını yazalım.

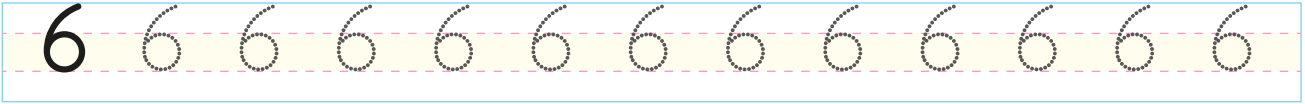
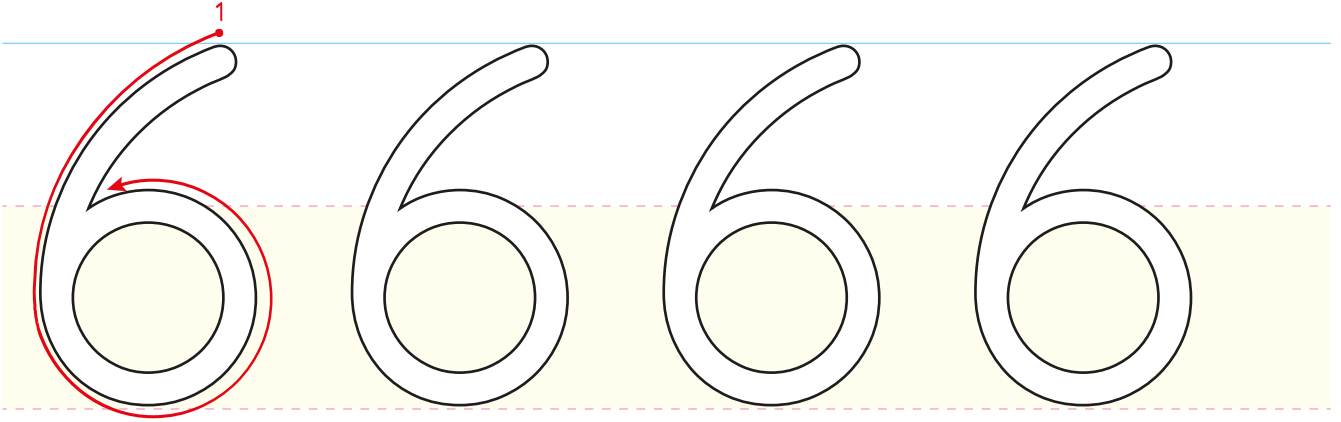



👉 Adında "m" sesi bulunan varlıkları boyayalım.

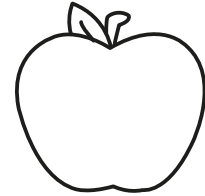
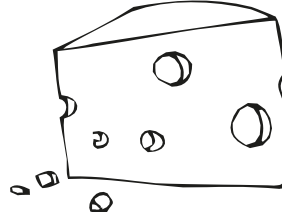
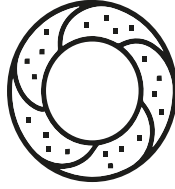
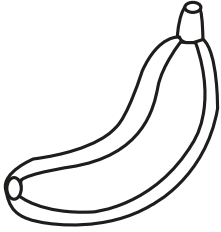
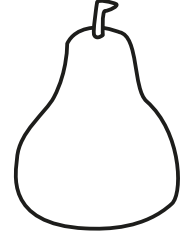
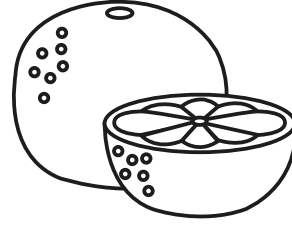

👉 "m" sesi ile başlayan varlıkları işaretleyelim.

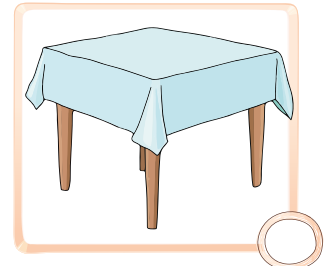
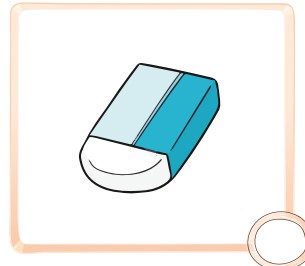
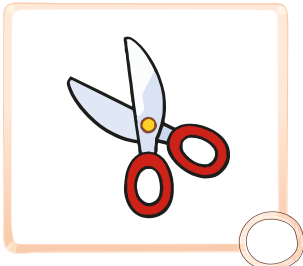
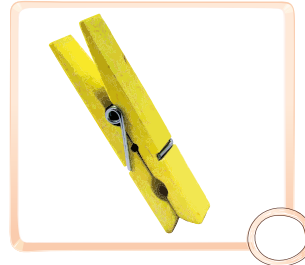
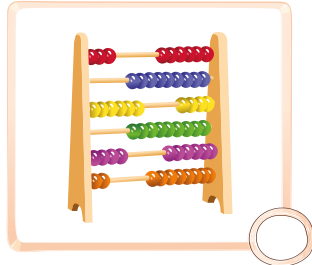
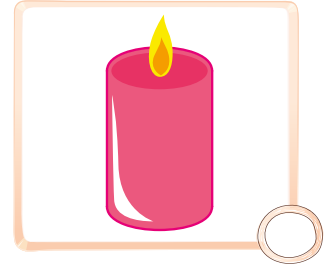
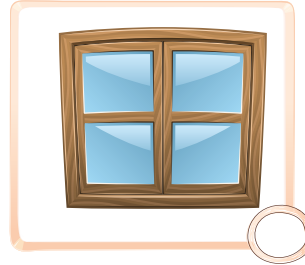
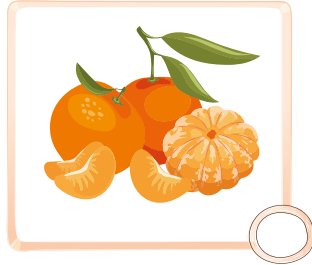
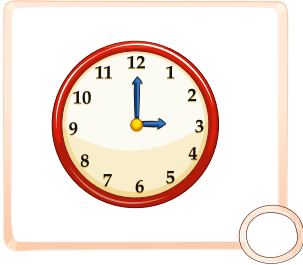



☞ Büyük "M" harfinin yazılış yönüne dikkat edelim. İçinden kalemimizle geçelim.

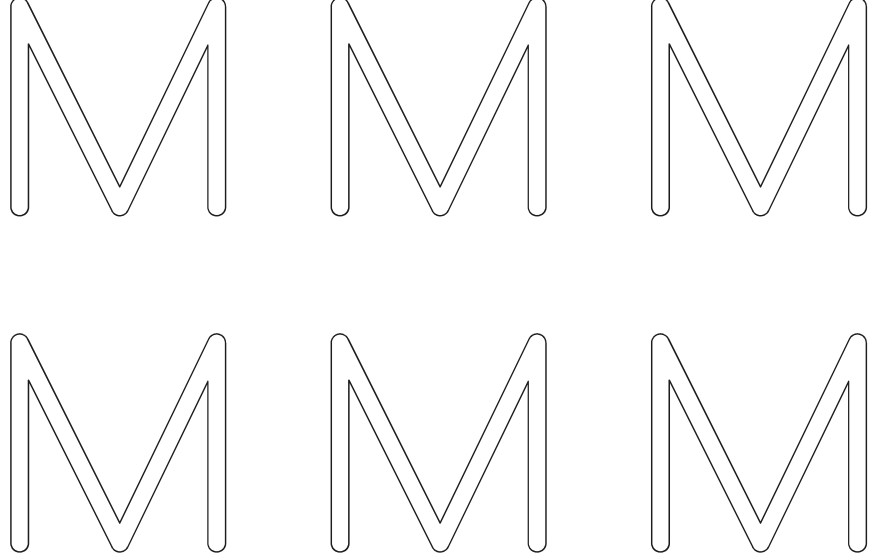
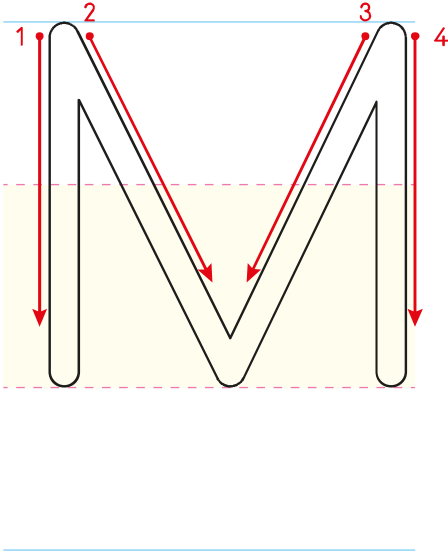

☞ "M" harfinin yazılı olduğu balonları boyayalım.

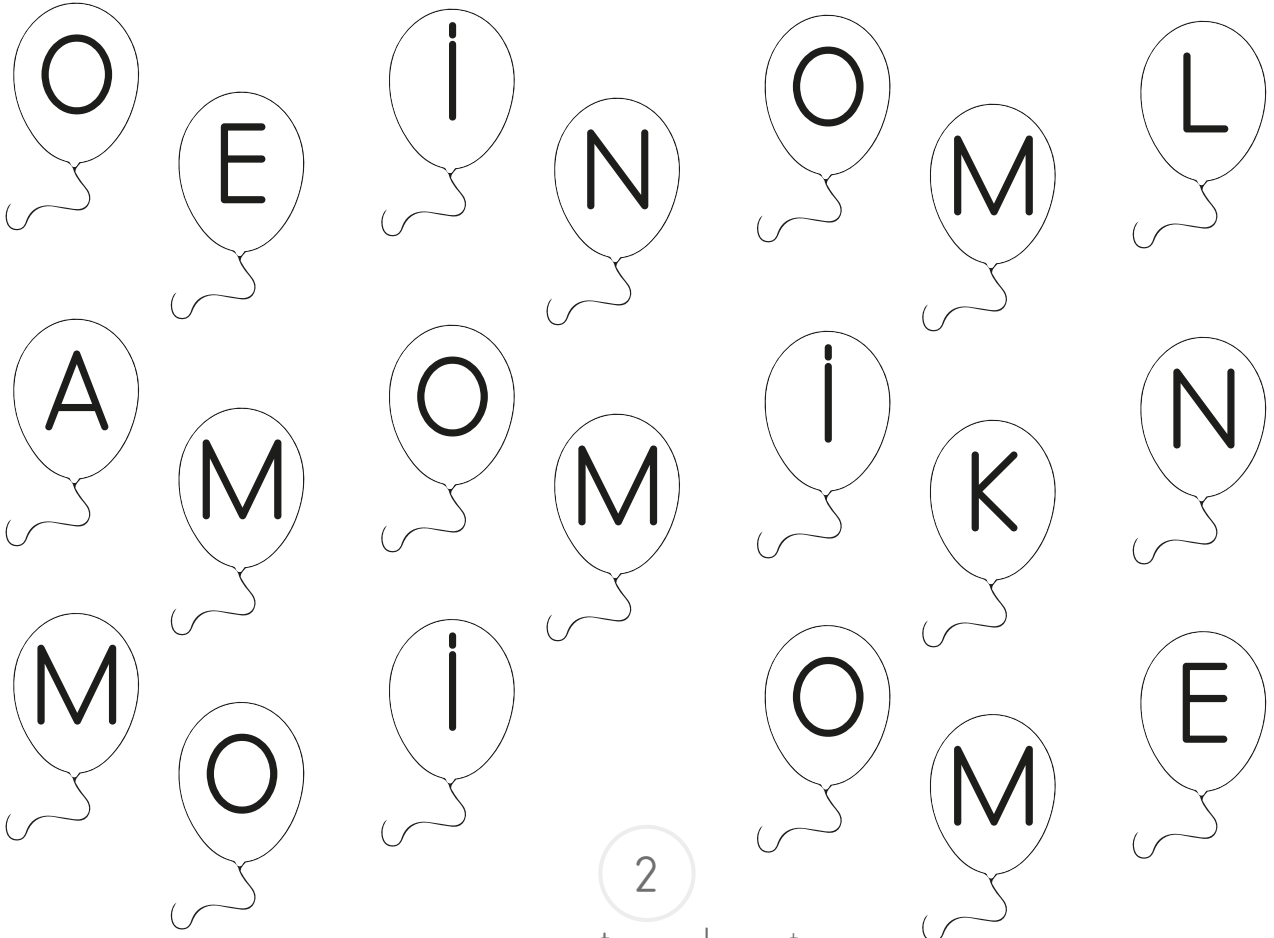

Yönergeleri uygulayalım.

• "M" harfini boyayalım.

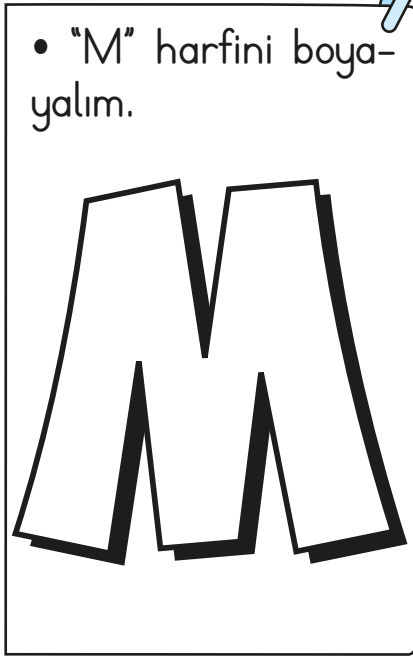

• "M" harflerini bulup yuvarlak içine alalım.

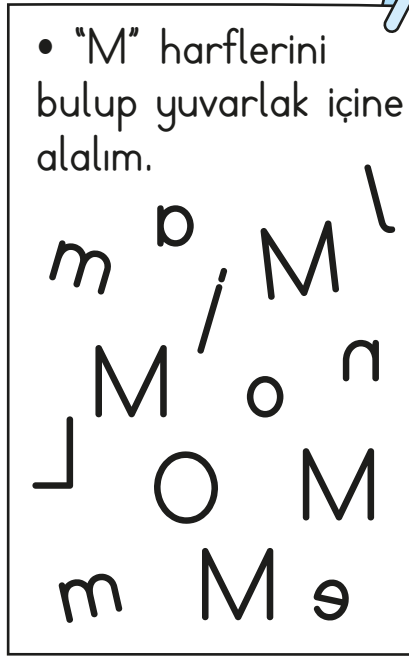

• Noktaları birleştirelim.

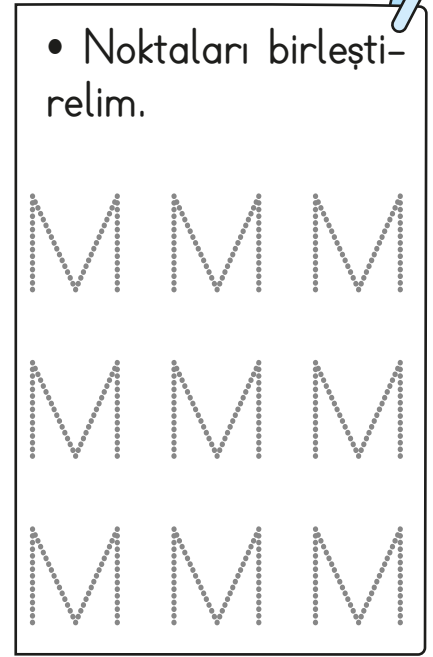

Yazma yönlerine dikkat ederek "M" harfini yazalım.

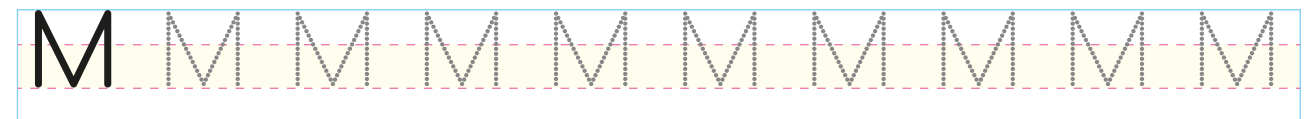
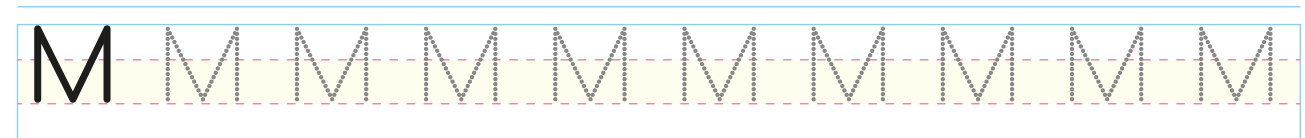
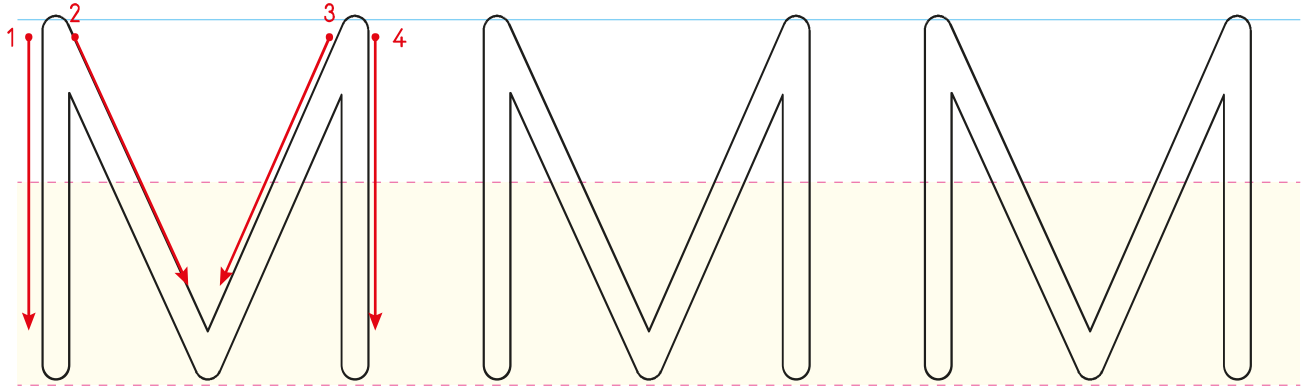



☞ "M" harfini yazalım.

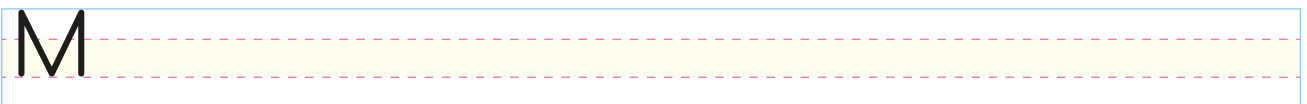
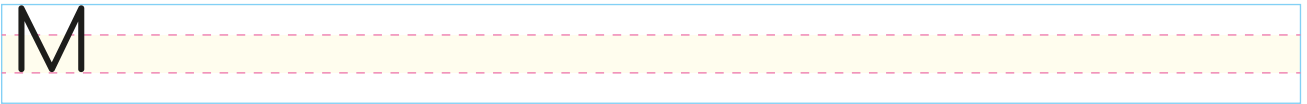
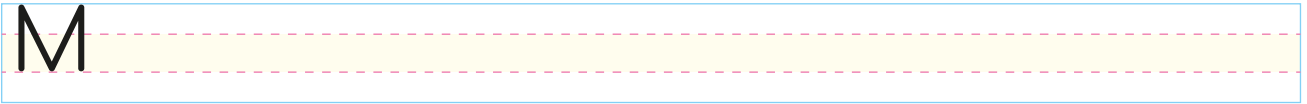
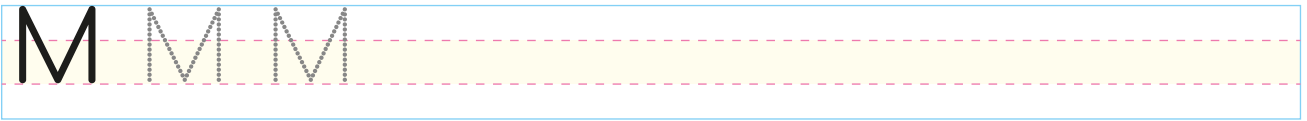
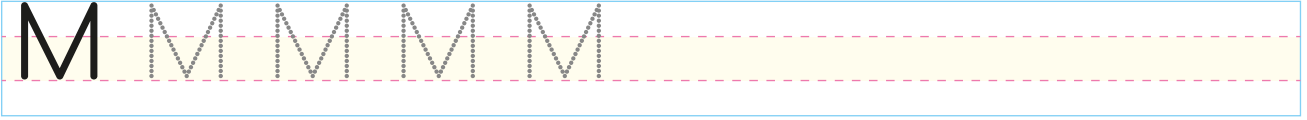
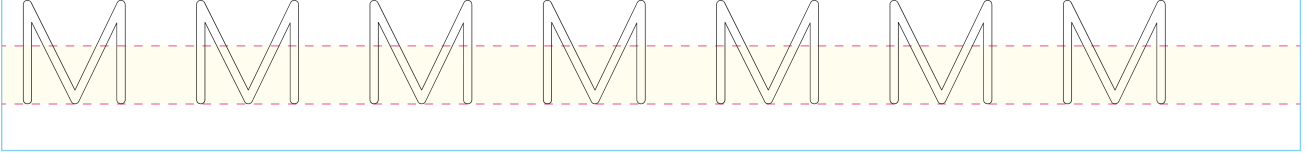



☞ Küçük "m" harfinin yazılış yönüne dikkat edelim. İçinden kalemimizle geçelim.

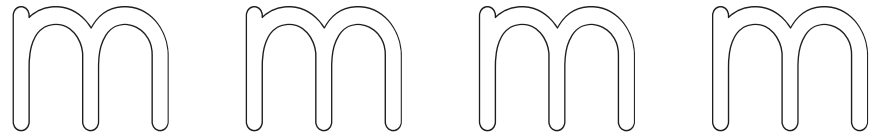
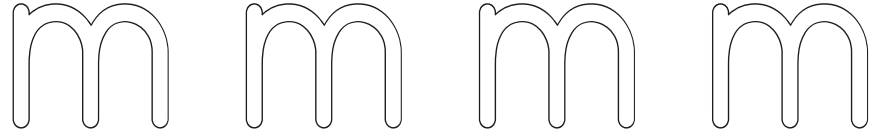
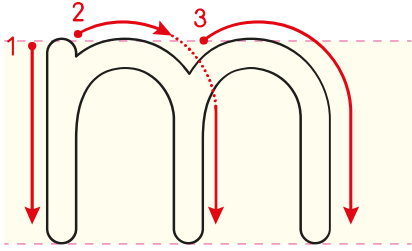

☞ "m" harfinin yazılı olduğu yıldızları boyyalım.



Yönergeleri uygulayalım.

• "m" harfini boyayalım.

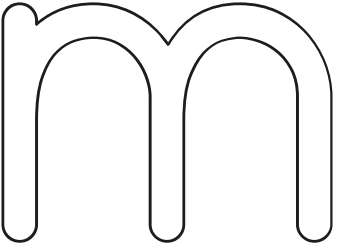

• "m" harflerini bulup yuvarlak içine alalım.

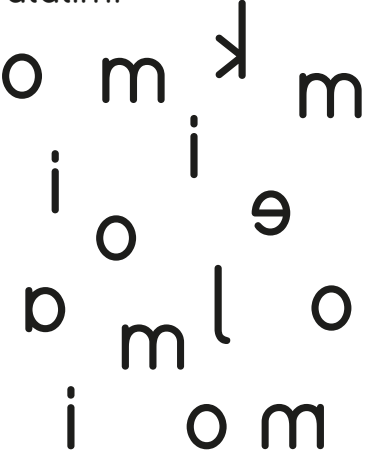

• Noktaları birleştirelim.

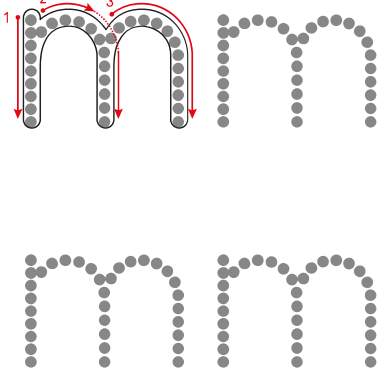

Yazma yönlerine dikkat ederek "m" harfini yazalım.

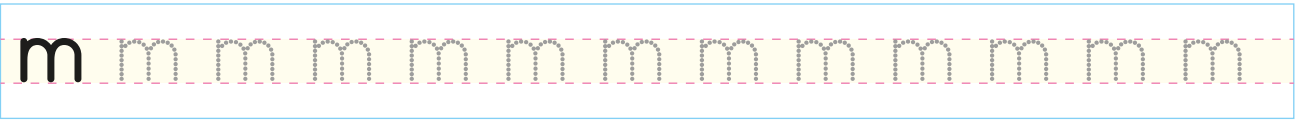
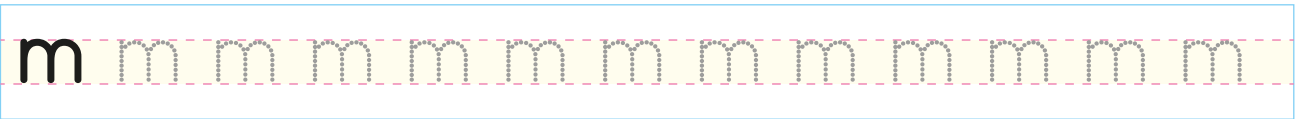
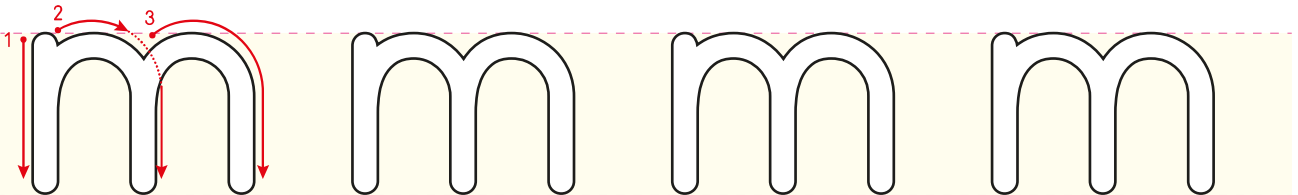



☞ "m" harfini yazalım.

m m m m m m m m m m m m

m m m m m

m m m m

m

m

m

m

m

m

m

m

m



👉 Renklere dikkat ederek görseli boyayalım.

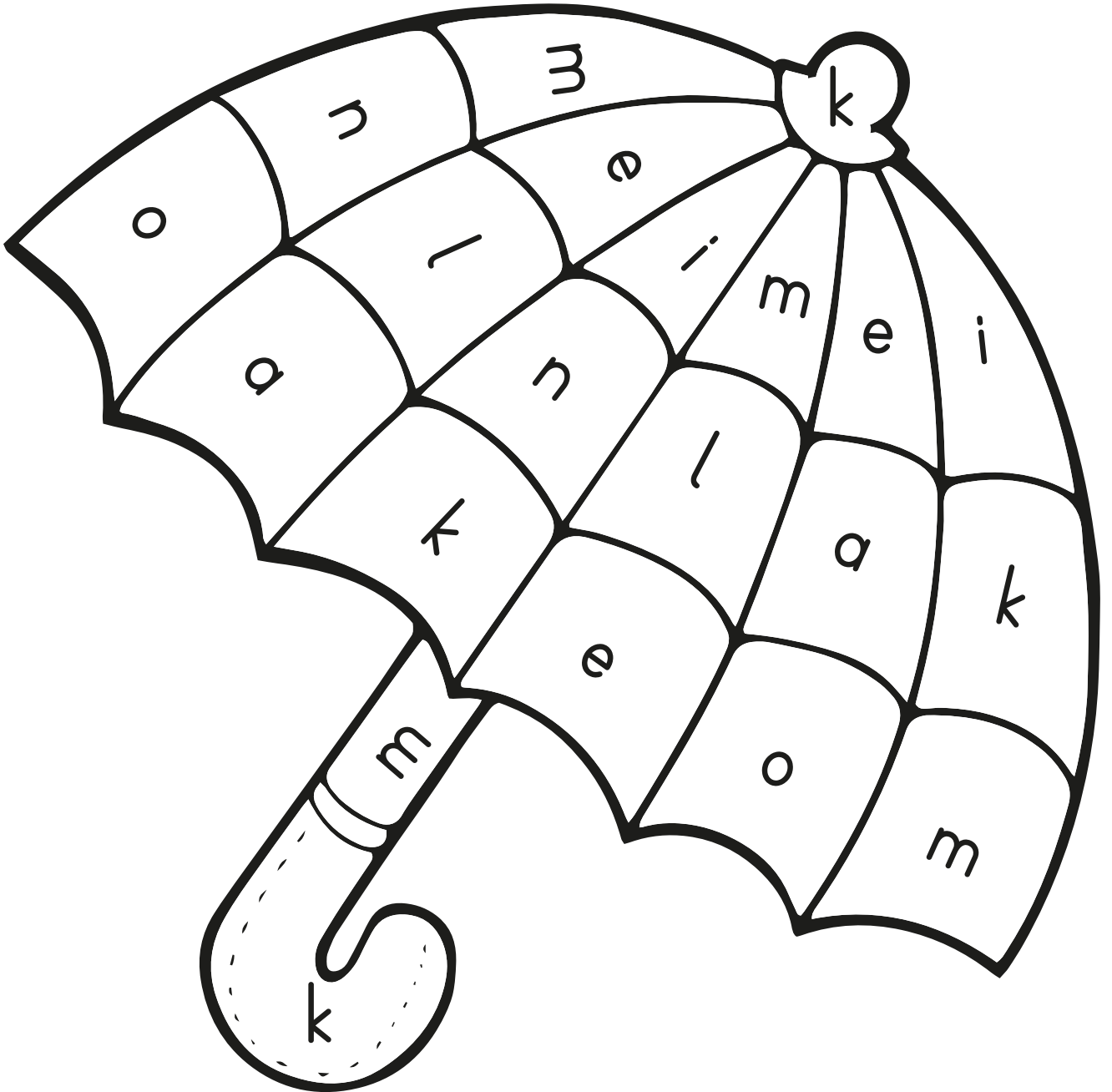



👉 Büyük "M" ve küçük "m" harfini yazalım.

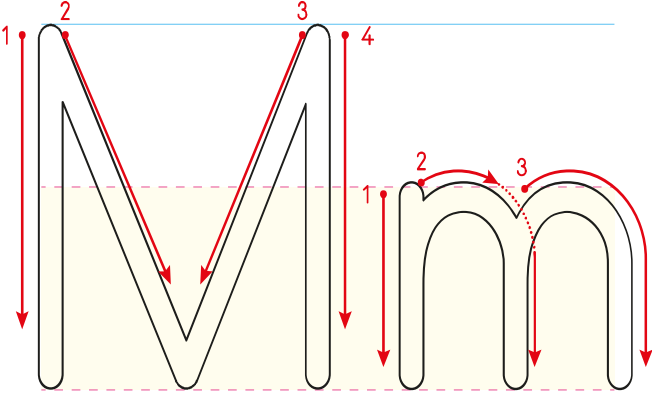

M M

m m m m m

m m m m

m

m

m

m



Okuyalım, yazalım.

e m em em em em

em

i m im im im im

im

o m om om om om

om

m e me me me me

me

m i mi mi mi mi

mi

m a ma ma ma ma

ma



Okuyalım, yazalım.

ma k mak mak mak

mak

me k mek mek mek

mek

ma ma mama mama mama

mama

mi nik minik minik minik

minik

Me lek Melek Melek Melek

Melek

Mi ne Mine Mine Mine

Mine



Okuyalım, yazalım.

el ma elma elma elma

elma

Ke mal Kemal Kemal Kemal

Kemal

ka lem kalem kalem kalem

kalem

Kemal elma al.

Kemal kalem al.

Okuyalım, yazalım.

e	mek		ek	mek	
em	lak		ki	lim	
li	mon		li	man	
E	min		Le	man	
lok	ma		ko	mik	

Okuyalım, görseli boyayalım.

Leman komik olma.

Al on iki lokma.

Emin iki ekmek alma.

İki kilo limon alma.



Okuyalım, yazalım.

m l e a

Blank writing area for the first word.

i n m i k

Blank writing area for the second word.

E e m l

Blank writing area for the third word.

o k m k

Blank writing area for the fourth word.

n m k a e

Blank writing area for the fifth word.

l i k i m

Blank writing area for the sixth word.

m e e k

Blank writing area for the seventh word.

M n i e

Blank writing area for the eighth word.

Heceleri eşleştirip kelimeler oluşturalım.

E

li

me

Blank writing area for the first word.

ma

mi

ne

Blank writing area for the second word.

ke

ki

ne

Blank writing area for the third word.

Okuyalım, yazalım.

Emine mont al.

Blank writing area for the first sentence.

İki kelime oku.

Blank writing area for the second sentence.

Makine on kilo.

Blank writing area for the third sentence.



☞ Karışık kelimelerden cümleler oluşturup yazalım.

al

Kemal

minik

lokma

Emel'i

Leman

anla

İlkem

ekleme

keke

limon

kilo

On

kemik

alma

Emin

in

Emel'le

limana

ekle

ilmek

Melek



Okuyalım, yazalım.

EMİN

Emin iki minik ekmek al.

On iki elma ile iki limon al.

Mont ile makine alma.

Ama keman al, kilim al.

Anneme iki kalem al.

Empty writing line for the word "EMİN".

Empty writing line for the word "EMİN".

Empty writing line for the word "EMİN".

Empty writing line for the word "EMİN".

Empty writing line for the word "EMİN".

Empty writing line for the word "EMİN".

☞ Görseli verilen varlıkların adını yazalım.

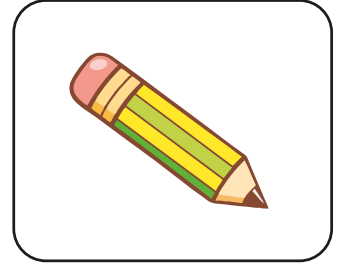
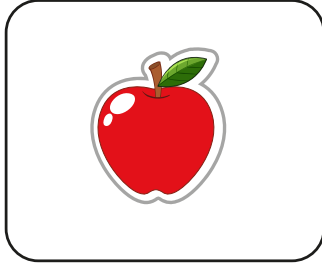
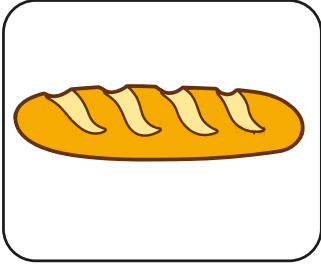

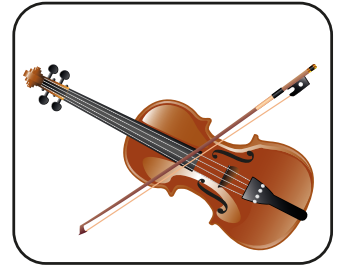
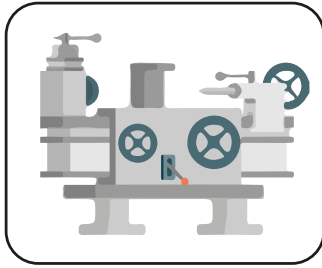

☞ Cümleleri doğru kelimelerle tamamlayalım.

ailem emekli kelime elleme kilim

Meltem iki _____ oku.

Nineme minik _____ al.

Emine nine _____ mi?

Mine'nin kalemini _____ .

Annem ile ninem _____ .



👉 7 rakamını yazalım.

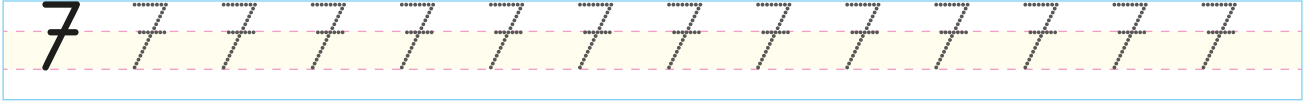
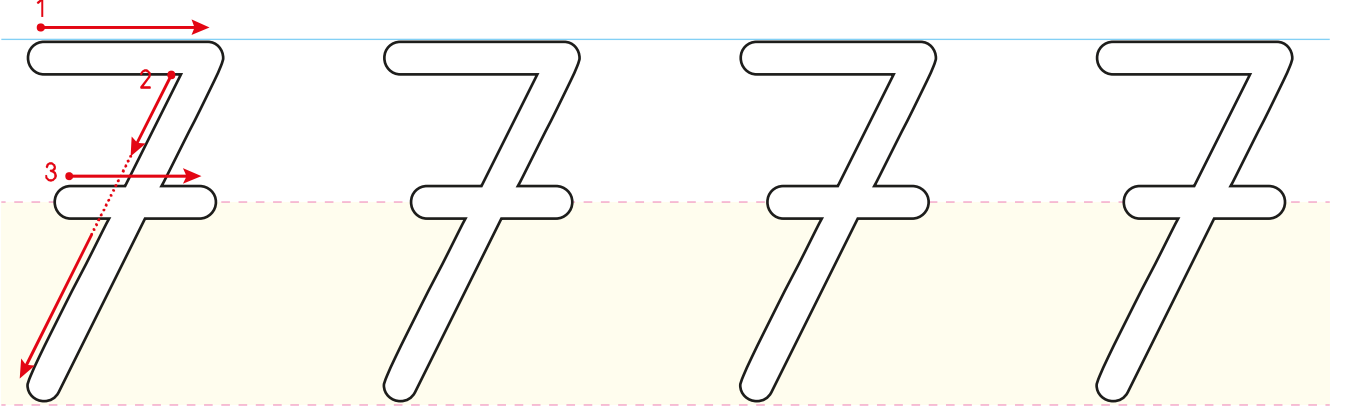



👉 Okuyalım, yazalım.

Okan Nil ile konakla.

Okan Nil ile konakla.

İki koli nane kolile.

İki koli nane kolile.



Nalan annene kano al.

Nalan annene kano al.

Yönergeleri uygulayalım.

- Adı "o" sesi ile başlayan varlıkların görselini sayfanın aşağısındaki görsellerden yapıştıralım.

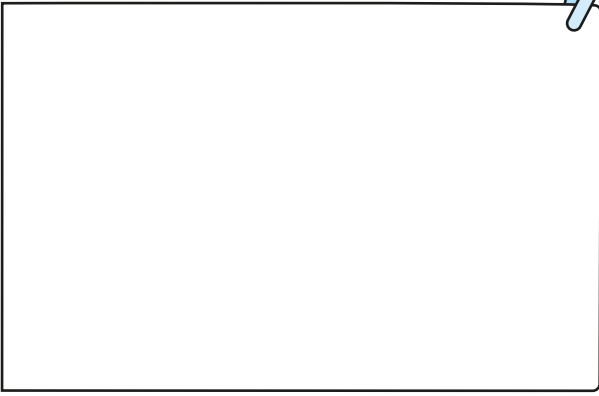

- Adı "o" sesi ile biten varlıkların görselini sayfanın aşağısındaki görsellerden yapıştıralım.

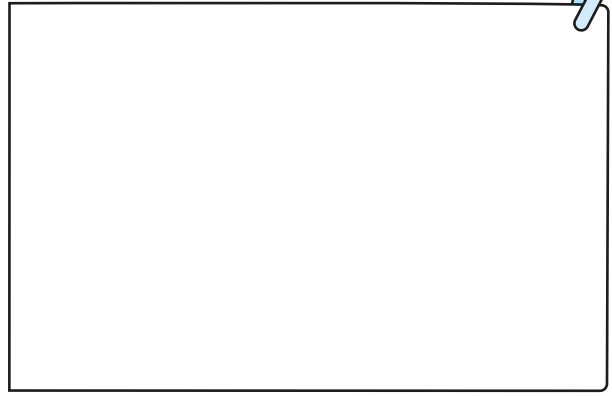

- Adında en çok "o" sesi olan görseli boyyalım.

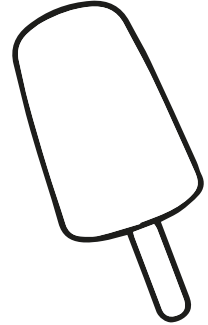
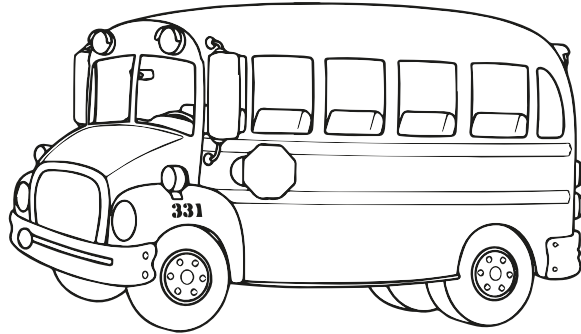
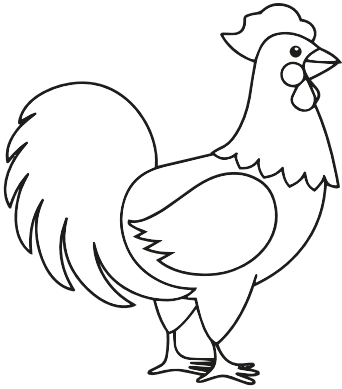

- Büyük "O" yazalım.

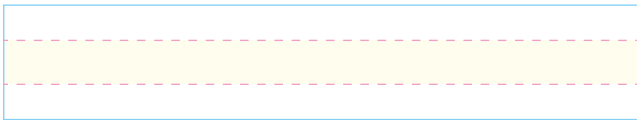
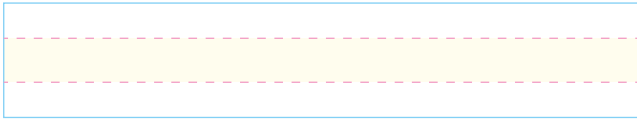

- Küçük "o" yazalım.

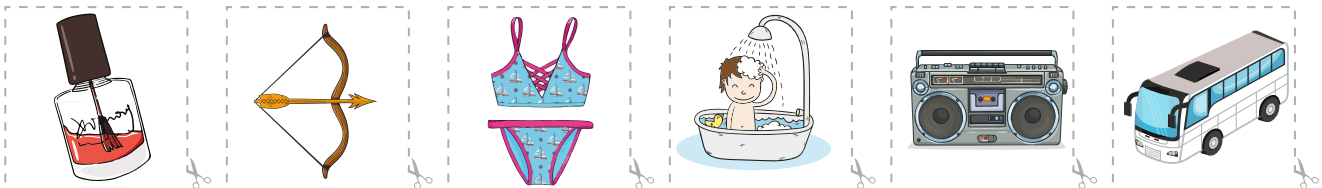
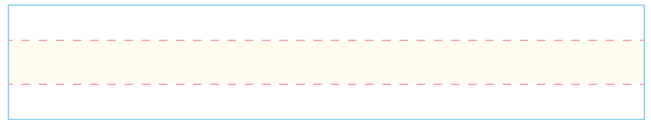
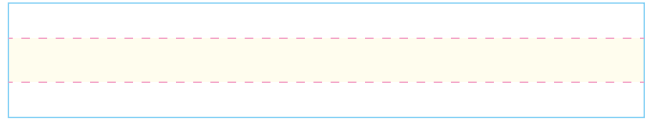



👉 Okuyalım, yazalım.

Kamil o kalem Emin'in.

Kamil o kalem Emin'in.

Mina ile limana inme.

Mina ile limana inme.

Kemal o makine kimin?

Kemal o makine kimin?

Yönergeleri uygulayalım.

- Adı "m" sesi ile başlayan varlıkların görselini sayfanın aşağısındaki görsellerden yapıştıralım.

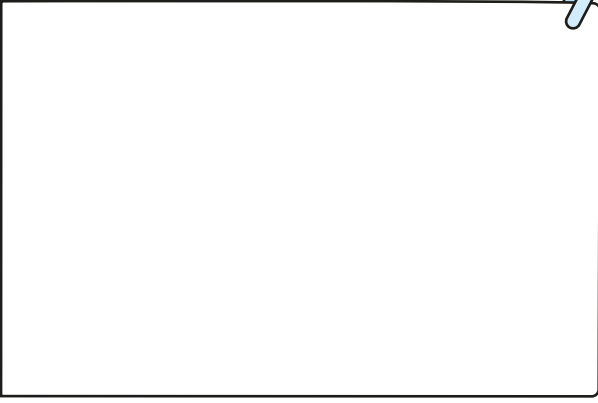

- Adı "m" sesi ile biten varlıkların görselini sayfanın aşağısındaki görsellerden yapıştıralım.

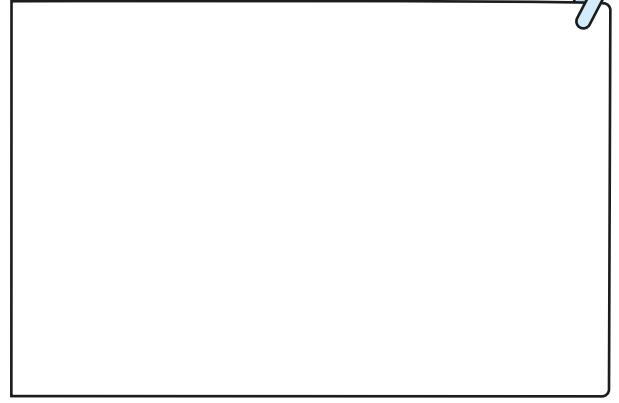

- Adında en çok "m" sesi olan görseli boyayalım.

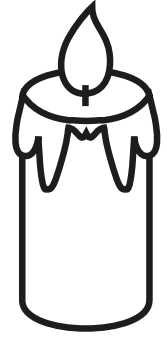
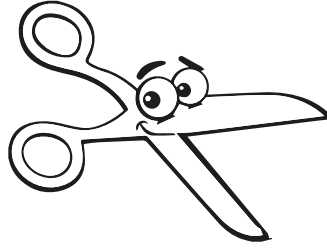

- Büyük "M" yazalım.

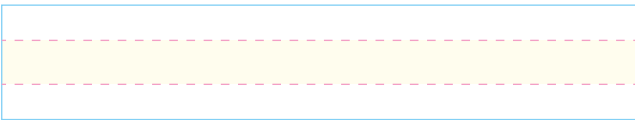
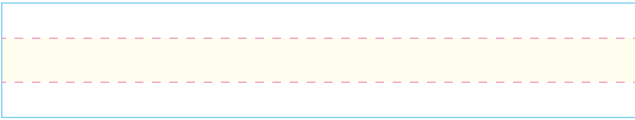

- Küçük "m" yazalım.

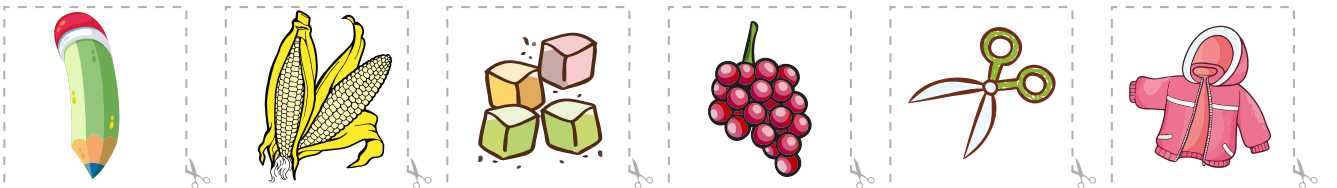

MATEMATİK

1

2

3

4

5

6

7

8

+

-

9

0

÷

×

=

?



👉 Varlıkları nesne sayılarıyla eşleştirelim.

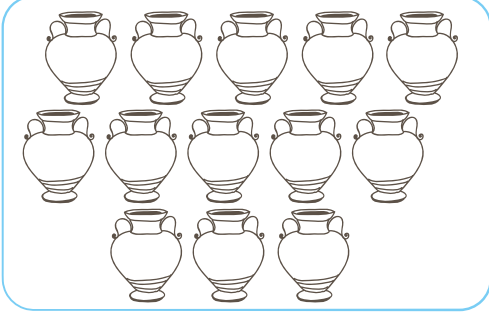

10

11

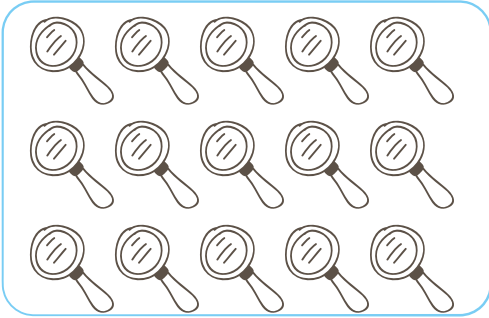

12

13

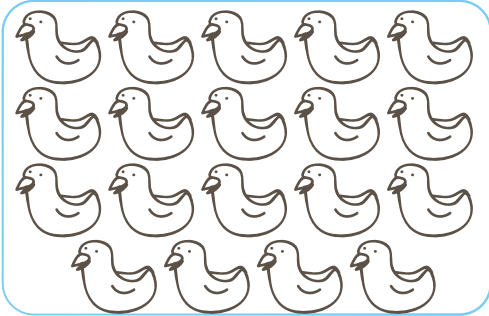

14

15

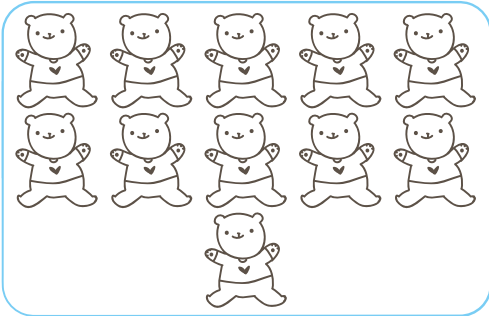

16

17

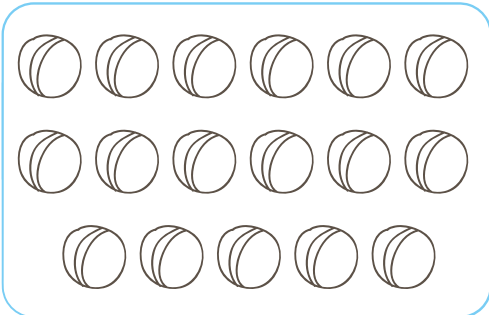

18

19

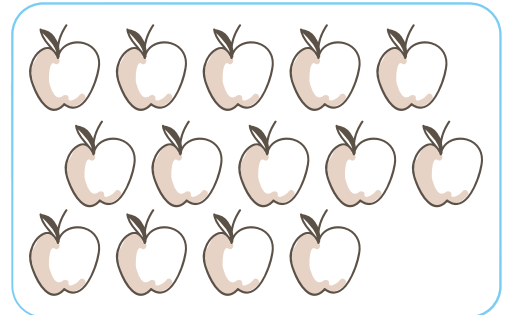
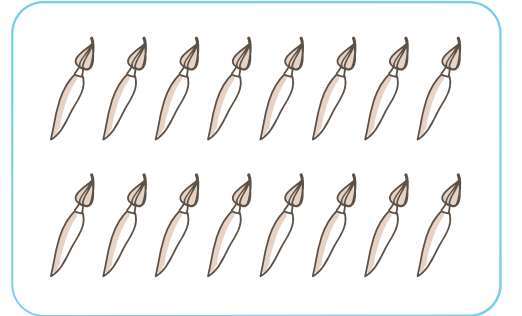
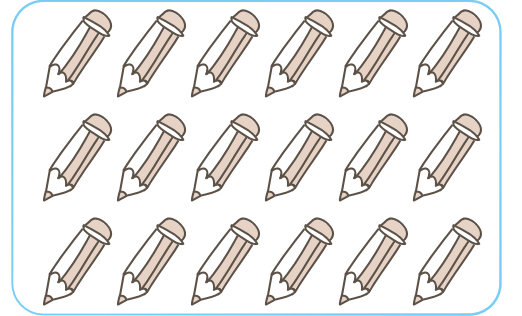
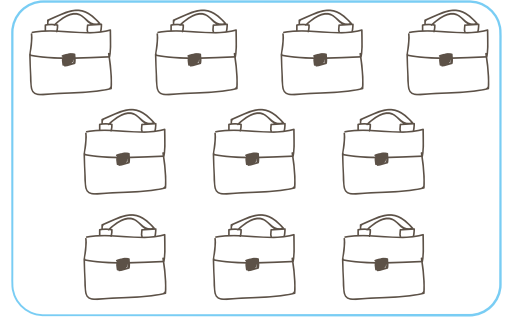
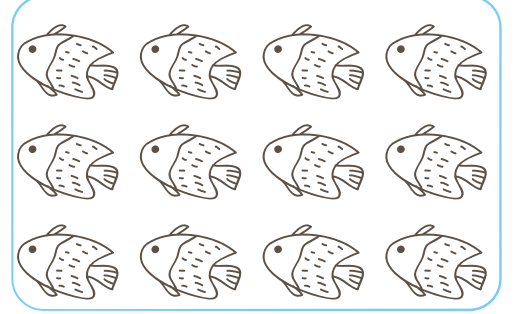

👉 Varlıkların sayısını yazalım.

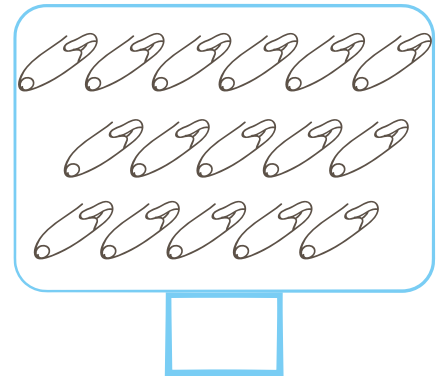
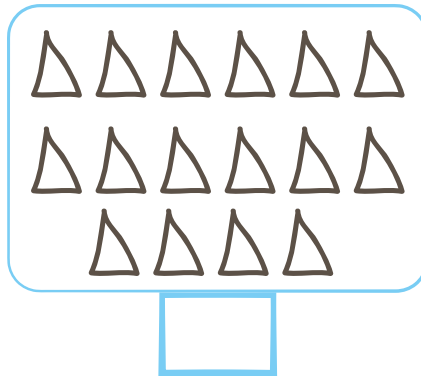
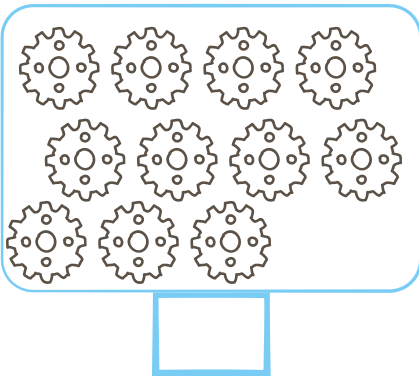
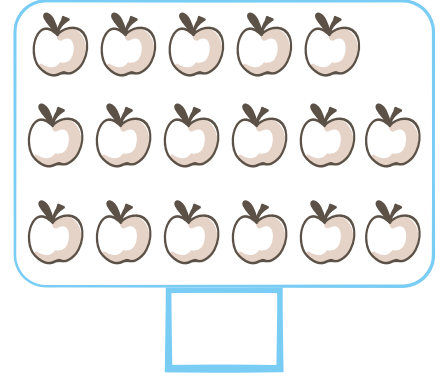
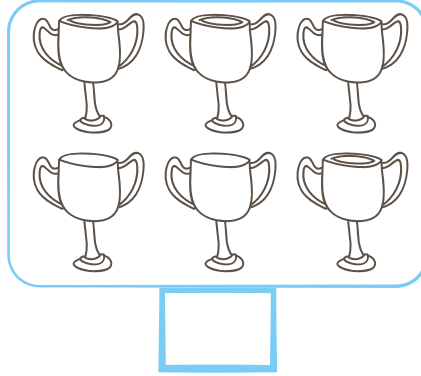
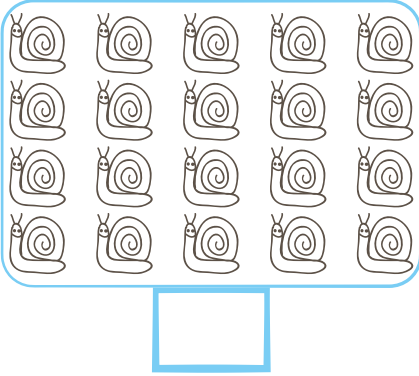
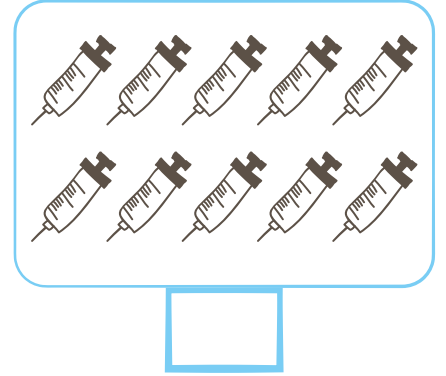
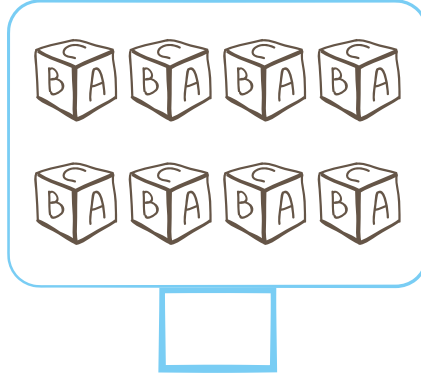
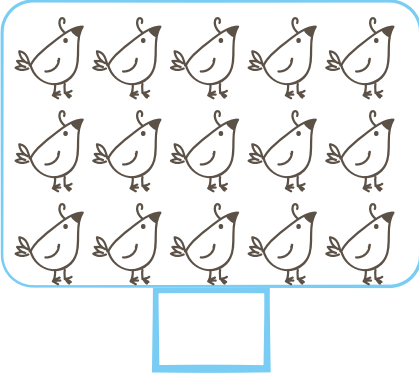
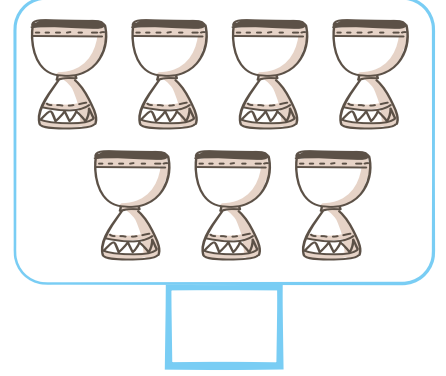
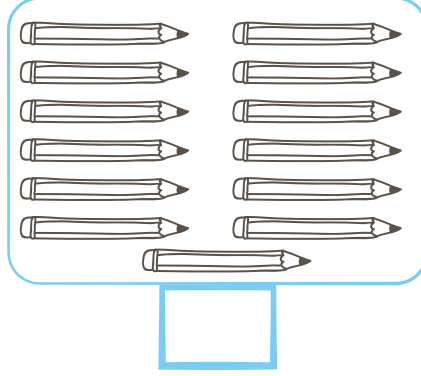
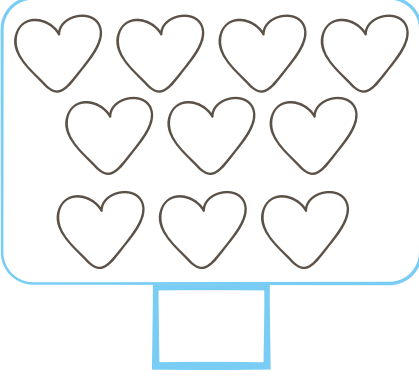



Kutulara belirtilen sayı kadar varlık çizelim.

14

12

19

20

11

15



Verilen sayılardan önce ve sonra gelen sayıları yazalım.

	6	
--	---	--

	15	
--	----	--

	3	
--	---	--

	9	
--	---	--

	18	
--	----	--

	11	
--	----	--

	10	
--	----	--

	2	
--	---	--

	8	
--	---	--

	19	
--	----	--

	14	
--	----	--

	16	
--	----	--

	4	
--	---	--

	6	
--	---	--

	8	
--	---	--

	15	
--	----	--

	7	
--	---	--

	5	
--	---	--

	10	
--	----	--

	11	
--	----	--

	17	
--	----	--

	13	
--	----	--

	12	
--	----	--

	5	
--	---	--

Verilen sayıların arasındaki sayıları yazalım.

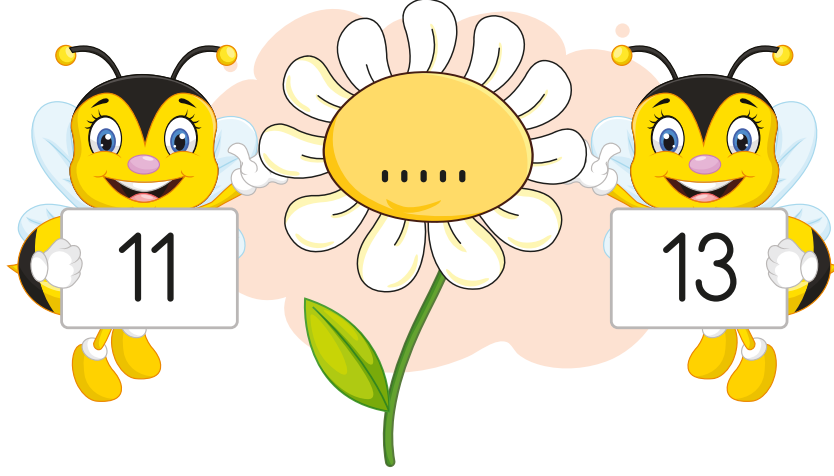

9		11
---	--	----

3		5
---	--	---

10		12
----	--	----

1		3
---	--	---

7		9
---	--	---

15		17
----	--	----

18		20
----	--	----

2		4
---	--	---

8		10
---	--	----

6		8
---	--	---

11		13
----	--	----

14		16
----	--	----

17		19
----	--	----

16		18
----	--	----

4		6
---	--	---

12		14
----	--	----

5		7
---	--	---

13		15
----	--	----

👉 Eksik sayıları tamamlayalım. Yönergeleri uygulayalım.

1		3		
			7	6
11	12			15
		18		



- 2'den önceki sayıyı mora boyayalım.
- 8'den sonraki sayıyı sarıya boyayalım.
- 6'dan önceki sayıyı maviye boyayalım.
- 17'den sonraki sayıyı pembeye boyayalım.
- 12 ile 14 arasındaki sayıyı griye boyayalım.
- 9 ile 11 arasındaki sayıyı kırmızıya boyayalım.
- 18 ile 20 arasındaki sayıyı siyaha boyayalım.