

👉 Varlıkların isimlerini söyleyelim. Görselleri boyayalım.

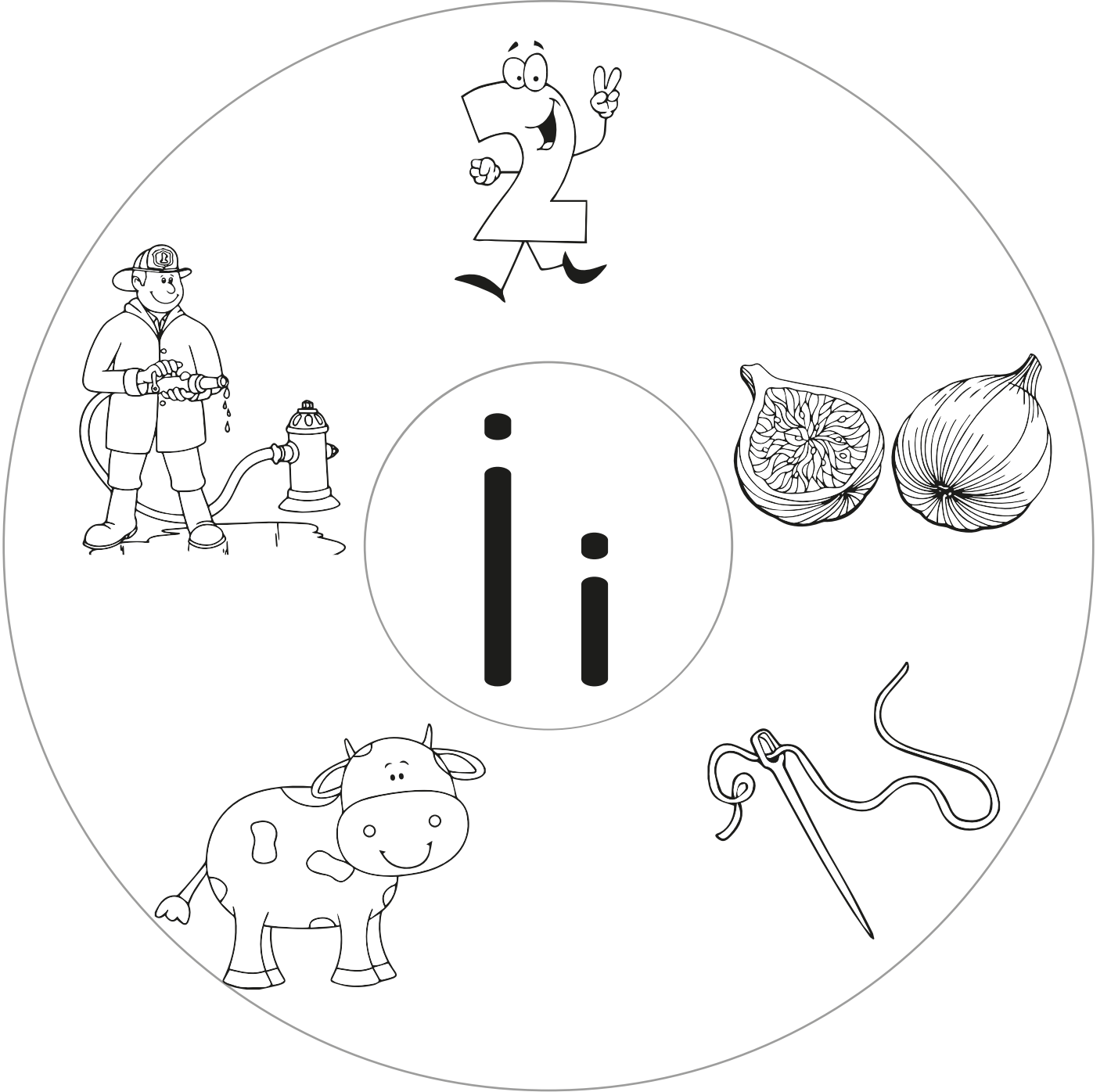

Adında "i" sesi bulunan varlıkları işaretleyelim.

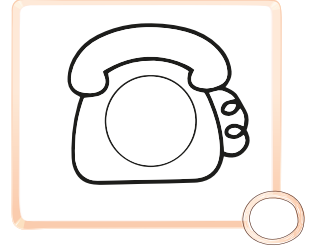
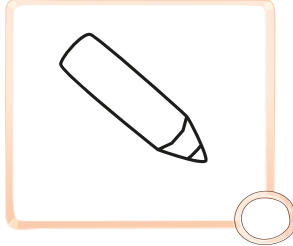
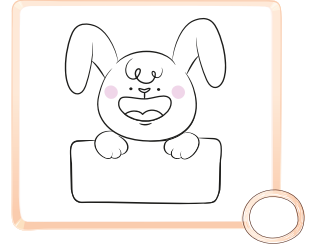
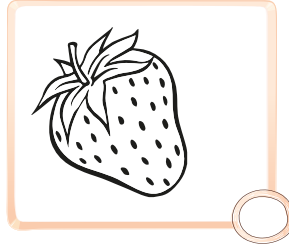
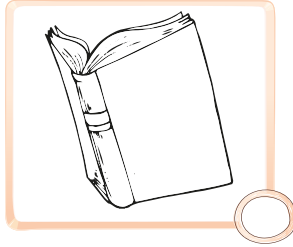
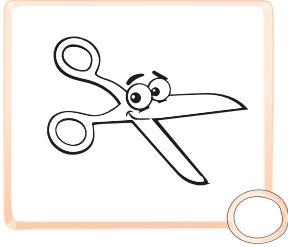
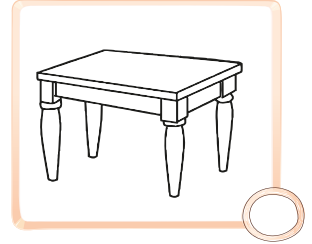
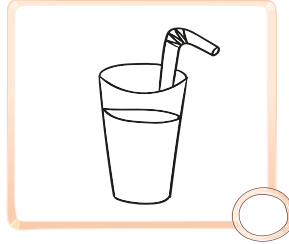
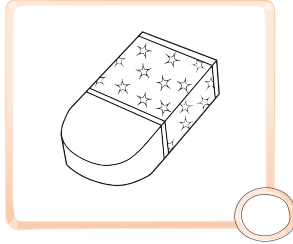
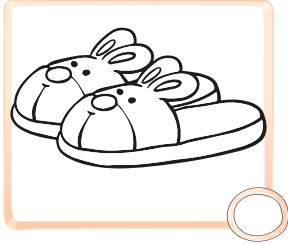

"i" sesi ile başlayan varlıkları boyyalım.

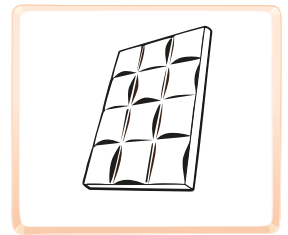
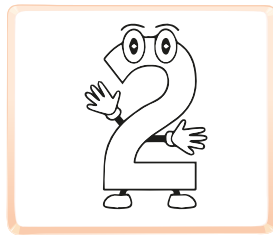
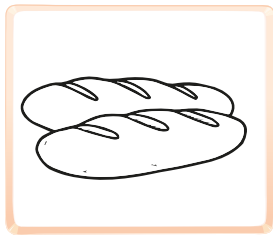
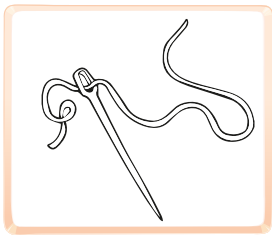
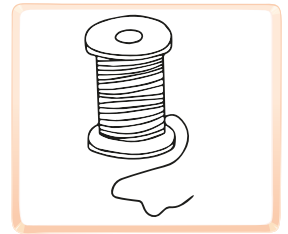
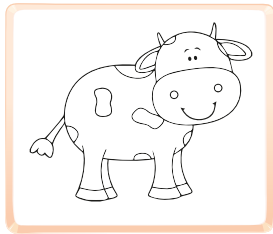
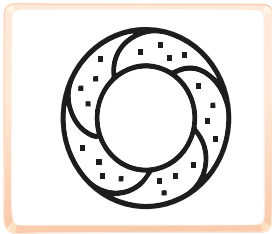
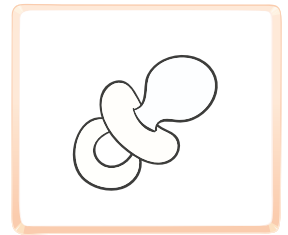
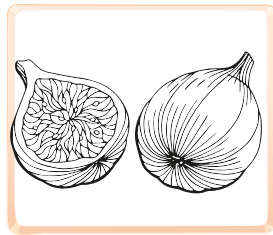
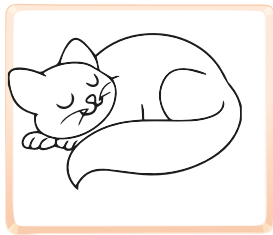
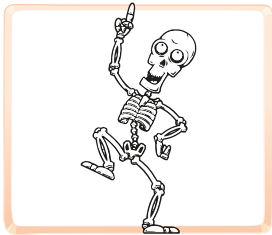

Varlıkların adındaki "i" sesi kadar şekil boyyalım.

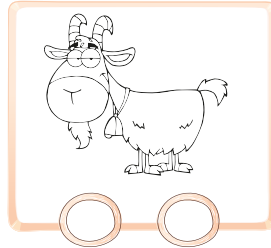
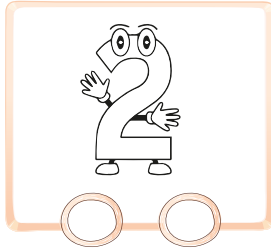
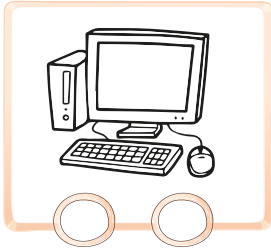
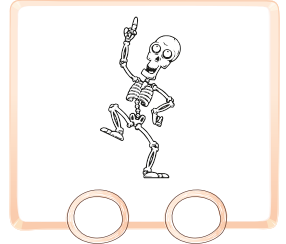
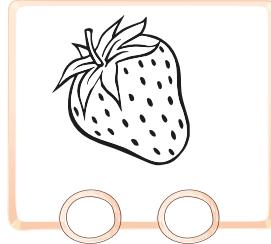
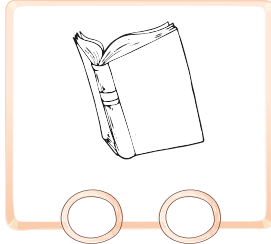
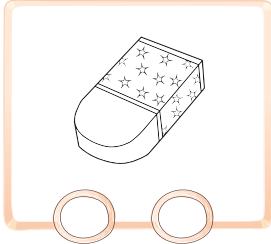
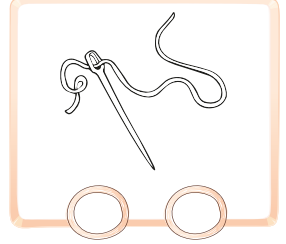
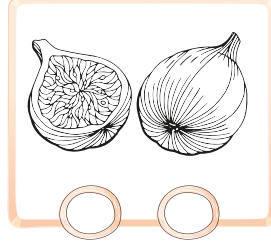
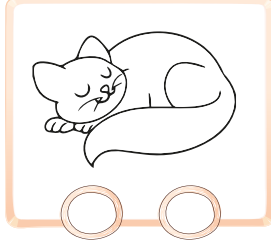
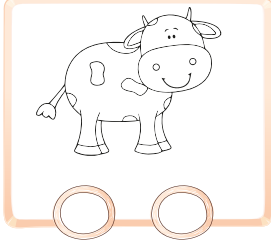

"i" harflerini yuvarlak içine alalım.





☞ Küçük "i" harfinin yazılış yönüne dikkat edelim. İçinden kalemimizle geçelim.

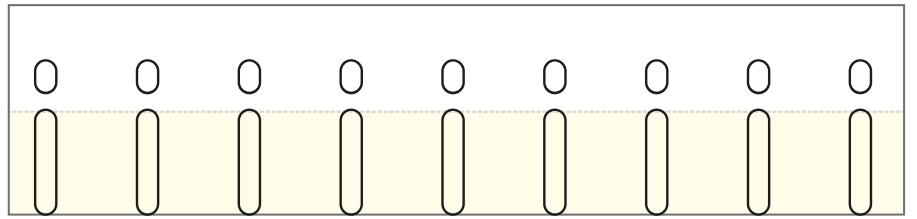
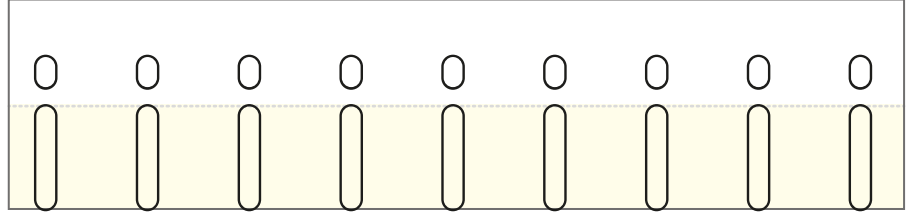
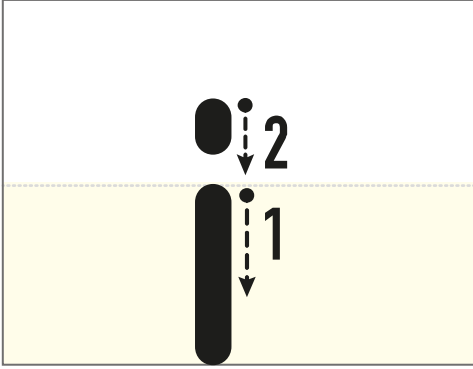

☞ "i" harfinin yazılı olduğu yıldızları boyayalım.



Yönergeleri uygulayalım.

• "i" harfini boyayalım.

• "i" harflerini bulup yuvarlak içine alalım.

i n i
e n
p t i
i i t

• Noktaları birleştirelim.

Yazma yönlerine dikkat ederek "i" harfini yazalım.



☞ "i" harfini yazalım.

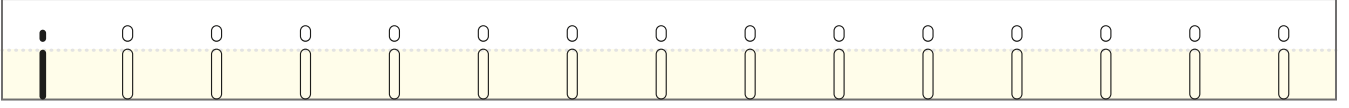

☞ Büyük "İ" harfinin yazılış yönüne dikkat edelim. İçinden kalemimizle geçelim.

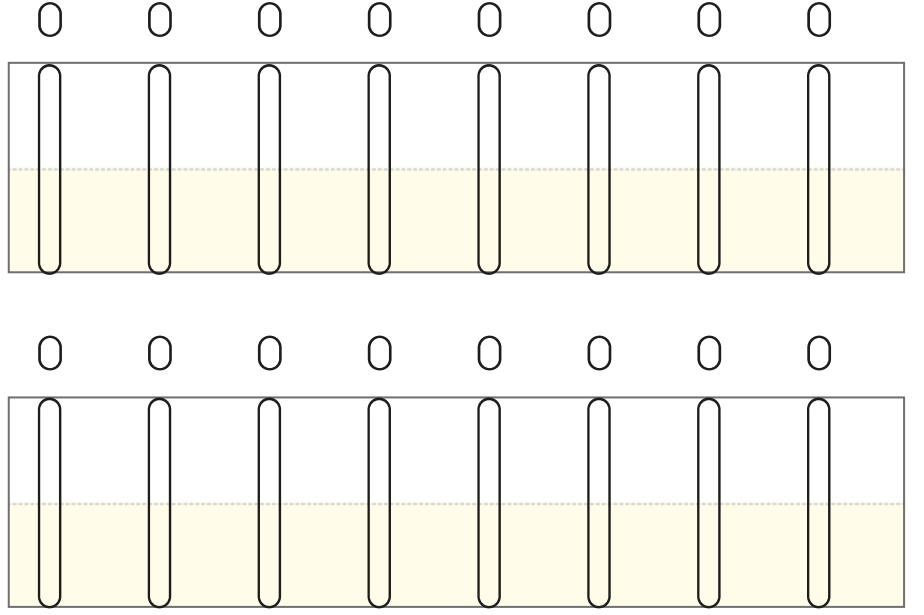
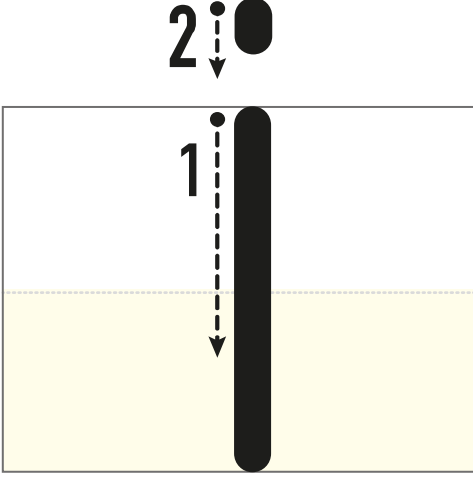

☞ "İ" harfinin yazılı olduğu balonları boyayalım.

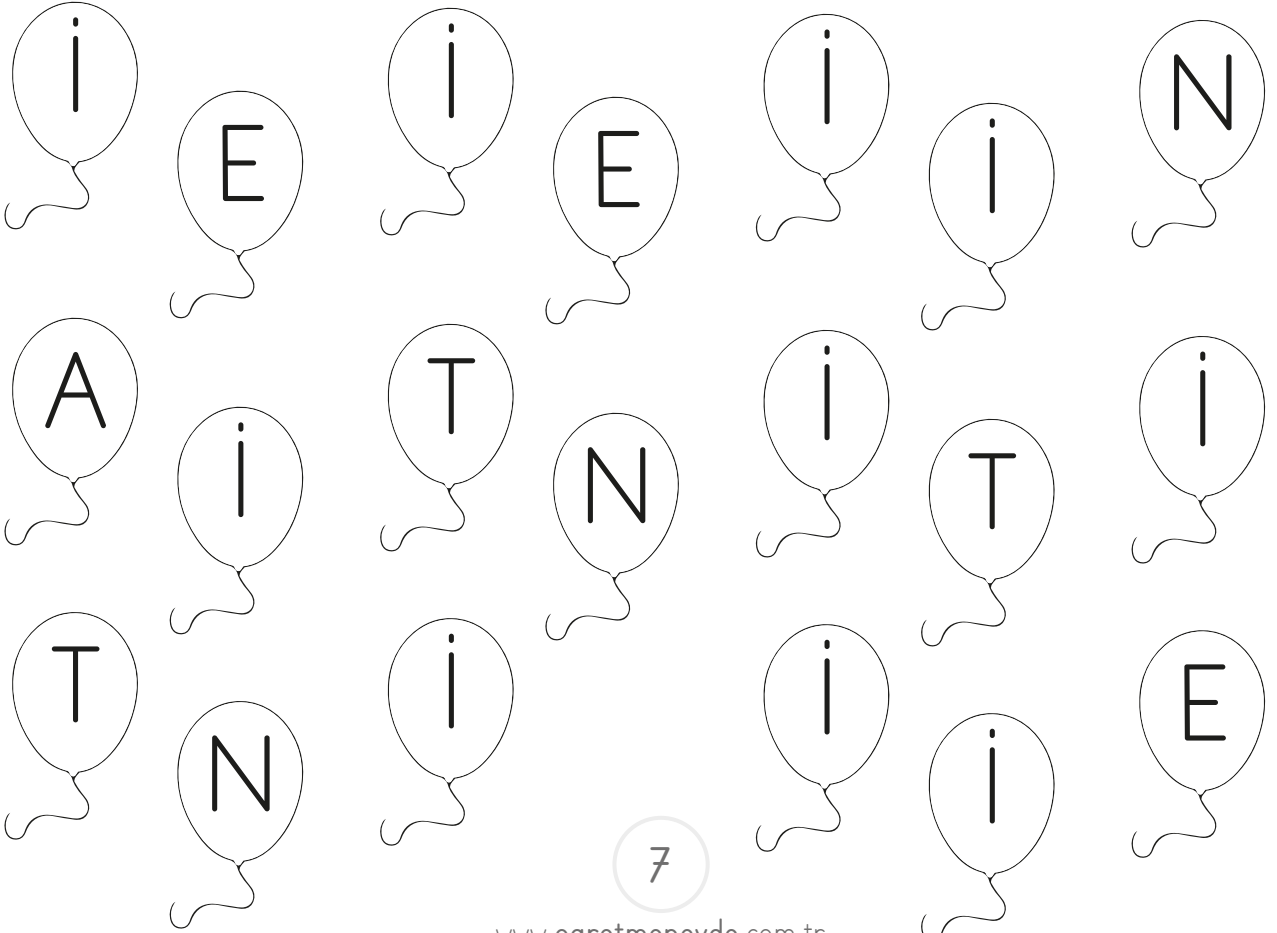

Yönergeleri uygulayalım.

• "i" harfini boyayalım.



• "i" harflerini bulup yuvarlak içine alalım.

i e i a
A n i i N
i i E a i

• Noktaları birleştirelim.

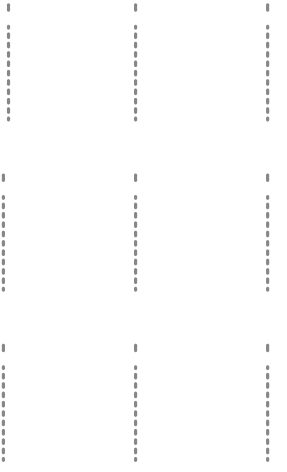

Yazma yönlerine dikkat ederek "i" harfini yazalım.

0 0 0 0 0 0 0

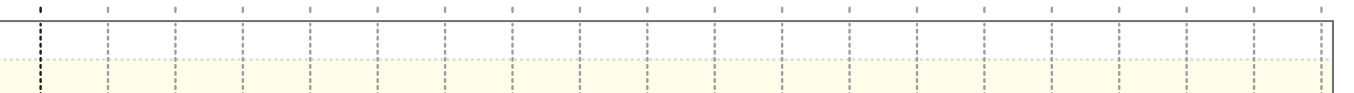
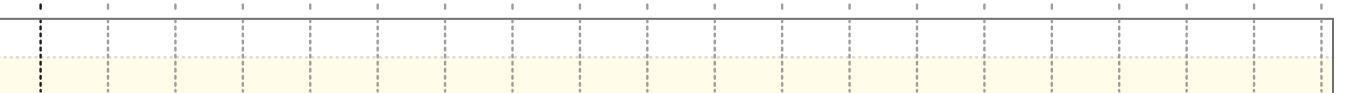
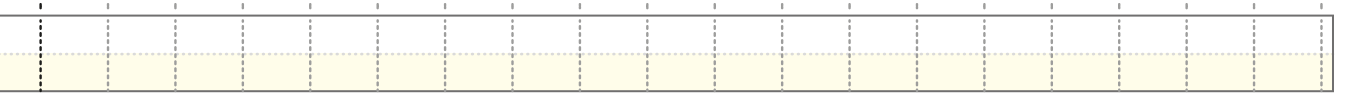
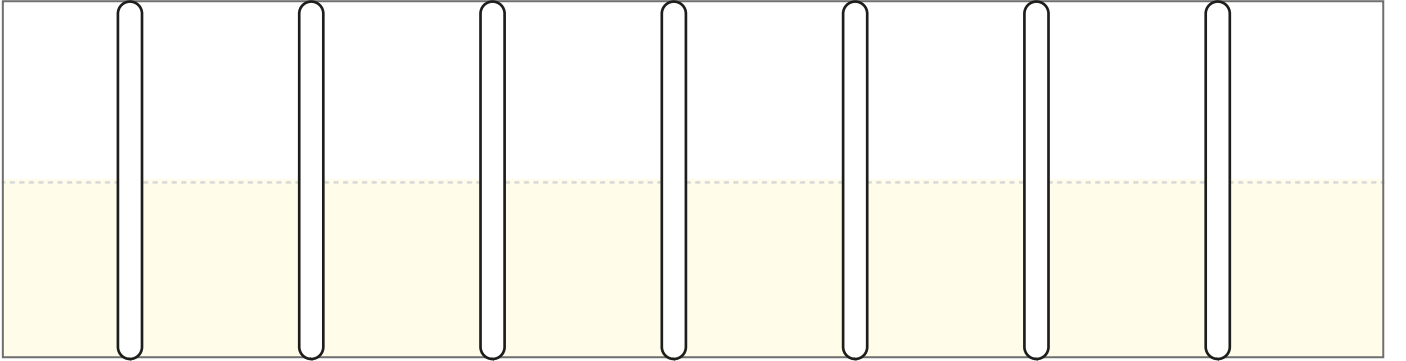



İ harfini yazalım.

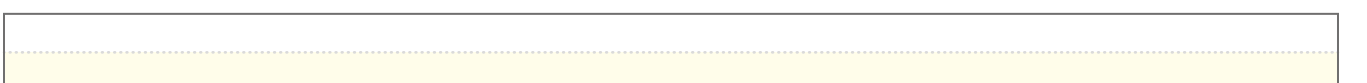
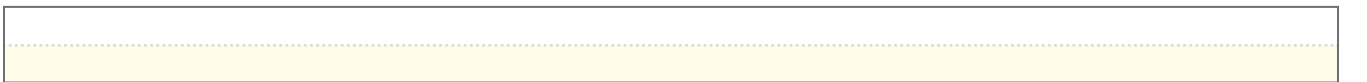
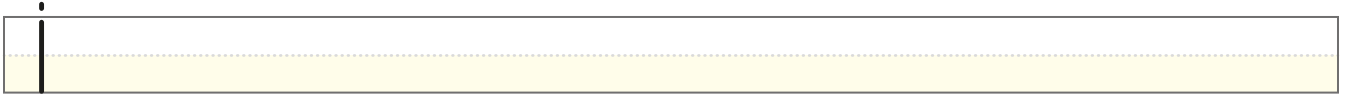
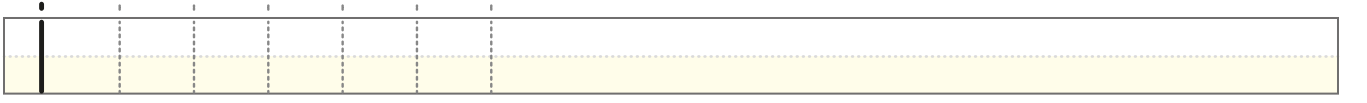
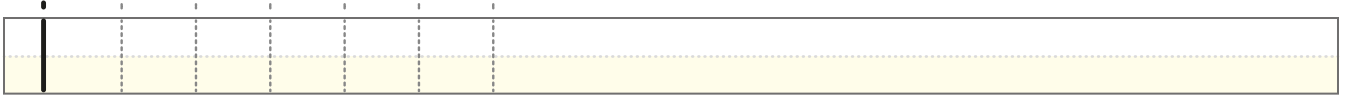
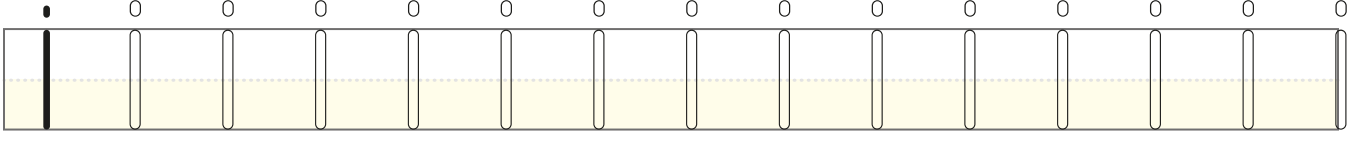

Renklere dikkat ederek görseli boyayalım.

Açık Yeşil i	Koyu Yeşil i	Sarı e	Kırmızı t	Mavi a	Mor n
-----------------	-----------------	-----------	--------------	-----------	----------





👉 Küçük "i" ve büyük "İ" harfini yazalım.

2 ↓ ●

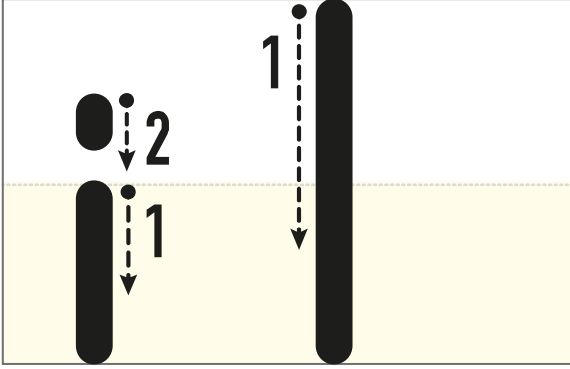

Tracing practice line for the lowercase letter 'i'.

Tracing practice line for the lowercase letter 'i'.

Tracing practice line for the lowercase letter 'i'.

Tracing practice line for the lowercase letter 'i'.

Tracing practice line for the lowercase letter 'i'.

Tracing practice line for the lowercase letter 'i'.

Tracing practice line for the lowercase letter 'i'.

Tracing practice line for the lowercase letter 'i'.

Tracing practice line for the lowercase letter 'i'.

Tracing practice line for the lowercase letter 'i'.

Tracing practice line for the lowercase letter 'i'.

Tracing practice line for the lowercase letter 'i'.



Okuyalım, yazalım.

i n in in in in

Blank handwriting practice line with a dashed midline.

Blank handwriting practice line with a dashed midline.

i t it it it it

Blank handwriting practice line with a dashed midline.

Blank handwriting practice line with a dashed midline.

n i ni ni ni ni

Blank handwriting practice line with a dashed midline.

Blank handwriting practice line with a dashed midline.

t i ti ti ti ti

Blank handwriting practice line with a dashed midline.

Blank handwriting practice line with a dashed midline.



Okuyalım, yazalım.

i n in

ti n tin

ni t nit

ti t tit

a ti ati

a ni ani

a it ait

ni ne nine

i nat inat

nin ni ninni

it tin ittin

☞ Kelimeyi bulmacaya yerleştirelim.

 ninni

 enine

 inan

 tane

 eti

 atına

 itti

 ani

 inatta

 itina

 anteni

 nine

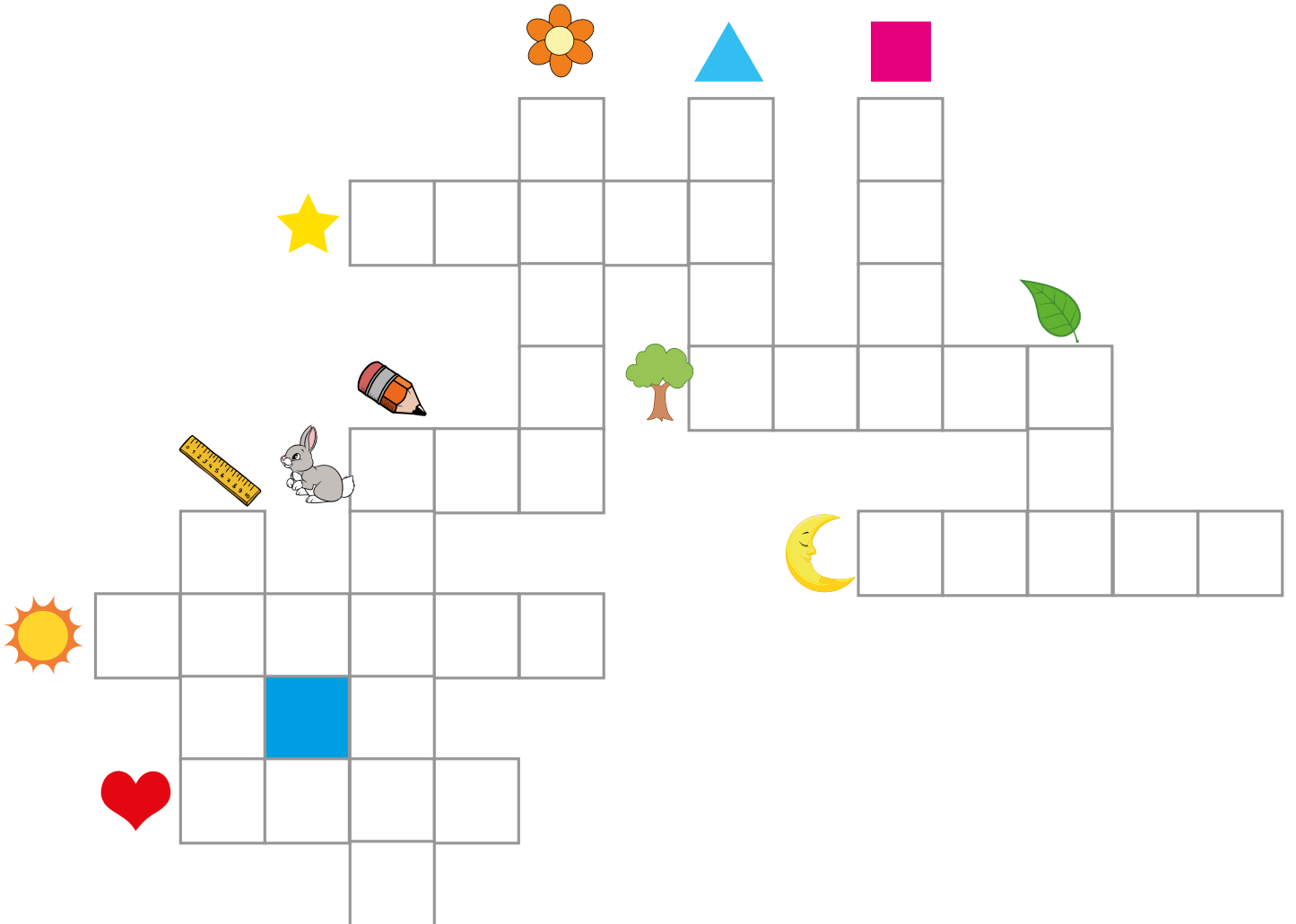

👉 Harflerle anlamlı kelimeler oluşturalım, yazalım.

neni

tnaii

inni

Blank writing area for the word 'neni'.

Blank writing area for the word 'tnaii'.

Blank writing area for the word 'inni'.

tnia

ntiei

atenin

Blank writing area for the word 'tnia'.

Blank writing area for the word 'ntiei'.

Blank writing area for the word 'atenin'.

👉 Aşağıdaki boşluklara meyvelere ait olan ses veya heceleri yazalım ve okuyalım.

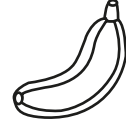
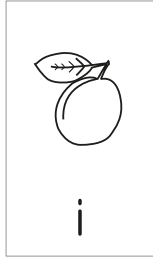
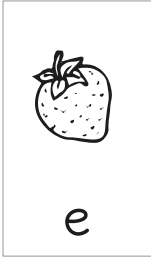
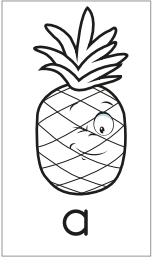
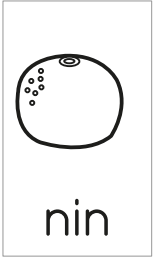

Blank writing area for the words 'nin' and 'a'.

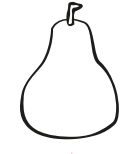
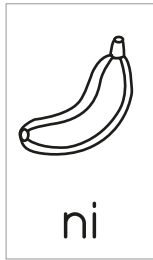
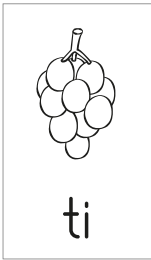
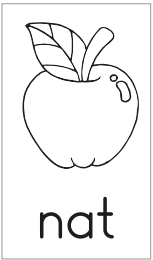
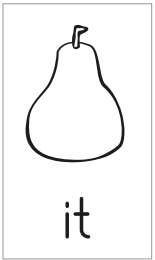

Blank writing area for the words 'it', 'nat', 'ti', and 'ni'.

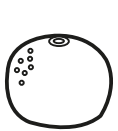

Blank writing area for the words 'nin' and 'a'.



Blank writing area for the words 'i', 'nat', and 'ni'.

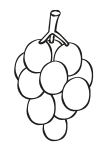

Blank writing area for the words 'e', 'ti', and 'ni'.



👉 5 rakamını yazalım.

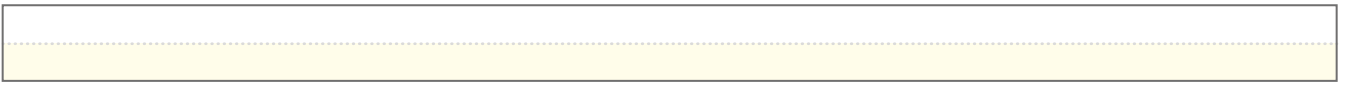
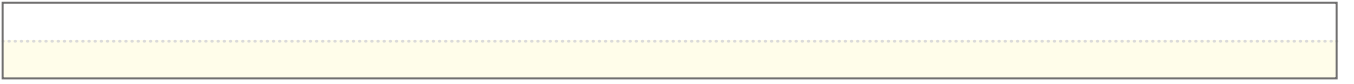
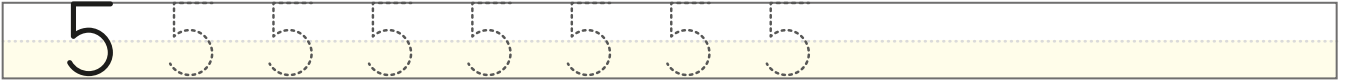
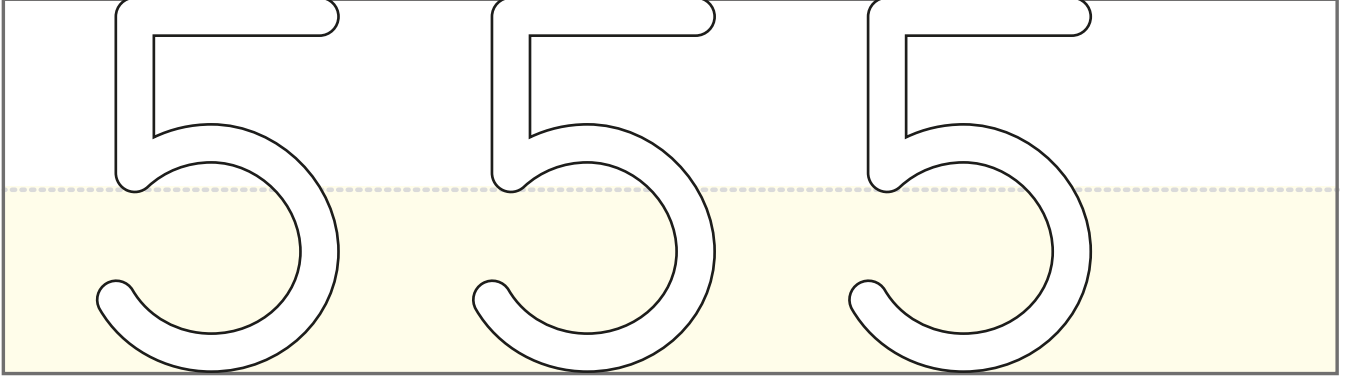

MATEMATİK

1

2

3

4

5

6

7

8

+

-

9

0

÷

×

=

?





11

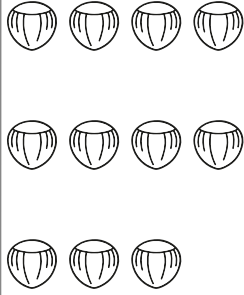

11 11 11

12

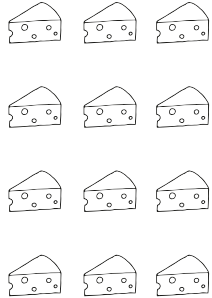

12 12 12

13

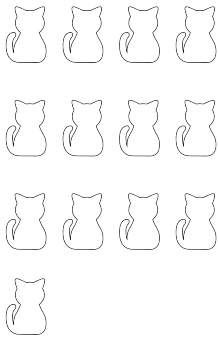

13 13 13

14

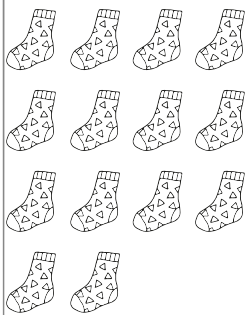

14 14 14

15

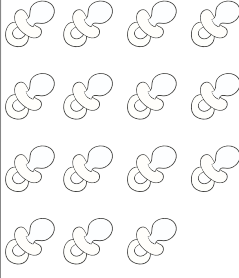

15 15 15

Blank handwriting practice lines for the number 15.

16

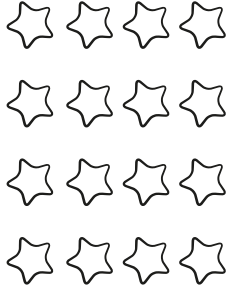

16 16 16

Blank handwriting practice lines for the number 16.

17

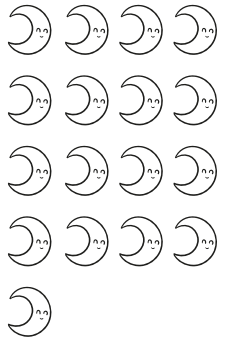

17 17 17

Blank handwriting practice lines for the number 17.

18

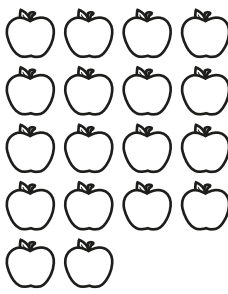

18 18 18

Blank handwriting practice lines for the number 18.

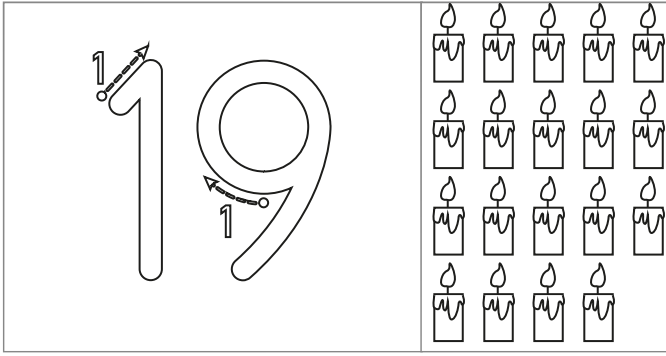

19 19 19

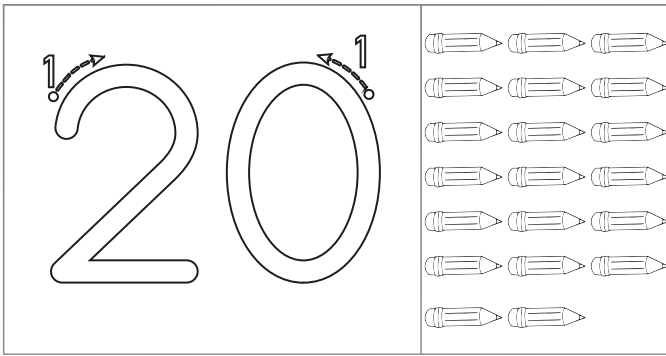

20 20 20





👉 Sayıları maviye, rakamları pembeye boyayalım.

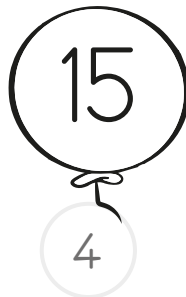
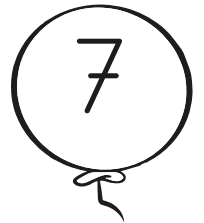
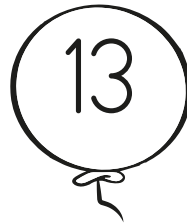
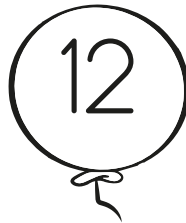
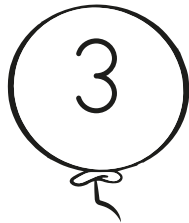
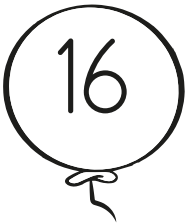
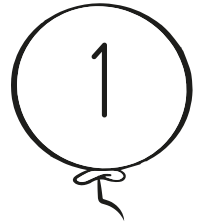
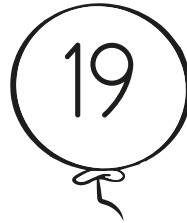
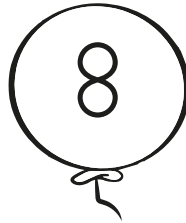
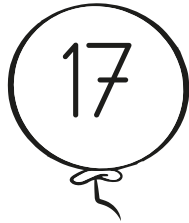
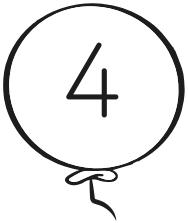
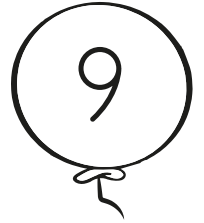
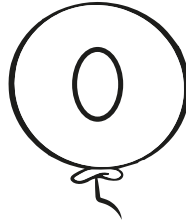
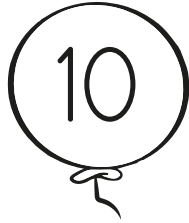
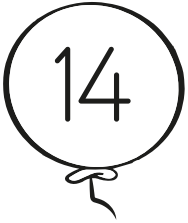
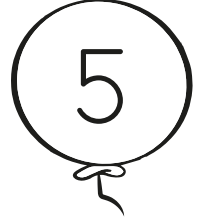
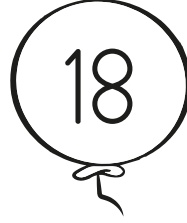
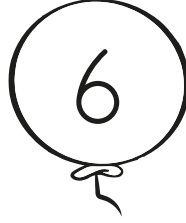
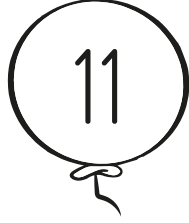



Varlıkların sayısını yazalım.

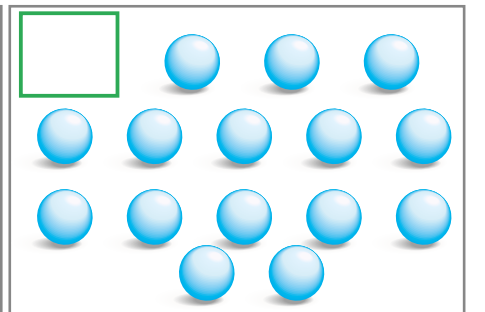
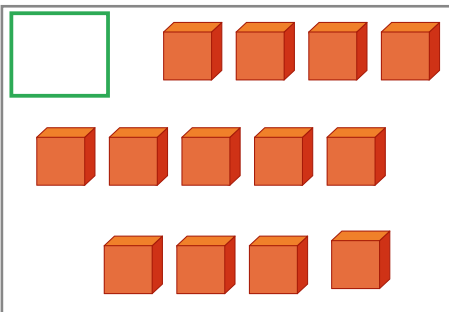
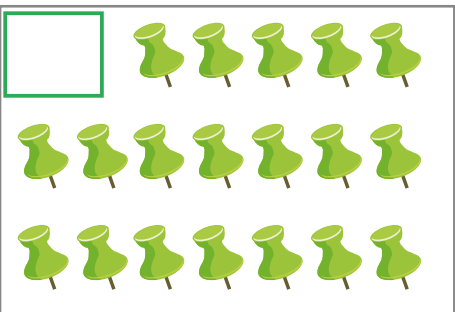
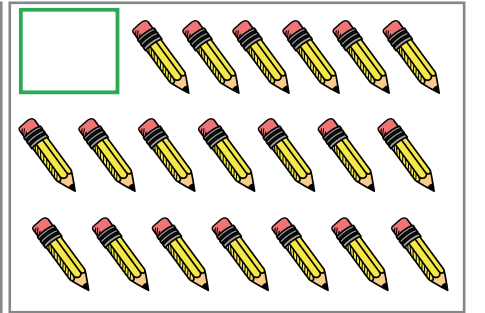
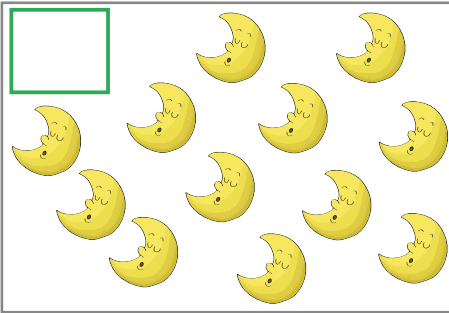
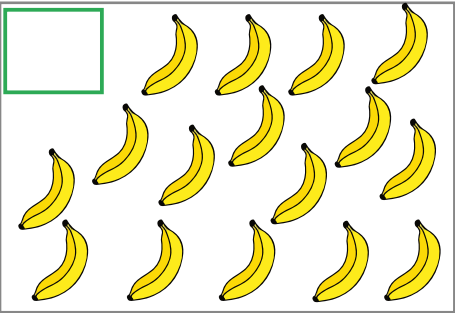
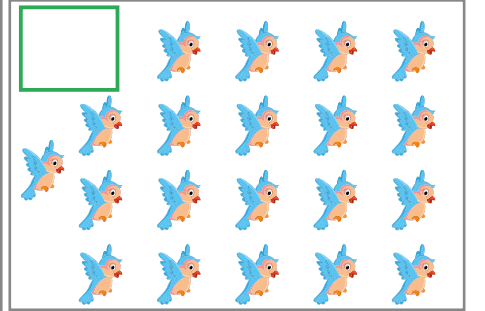
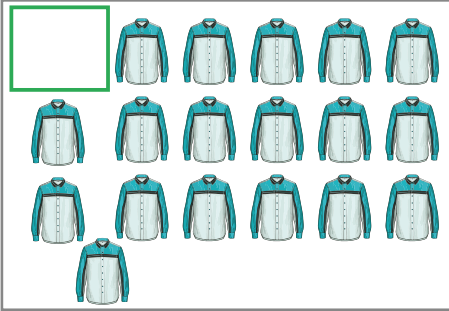
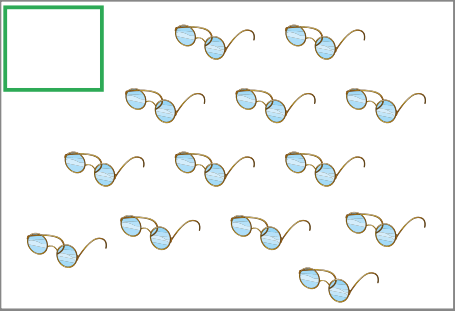
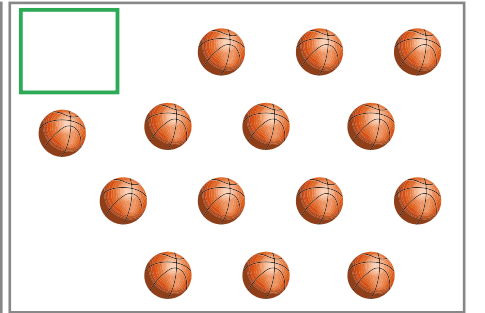
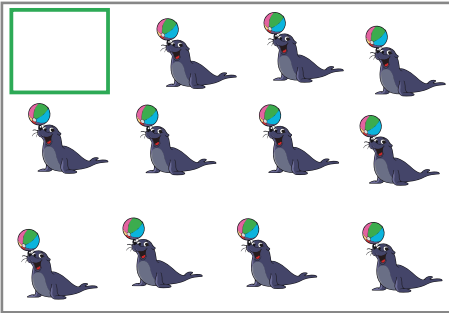
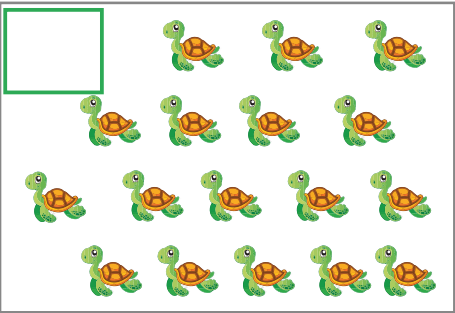
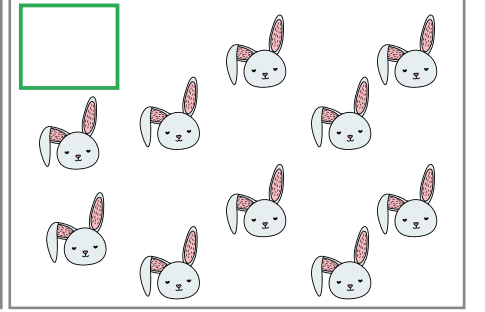
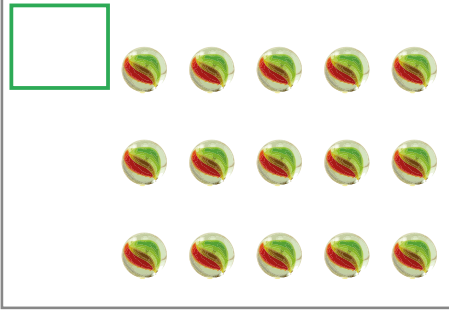
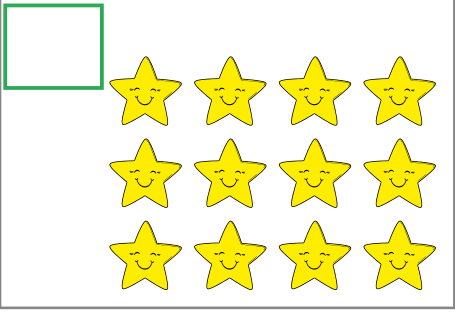



Verilen sayı kadar şekil çizelim.

13 	15	12
10	7	14
20	8	16
6	11	9
14	5	17

👉 Aşağıda verilen sayılardan önce ve sonra gelen sayıları noktalı yerlere yazalım.

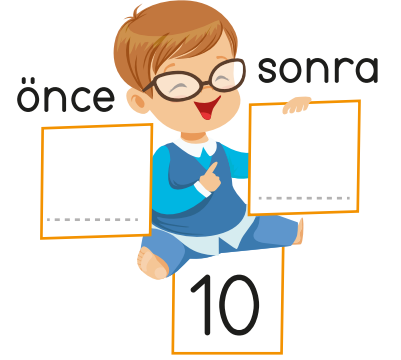
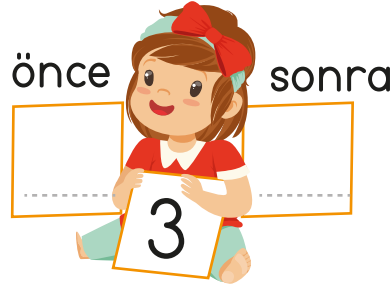
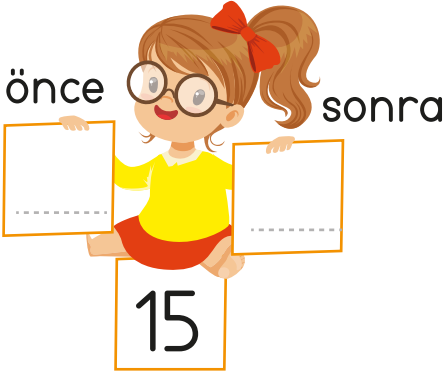
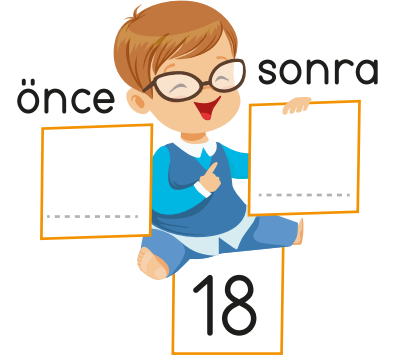
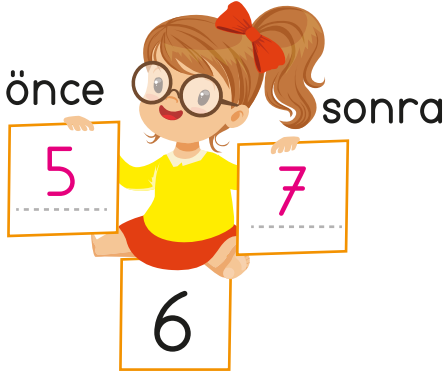

👉 Fincanlardaki sayıların arasına gelmesi gereken sayıları demliklerin üzerine yazalım.





 Boş kutulara gelecek sayılar yazalım.

	5	
--	---	--

	12	
--	----	--

	9	
--	---	--

2		4
---	--	---

8		10
---	--	----

7		9
---	--	---

	15	
--	----	--

	19	
--	----	--

	6	
--	---	--

1		3
---	--	---

10		12
----	--	----

16		18
----	--	----

	2	
--	---	--

	10	
--	----	--

	14	
--	----	--

9		11
---	--	----

18		20
----	--	----

5		7
---	--	---

	16	
--	----	--

	3	
--	---	--

	8	
--	---	--

11		13
----	--	----

17		19
----	--	----

14		16
----	--	----